



PRICE LIST 2023-2024

EFFECTIVE
2023-03-01

Our Snowblower Price List and our Agricultural Products / Dump Trailers Price List are now merged together.

Published once a year, our new Pronovost Price List is effective March 1st to February 28 of the following year and includes all our products.

Les Machineries Pronovost inc.
Let's go forward !

260, Haut du Lac Sud (route 159)
Saint-Tite, Quebec, Canada GOX 3H0
Tel.: 418 365-7551
Fax : 418 365-7954
www.pronovost.qc.ca
info@pronovost.qc.ca

Agricultural Products and Dump Trailers on the back.

2023_LP02

SNOWBLOWERS

PUMA & LYNX
PRIVATE USERS CATEGORY

PRONOVOST
CONTRACTORS CATEGORY

INDUSTRIAL
PUBLIC WORKS CATEGORY



INNOVATIONS FOR 2023

- Cyclone C9228 New design.
- Puma-84 to Puma-96 with 3 point hitch ISO Cat.2.
- 500 HP reducer option for PGV-120137 to PGV-1202TRC.
- Higher 3 point hitch option for Cyclone C8026.
- 1000/540 reducer option for Puma-84 to Puma-96.

INNOVATIONS FOR 2022

- New model C7224 in the Cyclone Series.
- Hydraulic flotation ski option for snowblower, to compact the first layer of snow.
- Rear mount scraper blade option on Puma inverted series.
- PC3C-GR1 chute option on Group I snowblowers.
- Standard sealed guard on P-82126-HP.
- Ice scraper blade option on the Pronovost series, Groups I, II, III.
- Hose kit on sand and salt spreaders.



- ✓ See our snowblowers in action.
- ✓ Learn more about our snowblowers.
- ✓ Compare models.
- ✓ Find the right snowblower for you.



LesMachineriesPronovost



machineriespronovost



Pronovostinc

Copyright © Les Machineries Pronovost Inc., 2023

All rights reserved.
Printed in Canada.



TABLE OF CONTENTS

DETAILS

At your service	4
Important points.....	5
Power Take Off Warranty.....	6

PRIVATE USERS CATEGORY

Lynx Snowblowers	7
Puma Snowblowers.....	9
Puma Inverted Snowblowers.....	10
Characteristics and options.....	14

CONTRACTORS CATEGORY

Pronovost Snowblowers - Group I	15
Pronovost Snowblowers - Group II.....	19
Pronovost Snowblowers - Group III.....	25
Pronovost double ribbon; large open flight auger series -GV	29
Pronovost Snowblowers - PXPL / X-PRO	33
Cyclone Snowblowers	37
Pronovost Snowblowers - Inverted P-INV	41
Characteristics and options.....	44

PUBLIC WORKS CATEGORY

Semi-industrial Snowblowers - PGS Group I.....	47
Semi-industrial Snowblowers - PGS Group III	49
Industrial Snowblowers - Open flight auger PGV.....	53
Industrial Snowblowers - Full flight auger	57
Sidewalk Snowblower - Open flight auger	61
Sidewalk Snowblower - Full flight auger	64
Sidewalk Snowblower - Open flight auger P-54126-GV	67
Characteristics and options.....	70

OTHER PRODUCTS

Hydraulic Snowblowers.....	73
Hardy Sand and Salt Spreader.....	74
Hydraulic wheels for snowblowers	76
Ice scraper blade for snowblowers.....	77
Hydraulic flotation ski for snowblowers.....	78

OTHER INFORMATION

Technical information	79
- Weight changes for PXPL Snowblowers	79
- Choice of scraper blade for Pronovost Snowblowers	79
- Choice of skid shoe for Pronovost Snowblowers.....	79
Charts	80
- Height table for chutes PC3C, PSIG & PCG	80
- Height table for chutes PCT & PCTC-INDR	81
Combos	82
We are Pronovost.....	90



Donald Michaud, MBA
CEO
d.michaud@pronovost.qc.ca
Phone: 418 365-7551 ext. 2112



Marie Turgeon
Sales director / Customer experience
m.turgeon@pronovost.qc.ca
Phone: 418 365-7551 ext. 2117



Stéphan Dubé
Territory manager
s.dube@pronovost.qc.ca
Cellphone: 819 247-0054



Sheila Duggan
Internal Sales Clerk - Machinery
s.duggan@pronovost.qc.ca
Phone: 418 365-7551 ext. 2113



Shirley Greer
Logistics coordinator and customer services
s.greer@pronovost.qc.ca
Phone: 418 365-7551 ext. 2104



René Béland
Parts manager
r.beland@pronovost.qc.ca
Phone: 418 365-7551 ext. 2103



Côte Marcotte
Inside Sales Representative - Parts
c.marcotte@pronovost.qc.ca
Phone: 418 365-7551 ext. 2135



Alain Corriveau
Inside Sales Representative - Parts
a.corriveau@pronovost.qc.ca
Phone: 418 365-7551 ext. 2114



IMPORTANT POINTS TO CONSIDER WHEN SELLING A SNOWBLOWER

1	MAKE SURE THAT THE RECOMMENDED HORSEPOWER FOR THE SELECTED SNOWBLOWER CORRESPONDS TO THE HORSE POWER OF THE TRACTOR.
	Situations which can occur if the tractor used is not powerful enough : <ul style="list-style-type: none">- The snowblower is too heavy for the tractor.- The snowblower is difficult to maneuver.- The speed is difficult to maintain and the chute is frequently blocked.- Insufficient performance of the snowblower.
	Situations which can occur if the tractor is too powerful : <ul style="list-style-type: none">- Premature failure of the snowblower.- The snow overflows on each side of the snowblower.- Drive line angle is too steep and premature failure of the u-joints and yokes.
2	DRIVE LINE OPTIONS
	Drive line upgrade to a higher capacity : <ul style="list-style-type: none">- For intensive use.- When the tractor is in the upper range of the recommended horsepower for the snowblower.- To extend the working life of the drive line when the working angle is moderate.
	Multilobe drive line : <ul style="list-style-type: none">- Increase the sliding capacity of the tubes.
	* A version with a special shear bolt is available for the 1000 RPM. * It is highly recommended to use winter grease on driveline components to insure lubrication in frigid temperatures.
3	REDUCERS 1000/540 RPM
	Use of the 1000/540 RPM speed reducer is recommended in the following situations : <ul style="list-style-type: none">- When recommended by the tractor manufacturer according to the operator's manual.- Can decrease the angle of the drive line versus the height of the PTO.- To increase the capacity and working life of the drive line.
4	FULL FLIGHT MAIN AUGER OPTIONS
	Use of a full flight serrated auger is recommended in the following situations : <ul style="list-style-type: none">- Heavy duty use.- In hardened snow and icy conditions.<ul style="list-style-type: none">⇒ If the horsepower of the tractor allows it because the snowblower requires 10% to 20% more horsepower to be operated.⇒ If the weight of the snowblower is not a problem.
5	WEIGHT OF THE SNOWBLOWER
	Check the weight of your tractor and the lifting capacity of the three-point so as not to exceed the maximum load when mounting the selected snowblower. Also make sure to maintain a good traction on the ground on all four wheels. Ballast can be used if needed.



POWER TAKE OFF WARRANTY

POWER TAKE OFF WARRANTY

INFORMATION ON THE WARRANTY OF THE PTO SHAFTS

The PTO shafts are warranted by the **manufacturer**. This warranty covers only manufacturing defects in material and workmanship, and is conditional to recommended use and installation only.

The life expectancy of a PTO shaft including components such as yokes, u-joints and tubes depend on many factors which cannot be controlled by Les Machineries Pronovost inc.

Factors directly affecting the life of a PTO shaft :

- Pronounced working angle.
- Angle of the snowblower to the ground.
- Frequency of lubrication and grease type used.
- Intermittent or continuous work cycle.
- Proper usage by the operator.
- Speed of rotation.

If one or more of the above mentioned situations applies, our snowblower price list proposes, as options, different solutions :

- Upgrade PTO shafts.
- PTO shafts with Multilobe Tubes.
- Installation of the snowblower at 1000 RPM instead of 540 RPM with the use of a reduction gear box to decrease the angle of the PTO shaft and / or decrease the load on the tractor's transmission.

IMPORTANT: When using a 1000/540 speed reducer, be sure to use a 10 mm shear bolt or a 12 mm shear bolt reduced to 3/8" according to model of drive shaft (PTO).



PRIVATE USERS CATEGORY

LYNX SNOWBLOWERS



HP recommended : 16 to 25 HP PTO



INCLUDED IN COMBO PRICE

- ✓ Chute.
- ✓ Manual deflector.
- ✓ Chute rotation kit according to your choice, manual (rod included) hydraulic (cylinder included) or electric rotation on some models (motor included).
- ✓ Standard PTO.
- ✓ Welded scraper blade.
- ✓ Adjustable skid shoes.
- ✓ Pronovost red color.



SUGGESTED RETAIL

HP	MODEL	MANUAL ROTATION	CYLINDER ROTATION	ELECTRIC ROTATION
		-RMAN	-RCYL	-RELE
16 to 25	LYNX-52	3,712. \$	4,078. \$	4,268. \$
16 to 25	LYNX-62	3,755. \$	4,121. \$	4,311. \$
16 to 25	LYNX-70	3,787. \$	4,153. \$	4,343. \$
25 to 40	LYNX-74	5,571. \$	6,013. \$	-

ADJUSTMENT FOR CHUTE DEFLECTOR			RETAIL PRICE
LYNX-52 to LYNX-70	25TR04	Hydraulic cylinder.	161. \$
	AE-04	Electric actuator.	757. \$
LYNX-74	25TR08	Hydraulic cylinder.	164. \$

HOSE KIT		RETAIL PRICE	
	FOR HYDRAULIC CYLINDER ROTATION		FOR DEFLECTOR CYLINDER
LYNX-52 to LYNX-70	PKB-PU4872-RC 260. \$	PKB-PU4872-C	273. \$
LYNX-74	PKB-PU7680-RC 287. \$	PKB-PU7680-C	287. \$

* Installation not included.

CHARACTERISTICS AND OPTIONS ILLUSTRATED ON PAGE 14.

FREIGHT CHARGES	F.O.B. St-Tite - Refer to the list of shipping costs.
------------------------	-------------------------------------------------------

WARRANTY : One (1) year on manufacturing defects - void if product has been altered or misused. The PTO shaft warranty is given by the manufacturer and applies only to manufacturing defects. Prices and Specifications subject to change without notice. ALL TAXES EXTRA WHEN APPLICABLE.



SPECIFICATIONS					
MODEL		LYNX-52	LYNX-62	LYNX-70	LYNX-74
Recommended HP (HP PTO)		16 to 25			25 to 40
Working width	in. mm	52" 1320	62" 1574	70" 1778	74" 1880
Cutting height	in. mm	25" 635			29" 737
Hitch category		1			1 & 2
Drum diameter	in. mm	21" 533			22" 559
Depth of drum	in. mm	6" 152			8" 203
Drum wall		High quality steel			
Number of impeller blades		4			
Impeller shaft diameter	in. mm	1" 25			1 1/4" 32
Height - impeller center	in. mm	13" 330			14" 356
Impeller RPM		540 RPM			
Required RPM for the tractor PTO		540 RPM			
Number of augers		1			
Main auger diameter	in. mm	14" 356			16 1/2" 419
Bearing / ductile iron casting	in. mm	1" 25			1 1/4" 32
Drive chain - main auger		50			60
Number of shear bolts		1 for impeller + 1 for auger			
PTO		T20			T40
Scraper blade		High quality steel, welded			
		3/8" x 1"		3/8" x 1 1/2"	
Adjustable skid shoes		High quality steel			
Chute		Regular			
Chute rotation	Manual	MD-4872			MD-74
	Hydraulic cylinder	HRD-4872			HRD-74
	Electric motor	ERD-4872			-
Chute rotation maximum angle	Manual rotation	255°			280°
	Hydraulic cylinder rotation	240°			250°
	Electric rotation	255°			-
Antifriction for chute		Blocks			
Deflector		Manual			
- Option hydraulic cylinder		25TR04			25TR08
- Option electric actuator		AE-04			-
Color		Pronovost red			
Storage support		✓			
Weight including chute	lbs kg	275 125	308 140	323 147	472 215

Design and specifications subject to change without notice.



PUMA SNOWBLOWERS



HP recommended : 18 to 125 HP PTO



INCLUDED IN COMBO PRICE

- ✓ Chute with 2 hinged deflectors (CPUSI-4872, CPUSI-7480 or CPUSI-8496).
- ✓ Chute base on antifriction ring.
- ✓ Manual deflector.
- ✓ Chute rotation kit with rod, cylinder or motor according to the model selected (manual, cylinder, motor or electric rotation).
- ✓ Standard PTO shaft.
- ✓ Welded scraper blade.
- ✓ Adjustable skid shoes.
- ✓ Pronovost Red color.

SUGGESTED RETAIL

HP	MODEL	MANUAL ROTATION	CYLINDER ROTATION	MOTOR ROTATION	ELECTRIC ROTATION
		-RMAN	-RCYL	-RMOT	-RELE
18 to 22	PUMA-48	4,278. \$	4,644. \$	4,913. \$	4,834. \$
18 to 22	PUMA-54	4,367. \$	4,733. \$	5,002. \$	4,923. \$
18 to 25	PUMA-64	4,558. \$	4,924. \$	5,193. \$	5,114. \$
20 to 30	PUMA-72	4,800. \$	5,166. \$	5,435. \$	5,356. \$
25 to 40	PUMA-76	6,125. \$	6,567. \$	6,797. \$	-
30 to 45	PUMA-80	6,401. \$	6,843. \$	7,073. \$	-
40 to 75	PUMA-84	7,745. \$	8,217. \$	8,456. \$	-
50 to 75	PUMA-94	8,195. \$	8,667. \$	8,906. \$	-
80 to 125	PUMA-96	10,200. \$	10,672. \$	10,911. \$	-

AJUSTMENT FOR CHUTE DEFLECTOR			RETAIL PRICE
PUMA-48 to PUMA-72	25TR04	Hydraulic cylinder.	161. \$
	AE-04	Electric actuator	757. \$
PUMA-76 to PUMA-80	25TR04	Hydraulic cylinder.	161. \$
PUMA-84 to PUMA-96	25TR08	Hydraulic cylinder.	164. \$

HOSE KIT		→ NEW ←				RETAIL PRICE
	FOR HYDRAULIC CYLINDER ROTATION		FOR HYDRAULIC MOTOR ROTATION		FOR DEFLECTOR CYLINDER	
PUMA-48 to PUMA-72	PKB-PU4872-RC	260. \$	PKB-PU4872-RM	189. \$	PKB-PU4872-C	273. \$
PUMA-76 to PUMA-80	PKB-PU7680-RC	287. \$	PKB-PU7680-RM	191. \$	PKB-PU7680-C	287. \$
PUMA-84 to PUMA-96	PKB-PU8496-RC	300. \$	PKB-PU8496-RM	191. \$	PKB-PU8496-C	280. \$
* Installation not included.						

ACCELERATOR			RETAIL PRICE
PUMA-48 & PUMA-54	PUACC-4854	Accelerator 540/756 (ratio 1:1.4) (25 HP).	1,614. \$
PUMA-64 & PUMA-72	PUACC-6472	Accelerator 540/756 (ratio 1:1.4) (45 HP).	1,614. \$



INVERTED PUMA SNOWBLOWERS



HP recommended : 18 to 50 HP PTO

INCLUDED IN COMBO PRICE

- ✓ Chute with 2 hinged deflectors (CPUSI-4872-IV and CPUSI-7480-IV).
Base on antifriction ring.
- ✓ Manual deflector (hydraulic cylinder for deflector now in option).
- ✓ Chute rotation kit with motor according to the model selected (hydraulic or electric rotation).
- ✓ Inverted PTO shaft.
- ✓ Welded scraper blade.
- ✓ Adjustable skid shoes.
- ✓ Pronovost red color.

SUGGESTED RETAIL

HP	MODEL INVERTED	MOTOR ROTATION	ELECTRIC ROTATION
		-RMOT	-RELE
18 to 30	PUMA-64-IV	7,297. \$	7,218. \$
18 to 30	PUMA-72-IV	7,394. \$	7,315. \$
30 to 50	PUMA-74-IV	9,353. \$	-
30 to 50	PUMA-80-IV	9,533. \$	-

AJUSTMENT FOR CHUTE DEFLECTOR			RETAIL PRICE
PUMA-64-IV to PUMA-72-IV	25TR04	Hydraulic cylinder.	161. \$
	AE-04	Electric actuator	757. \$
PUMA-74-IV to PUMA-80-IV	25TR04	Hydraulic cylinder.	161. \$

HOSE KIT				RETAIL PRICE	
	FOR HYDRAULIC MOTOR ROTATION		FOR BOTH MOTOR ROTATION & DEFLECTOR CYLINDER		FOR REAR MOUNT SCRAPER BLADE
Puma-64-IV Puma-72-IV	PKB-PU6472-IVRM	267. \$	PKB-PU6472-IV	512. \$	PKB-PU6472-IVL 377. \$
Puma-74-IV Puma-80-IV	PKB-PU7480-IVRM	270. \$	PKB-PU7480-IV	519. \$	PKB-PU7480-IVL 404. \$
* Installation not included.					

REAR MOUNT SCRAPER BLADE AND OPTIONS					PRIX DÉTAIL
	PUMA-64-IV	PUMA-72-IV	PUMA-74-IV	PUMA-80-IV	
Rear mount scraper (welded scraper blade).	PUMA-64-IVL 551. \$ <small>Weight : 52 lbs / 24 kg</small>	PUMA-72-IVL 572. \$ <small>Weight : 55 lbs / 25 kg</small>	PUMA-74-IVL 626. \$ <small>Weight : 76 lbs / 34 kg</small>	PUMA-80-IVL 665. \$ <small>Weight : 80 lbs / 36 kg</small>	
Kit of chains for rear mount scraper blade.	INVL-CH-92102 103. \$	INVL-CH-92102 103. \$	INVL-CH-92102 103. \$	INVL-CH-92102 103. \$	
Mounting assembly for rear mount scraper cylinder.	INVL-HYD-7480 351. \$	INVL-HYD-7480 351. \$	INVL-HYD-7480 351. \$	INVL-HYD-7480 351. \$	
Kit of 2 cylinders for rear mount scraper.	2 X 25TR04 322. \$	2 X 25TR04 322. \$	2 X 25TR04 322. \$	2 X 25TR04 322. \$	



PUMA AND INVERTED PUMA SNOWBLOWERS



CHOICE OF COLOR		RETAIL PRICE
	PUMA-48 to PUMA-80 PUMA-64-IV & PUMA-72-IV	PUMA-84 to PUMA-96 PUMA-74-IV & PUMA-80-IV
Blue	PG1-02	PG2-02
Orange	PG1-04	PG2-04
INDUSTRIAL yellow	PG1-06	PG2-06
Green	PG1-07	PG2-07
KIO orange	PG1-09	PG1-09
Black	PG1-10	PG2-10
	164. \$	188. \$
<i>N.B.: No cancellation for colors will be accepted.</i>		
CHARACTERISTICS AND OPTIONS ILLUSTRATED ON PAGE 14.		

FREIGHT CHARGES	F.O.B. St-Tite - Refer to the list of shipping costs.
------------------------	--------------------------------------------------------------

WARRANTY : One (1) year on manufacturing defects - void if product has been altered or misused.
 The PTO shaft warranty is given by the manufacturer and applies only to manufacturing defects.
 Prices and Specifications subject to change without notice. ALL TAXES EXTRA WHEN APPLICABLE.



PUMA SNOWBLOWERS



SPECIFICATIONS										
MODEL	PUMA-48	PUMA-54	PUMA-64	PUMA-72	PUMA-76	PUMA-80	PUMA-84	PUMA-94	PUMA-96	
HP recommended (HP PTO)	18 to 22	18 to 22	18 to 25	20 to 30	25 to 40	30 to 45	40 to 75	50 to 75	80 to 125	
Working width	in. mm 48" 1219	54" 1371	64" 1626	72" 1828	76" 1930	80" 2032	84" 2134	94" 2388	96" 2438	
Cutting height	in. mm 25" 635	28" 724	30" 762	32 1/2" 825	34" 864	38" 965				
Hitch category	1				1 & 2				2	
Drum diameter	in. mm 21" 533	24" 609			26" 660	28" 711		32" 813		
Depth of drum	in. mm 7" 178				8" 203		11" 279			
Drum wall	High quality steel									
Number of impeller blades	4								5	
Impeller shaft diameter	in. mm 1" 25	1 1/4" 32			1 9/16" 40			2" 51		
Height - impeller center	in. mm 12 3/4" 324	14" 355		16" 406	17" 432	18 1/2" 470		20 1/2" 521		
Impeller RPM	540 RPM									
Required RPM for the tractor PTO	540 RPM									
Accelerator (option)	PUACC-4854		PUACC-6472			-				
Number of augers	1									
Main auger diameter	in. mm 16" 406				17" 432		20" 508		23" 584	
Bearing / ductile iron casting	in. mm 1" 25				1 1/4" 32				1 1/2" 38	
Drive chain - main auger	50				60				80	
Number of shear bolts	1 for impeller + 1 for auger									
PTO	T20			T40			T50	T60	T80	
Scraper blade	High quality steel, welded									
	3/8" x 1 1/2"				3/8" x 2 1/2"		3/8" x 3"		1/2" x 4"	
Adjustable skid shoes	High quality steel									
Chute	CPUSI-4872			CPUSI-7480			CPUSI-8496			
Chute rotation	Manual	MD-4872			MD-74			MD-8494		
	Hydraulic cylinder	HRD-4872 • 25TR04			HRD-74 • 25TR08			HRD-8494 • 25TR08		
	Hydraulic motor	HMD-4872 • MLH-125			HMD-74 • MLH-250-R			HMD-8494 • MLH-315-R		
	Electric motor	ERD-4872			-			-		
Chute rotation maximum angle	Manual rotation	255°			280°			-		
	Hyd. cylinder rotation	240°			250°			-		
	Hyd. motor rotation	250°			280°			-		
	Electric rotation	255°			-			-		
Antifriction for chute	Ring									
Deflector	Manual									
- Hydraulic cylinder option	25TR04					25TR08				
- Electric actuator option	AE-04				-					
Color ¹	Prnovost red									
Storage support	✓									
Weight including chute	lbs kg 366 166	385 175	435 197	462 210	716 325	730 331	955 433	980 445	1300 590	

¹ Choice of color available in option.

Design and specifications subject to change without notice.



INVERTED PUMA SNOWBLOWERS



SPECIFICATIONS					
MODEL		PUMA-64-IV	PUMA-72-IV	PUMA-74-IV	PUMA-80-IV
HP recommended (HP PTO)		18 to 30		30 to 50	
Working width	in. mm	64" 1626	72" 1828	74" 1879	80" 2032
Cutting height	in. mm	29" 737		31" 787	
Hitch category		1			
Drum diameter	in. mm	24" 609		26" 660	
Depth of drum	in. mm	7" 178		9" 228	
Drum wall		High quality steel			
Number of impeller blades		4			
Impeller shaft diameter	in. mm	1 1/4" 32		1 9/16" 40	
Height - impeller center	in. mm	15" 381		16" 406	
Impeller RPM		540 RPM			
Required RPM for the tractor PTO		540 RPM			
Number of augers		1			
Main auger diameter	in. mm	16" 406		17" 432	
Bearing / ductile iron casting	in. mm	1" 25		1 1/2" 38	
Drive chain - main auger		50		60	
Number of shear bolts		1 for impeller + 1 for auger			
Inverted PTO		T40		T50	
Scraper blade		High quality steel 3/8" x 1 1/2" welded			
Adjustable skid shoes		High quality steel			
Chute		CPUSI-4872-IV		CPUSI-7480-IV	
Chute rotation	Hydraulic motor	MLH-125		MLH-250-R	
	Electric motor	ERD-4872		-	
Chute rotation max. angle	Hydraulic motor rotation	250°		335°	
	Electric rotation	255°		-	
Antifriction for chute		Ring			
Deflector		Telescopic rod			
- Hydraulic cylinder option		25TR04			
- Electric actuator option		AE-04		-	
Color ¹		Pronovost red			
Weight including chute	lbs kg	470 213	502 228	705 320	740 336

¹ Choice of color available in option.

Design and specifications subject to change without notice.

CHARACTERISTICS AND OPTIONS - PRIVATE USERS CATEGORY

CHUTE



CPUSI-4872 (-IV)
CPUSI-7480 (-IV)
CPUSI-8496

- ✓ Puma Series
- ✓ Inverted Puma Series

CHUTE DEFLECTOR

MANUAL DEFLECTOR



- ✓ Puma Series
- ✓ Lynx Series

CYLINDER DEFLECTOR



- ✓ Puma Series
- ✓ Lynx Series

ELECTRIC DEFLECTOR



- ✓ Puma Series
- ✓ Lynx Series

ACCELERATOR



- ✓ Puma Series

CHUTE ROTATION

MANUAL ROTATION



- ✓ Puma Series



- ✓ Lynx Series

HYDRAULIC MOTOR ROTATION



- ✓ Puma Series

HYDRAULIC CYLINDER ROTATION



- ✓ Puma Series



- ✓ Lynx Series

ELECTRIC ROTATION



- ✓ Puma Series
- ✓ Lynx Series

CONTRACTORS CATEGORY



PRONOVOST SNOWBLOWERS - GROUP I



HP recommended : 18 to 65 HP PTO

INCLUDED IN COMBO PRICE

- ✓ Semi-industrial chute
 - PSIG-5472 (for P-540 to P-720(TRC)-80).
 - PC3C-GR1.5 (for P-82126(TRC)-HP).
- ✓ Hydraulic cylinder and hose support for deflector adjustment.
- ✓ Chute rotation kit for hydraulic motor (motor included).
- ✓ Standard PTO.
- ✓ High quality steel scraper blade, not reversible (reversible for the P-82126(TRC)-HP only).
- ✓ Quick adjust skid shoes, high quality steel.
- ✓ Hydraulic motor for rotary drum rotation on TRC models (with rotary drum).
- ✓ Hardox 450 drum wall on the P-82126(TRC)-HP.
- ✓ Sealed chain guard on auger drive of P-82126(TRC)-HP.
- ✓ Pronovost red color.

SUGGESTED RETAIL

HP	MODEL	COMBO RETAIL PRICE
18 to 25	P-540	8,341. \$
20 to 30	P-620	8,419. \$
25 to 40	P-680	9,658. \$
25 to 40	P-720	9,753. \$
35 to 45	P-720-74	10,138. \$
35 to 45	P-720-80	10,204. \$
45 to 65	P-82126-HP	11,248. \$

HP	WITH ROTARY DRUM	COMBO RETAIL PRICE
25 to 40	P-720TRC	11,333. \$
35 to 45	P-720TRC-74	11,763. \$
35 to 45	P-720TRC-80	12,324. \$
45 to 65	P-82126TRC-HP	12,871. \$

CHOICE OF CHUTE		SURCHARGE PRICE	RETAIL PRICE
P-540 to P-720(TRC)-80			
PSIG-5472	Semi-industrial chute with greasable hinges and access panel (removable).	Included in combo	963. \$
PC3C-GR1	Semi-industrial chute with 3 deflectors, greasable hinges and access panel (removable).	Surcharge on combo price 236.¹ \$	1,199. \$
P-82126(TRC)-HP			
PC3C-GR1.5	Semi-industrial chute with 3 deflectors, greasable hinges and access panel (removable).	Included in combo	1,354. \$
PCG3C-GR1.5	Quick attach industrial chute with greasable hinges and access panel (removable).	Surcharge on combo price 946.¹ \$	2,300. \$
PRP-GR1.5	48" extension for industrial chute. *PKB available, price on demand.		949. \$
ADJUSTMENT FOR CHUTE DEFLECTOR			RETAIL PRICE
T-4864	Manual telescopic rod. <i>This telescopic rod replaces the 25TR04 cylinder and the TSB-4864 hose support.</i>		96. \$



PRONOVOST SNOWBLOWERS - GROUP I



HOSE KIT		RETAIL PRICE
FOR BASIC FUNCTIONS		
P-540 to P-82126-HP	PKB-GR1	423. \$
P-720TRC to P-82126TRC-HP	PKB-GR1TRC	660. \$
Includes hydraulic hoses connecting the tractor oil outlets to the deflector adjustment cylinder , the chute rotation motor and the drum rotation motor (TRC models only). * Installation not included.		

SKID SHOES		SURCHARGE PRICE
PHD-4872	Industrial skid shoes with carbon steel soles. ^{1,2}	100.¹ \$
PST-4872	Skid shoes with stainless steel soles. ^{1,2}	199.¹ \$

SCRAPER BLADE		SURCHARGE PRICE			
	Semi-industrial, Hardox 450, not reversible 1/2" x 3" not sharpened. ^{1,2}	TIVAR, 1" thick, not reversible, including mounting kit. ^{1,2}	Stainless steel, not reversible, 1/2" x 3" not sharpened. ^{1,2,3}		
P-540	SIT1-54 171.¹ \$	TV-54 589.¹ \$	SST-54 297.¹ \$		
P-620	SIT1-62 176.¹ \$	TV-62 589.¹ \$	SST-62 303.¹ \$		
P-680	SIT1-68 179.¹ \$	TV-68 589.¹ \$	SST-68 311.¹ \$		
P-720(TRC)	SIT1-72 189.¹ \$	TV-72 589.¹ \$	SST-72 323.¹ \$		
P-720(TRC)-74	SIT1-7274 217.¹ \$	TV-7274 589.¹ \$	SST-7274 341.¹ \$		
P-720(TRC)-80	SIT1-7280 219.¹ \$	TV-7280 589.¹ \$	SST-7280 357.¹ \$		
P-82126(TRC)-HP	SIT1-182* 219.¹ \$	TV-182 589.¹ \$	SST-182* 357.¹ \$		
	*1/2" x 3 1/2", reversible			*1/2" x 3 1/2", reversible	

LATERAL BLADES		RETAIL PRICE
CL-4872	Set of 2 lateral blades, high quality steel. ⁴ 3/8" x 2 1/2" x 39 1/2"	262. \$

SPEED REDUCER		RETAIL PRICE
IMPORTANT: When ordering a speed reducer, select the required PTO shaft below.		
P-680 to P-82126(TRC)-HP		
PR-7502-1	Inverter 540/540 RPM (1:1) - 75 HP at 540 RPM - 2 gears - shafts 4.855" c/c.	2,544. \$
PR-7502-2	Speed reducer inverter 1000/555 RPM (1.8:1) - 85 HP at 1000 RPM - 2 gears - shafts 4.855" c/c.	2,544. \$
PRC-6501-1	Non-inverting PTO drop box 540/540 RPM (1:1) - 55 HP at 540 RPM - chain - shafts 6.5" c/c.	1,366. \$

CHOICE OF PTO		SURCHARGE PRICE	RETAIL PRICE
P-720(TRC) to P-82126(TRC)-HP			
8114	T50 PTO 1 3/8" - 6 & 1 3/8"-6 (540 RPM)	Included in combo	485. \$
8202	T60 PTO 1 3/8"-6 & 1 3/8"-6 (540 RPM)	56.¹ \$	541. \$
8202-1	T60 PTO 1 3/8"-21 & 1 3/8"-6 (1000 RPM)	127.¹ \$	612. \$

ACCELERATOR		RETAIL PRICE
P-540 and P-620	PACC-5462 Accelerator 540/756 (1:1.4) (45 HP).	1,614. \$



RUBBER DEFLECTOR FLAP		RETAIL PRICE
TL-5480	Located from the top of the frame to the auger. Reduces projections.	235. \$
CHOICE OF COLOR		RETAIL PRICE
PG1-02	Blue	164. \$
PG1-04	Orange	164. \$
PG1-06	INDUSTRIAL yellow	164. \$
PG1-07	Green	164. \$
PG1-09	KIO orange	164. \$
PG1-10	Black	164. \$
<i>N.B.: No cancellation for colors will be accepted.</i>		
CHARACTERISTICS AND OPTIONS ILLUSTRATED ON PAGES 44 TO 46.		

¹ Surcharge for option in replacement of the regular component or on the combo price. See combos page 82.

² **Cutting edge and skid shoe wear - not warranted.**

³ Steel bolts included. Stainless steel bolts can be ordered from our parts department.

⁴ Increase the width by 3/4".

FREIGHT CHARGES	F.O.B. St-Tite - Refer to the list of shipping costs.
------------------------	--------------------------------------------------------------

WARRANTY : One (1) year on manufacturing defects - void if product has been altered or misused.

The PTO shaft warranty is given by the manufacturer and applies only to manufacturing defects.

Prices and Specifications subject to change without notice. ALL TAXES EXTRA WHEN APPLICABLE.



SPECIFICATIONS								
MODEL		P-540	P-620	P-680	P-720	P-720-74	P-720-80	P-82126-HP
TRC MODEL (WITH ROTARY DRUM)		-	-	-	P-720 TRC	P-720 TRC-74	P-720 TRC-80	P-82126 TRC-HP
HP recommended (HP PTO)		18 - 25	20 - 30	25 - 40		35 - 45		45 - 65
Working width	in. mm	54" 1371	62" 1574	68" 1727	72" 1828	74" 1879	80" 2032	82" 2083
Cutting height	in. mm	28" 711	30" 762					
Cutting height with lateral blades (Opt. CL)	in. mm	39 1/2" 1003						
Hitch category		1						
Drum diameter	in. mm	22" 559	24" 609			26" 660		
Depth of drum	in. mm	9" 229		10 1/2" 267				12" 305
Drum wall		High quality steel						
Number of impeller blades		4						
Impeller shaft diameter	in. mm	1 1/4" 32			1 9/16" 40			
Height - impeller center	in. mm	14" 356	15" 381			16 1/2" 419		
Impeller RPM		540 RPM						
Required RPM for the tractor PTO		540 RPM		540 RPM • Opt. 1000 RPM				
Hydraulic motor for drum rotation (TRC models)		-			MLH-100			MLH-250
Number of augers		1						
Main auger diameter	in. mm	16" 406			19" 483			22" 559
Bearing / ductile iron casting	in. mm	1" 25			1 1/4" 32			
Drive chain - main auger		50			60			
Number of shear bolts		1 for impeller + 1 for auger						
Speed reducer & inverter (option)		-			Your choice : PRC-6501-1, PR-7502-1, PR-7502-2			
Accelerator (option)		PACC-5462			-			
Included PTO (optional)		T20		T40	T50 (T60)			
Optional lateral blades		High quality steel						
Scraper blade		3/8" x 2 1/2" not reversible						3/8" x 3 1/2" reversible
- Option semi-industrial, Hardox 450		SIT1-54	SIT1-62	SIT1-68	SIT1-72	SIT1-7274	SIT1-7280	SIT1-182
- Option Tivar		TV-54	TV-62	TV-68	TV-72	TV-7274	TV-7280	TV-182
- Option stainless steel		SST-54	SST-62	SST-68	SST-72	SST-7274	SST-7280	SST-182
Adjustable skid shoes	Quick adjust	High quality steel						
- Option Hardox 450		PHD-4872						
- Option stainless steel		PST-4872						
Chute	Semi-industrial	PSIG-5472						PC3C-GR1.5
Chute rotation	With hydraulic motor	MLH-125			MLH-250-R			
Chute rotation maximum angle	Hydraulic motor rotation	270° to 345° adjustable						
Antifriction for chute		Ring						
Chute deflector	Hydraulic cylinder	25TR04						
- Option manual		T-4864						
Color (including primer)		Pronovost Red ¹			Pronovost Red ¹			
Storage support		✓						
Weight including PSIG chute	lbs kg	643 292	649 290	863 391	883 401	945 429	975 442	1060 481
Weight TRC model including PSIG chute	lbs kg	-	-	-	1020 463	1085 492	1115 506	1195 542

¹ Choice of color available in option.

Design and specifications subject to change without notice.



HP recommended : 50 to 125 HP PTO



INCLUDED IN COMBO PRICE

- ✓ Semi-industrial chute with greasable hinges and access panel (removable).
- ✓ Hydraulic cylinder and hose support for deflector adjustment.
- ✓ Chute rotation kit for hydraulic motor (motor included).
- ✓ Standard PTO.
- ✓ High quality steel scraper blade, reversible.
- ✓ Quick adjust skid shoes, high quality steel.
- ✓ Hydraulic motor for rotary drum rotation on TRC models (with rotary drum).
- ✓ Pronovost red color.

SUGGESTED RETAIL

HP	MODEL	COMBO RETAIL PRICE	HP	WITH ROTARY DRUM	COMBO RETAIL PRICE
50 to 70	P-800	11,519. \$	50 to 70	P-800TRC	14,503. \$
50 to 80	P-860	12,003. \$	50 to 80	P-860TRC	14,987. \$
50 to 80	P-862	14,863. \$	50 to 80	P-862TRC	17,850. \$
50 to 80	P-860-92	12,306. \$	50 to 80	P-860TRC-92	15,292. \$
75 to 95	P-920	15,583. \$	75 to 95	P-920TRC	18,581. \$
75 to 95	P-920-98	15,979. \$	75 to 95	P-920TRC-98	18,978. \$
90 to 125	P-922	18,620. \$	90 to 125	P-922TRC	21,573. \$
90 to 125	P-922-98	19,080. \$	90 to 125	P-922TRC-98	22,032. \$
90 to 125	P-98134	16,699. \$	90 to 125	P-98134TRC	20,477. \$

OPTION	DESCRIPTION	SURCHARGE PRICE	RETAIL PRICE
CHOICE OF CHUTE			
PSIG-7486	Semi-industrial chute with greasable hinges and access panel (removable).	Included in combo	1,385. \$
PCG-7486	Quick attach industrial chute with greasable hinges and access panel (removable).	Surcharge on combo price 1,007.¹ \$	2,392. \$
PRP-7486-2	24" extension for industrial chute. * PKB available, price on demand.		1,226. \$
PRP-7486	48" extension for industrial chute. * PKB available, price on demand.		1,329. \$
PCT-7486-HDB	Hydraulic telescopic industrial chute with greasable hinges and access panel, including extension cylinders and hose support + hose support for deflector cylinder. <i>Includes replacement of chute base for telescopic chute.</i>	Surcharge on combo price 7,582.¹ \$	8,967. \$
WORKING LIGHTS FOR CHUTE			RETAIL PRICE
PKL-IND7486	Mounting kit for working light on telescopic chute PCT-7486-HDB.		505. \$

¹ Surcharge for option in replacement of the regular component or on the combo price. See combos page 82.



PRONOVOST SNOWBLOWERS - GROUP II



HOSE KIT			RETAIL PRICE	
	FOR BASIC FUNCTIONS		WITH TELESCOPIC CHUTE PCT-7486-HDB	
P-800 to P-860-92	PKB-GR2	437. \$	PKB-GR2-T	861. \$
P-800TRC to P-860TRC-92	PKB-GR2TRC	686. \$	PKB-GR2TRC-T	1,074. \$
P-920 to P-98134	PKB-GR3	459. \$	PKB-GR3-T	895. \$
P-920TRC	PKB-GR3TRC	737. \$	PKB-GR3TRC-T	1,149. \$
P-922TRC to P-98134TRC	PKB-GR2TRC-34	737. \$	PKB-GR2TRC-34-T	1,149. \$
Includes hydraulic hoses connecting the tractor oil outlets to the deflector adjustment cylinder , the chute rotation motor and the drum rotation motor (TRC models only).				
			...and the telescopic chute lift cylinders .	
* Installation not included.				

SCRAPER BLADE					SURCHARGE PRICE			
	Semi-industrial Hardox 450 reversible 1/2" x 4" not sharpened. ^{1,2}		Industrial Hardox 450, not reversible 1/2" x 6" sharpened. ^{1,2}		TIVAR, 1" thick, including mounting kit. ^{1,2}		Stainless steel, reversible, 1/2" x 4" not sharpened. ^{1,2,3}	
P-800(TRC)	SIT1-80	237.¹ \$	T1-80	380.¹ \$	TV-80	619.¹ \$	SST-80	375.¹ \$
P-860(TRC)	SIT1-86	241.¹ \$	T1-86	406.¹ \$	TV-86	619.¹ \$	SST-86	375.¹ \$
P-862(TRC)	SIT1-86	241.¹ \$	T1-86	406.¹ \$	TV-86	619.¹ \$	SST-86	375.¹ \$
P-860(TRC)-92	SIT1-8692	279.¹ \$	T1-8692	431.¹ \$	TV-8692	619.¹ \$	SST-8692	436.¹ \$
P-920(TRC)	SIT1-92	279.¹ \$	T1-92	431.¹ \$	TV-92	619.¹ \$	SST-92	436.¹ \$
P-920(TRC)-98	SIT1-98	283.¹ \$	T1-98	468.¹ \$	TV-98	619.¹ \$	SST-98	439.¹ \$
P-922(TRC)	SIT1-92	279.¹ \$	T1-92	431.¹ \$	TV-92	619.¹ \$	SST-92	436.¹ \$
P-922(TRC)-98	SIT1-98	283.¹ \$	T1-98	468.¹ \$	TV-98	619.¹ \$	SST-98	439.¹ \$
P-98134(TRC)	SIT1-98	283.¹ \$	T1-98	468.¹ \$	TV-98	619.¹ \$	SST-98	439.¹ \$

SKID SHOES				SURCHARGE PRICE	
	Industrial skid shoes with Hardox 450 soles. ^{1,2}		Industrial skid shoes with Hardox 600 soles. ^{1,2}		Skid shoes with stainless steel soles. ^{1,2}
P-800(TRC) to P-860(TRC)-92	PHD-7486	143.¹ \$	PSHD-7486	221.¹ \$	PST-7486 244.¹ \$
P-920(TRC) to P-98134(TRC)	PHD-92104	187.¹ \$	PSHD-92104	318.¹ \$	PST-92104 301.¹ \$

LATERAL BLADES ⁴			RETAIL PRICE
P-800(TRC), P-860(TRC) and P-860(TRC)-92	CL-7486	High quality steel, 3/8" x 4" x 53 1/2".	408. \$
P-862(TRC), P-922(TRC) and P-922(TRC)-98	CL-8292	High quality steel, 3/8" x 4" x 62".	428. \$
P-920(TRC), P-920(TRC)-98 and P-98134(TRC)	CL-920	High quality steel, 3/8" x 4" x 61 1/2".	428. \$

¹ Surcharge for option in replacement of the regular component or on the combo price. See combos page 82.

² **Cutting edge and skid shoe wear - not warranted.**

³ Steel bolts included. Stainless steel bolts can be ordered from our parts department.

⁴ Increase the width by 3/4".



SPEED REDUCER		RETAIL PRICE	
IMPORTANT: When ordering a speed reducer, select the required PTO shaft below.			
P-800(TRC) to P-860(TRC)-92			
PR-7502-1	Inverter 540/540 RPM (1:1) - 75 HP at 540 RPM - 2 gears - shafts 4.855" c/c.	2,544. \$	
PR-7502-2	Speed reducer inverter 1000/555 RPM (1.8:1) - 85 HP at 1000 RPM - 2 gears - shafts 4.855" c/c.	2,544. \$	
PRH-25M-1	Drop box 1000/540 RPM. Two choices of input shafts : Reducer inverter 225 HP at 1000 RPM 2/3 gears - shafts 6 3/4" c/c or reducer only 175 HP at 1000 RPM 3/3 gears - shafts 8" c/c.	3,833. \$	
P-920(TRC) to P-98134(TRC)			
PRH-30M-2	Speed reducer 1000/555 RPM - 220 HP at 1000 RPM - 3 gears - shafts 7 1/16" c/c.	3,901. \$	
PRH-25M-2	Drop box 1000/540 RPM. Two choices of input shafts : Reducer inverter 225 HP at 1000 RPM 2/3 gears - shafts 6 3/4" c/c or reducer only 175 HP at 1000 RPM 3/3 gears - shafts 8" c/c.	4,074. \$	
IMPORTANT : When using a 1000/540 speed reducer, make sure to use a 10 mm shear bolt or a 12 mm shear bolt reduced to 3/8" according to model of drive shaft (PTO).			
CHOICE OF PTO		SURCHARGE PRICE	RETAIL PRICE
P-800(TRC)			
8114	T50 PTO 1 3/8"-6 & 1 3/8"-6 (540 RPM)	Included in combo	485. \$
8202	T60 PTO 1 3/8"-6 & 1 3/8"-6 (540 RPM)	56.¹ \$	541. \$
8202-1	T60 PTO 1 3/8"-21 & 1 3/8"-6 (1000 RPM)	127.¹ \$	612. \$
P-860(TRC) to P-860(TRC)-92			
8202	T60 PTO 1 3/8"-6 & 1 3/8"-6 (540 RPM)	Included in combo	541. \$
8202-1	T60 PTO 1 3/8"-21 & 1 3/8"-6 (1000 RPM)	71.¹ \$	612. \$
8202-V	V60 Multilobe PTO 1 3/8"-6 & 1 3/8"-6 (540 RPM)	481.¹ \$	1,022. \$
9225-1	T80 PTO 1 3/8"-6 & 1 3/8"-6 (540 RPM)	243.¹ \$	784. \$
9569	T80 PTO 1 3/8"-21 & 1 3/4"-20 (1000 RPM)	511.¹ \$	1,052. \$
9569-1	T80 PTO 1 3/4"-20 & 1 3/4"-20 (1000 RPM)	620.¹ \$	1,161. \$
9225-1-V	V80 Multilobe PTO 1 3/8"-6 & 1 3/8"-6 (540 RPM)	713.¹ \$	1,254. \$
9569-V	V80 Multilobe PTO 1 3/8"-21 & 1 3/4"-20 (1000 RPM)	849.¹ \$	1,390. \$
P-920(TRC) to P-98134(TRC)			
9225	T80 PTO 1 3/8"-6 & 1 3/4"-20 (540 RPM)	Included in combo	784. \$
9569	T80 PTO 1 3/8"-21 & 1 3/4"-20 (1000 RPM)	268.¹ \$	1,052. \$
9569-1	T80 PTO 1 3/4"-20 & 1 3/4"-20 (1000 RPM)	377.¹ \$	1,161. \$
9225-V	V80 Multilobe PTO 1 3/8"-6 & 1 3/4"-20 (540 RPM)	488.¹ \$	1,272. \$
9569-V	V80 Multilobe PTO 1 3/8"-21 & 1 3/4"-20 (1000 RPM)	606.¹ \$	1,390. \$
9475	T90 PTO 1 3/8"-6 & 1 3/4"-20 (540 RPM)	513.¹ \$	1,297. \$
9475-1	T90 PTO 1 3/8"-21 & 1 3/4"-20 (1000 RPM)	601.¹ \$	1,385. \$
9475-2	T90 PTO 1 3/4"-20 & 1 3/4"-20 (1000 RPM)	601.¹ \$	1,385. \$
9598	V90 Multilobe PTO 1 3/8"-6 & 1 3/4"-20 (540 RPM)	855.¹ \$	1,639. \$
9599	V90 Multilobe PTO 1 3/8"-21 & 1 3/4"-20 (1000 RPM)	891.¹ \$	1,675. \$
9604	V90 Multilobe PTO 1 3/4"-20 & 1 3/4"-20 (1000 RPM)	891.¹ \$	1,675. \$

¹ Surcharge for option in replacement of the regular component or on the combo price. See combos page 82.



PRONOVOST SNOWBLOWERS - GROUP II



HARDOX 450 IMPELLER HOUSING CONTOUR¹		SURCHARGE PRICE
P-800	TBHD-2612	327. ¹ \$
P-800TRC	TBHD-2612TRC	327. ¹ \$
P-860, P-862 and P-860-92	TBHD-2812	327. ¹ \$
P-860TRC, P-862TRC and P-860TRC-92	TBHD-2812TRC	327. ¹ \$
P-920 and P-920-98	TBHD-3012	367. ¹ \$
P-920TRC and P-920TRC-98	TBHD-3012TRC	367. ¹ \$
P-922, P-922-98 and P-98134	TBHD-3412	367. ¹ \$
P-922TRC, P-922TRC-98 and P-98134TRC	TBHD-3412TRC	367. ¹ \$

N.B. : This option is available only when ordering snowblower, before manufacturing.
 N.B. : No cancellation for Hardox 450 impeller housing contour will be accepted.

FULL FLIGHT MAIN AUGER		SURCHARGE PRICE
	Full flight serrated auger. ¹	
P-800(TRC)	VIP-800	2,268. ¹ \$
P-860(TRC)	VIP-860	2,420. ¹ \$
P-862(TRC)	VIP-860	2,420. ¹ \$
P-860(TRC)-92	VIP-86092	2,421. ¹ \$
P-920(TRC)	VIP2-992	2,421. ¹ \$
P-920(TRC)-98	VIP2-920-98	2,421. ¹ \$
P-922(TRC)	VIP2-992	2,421. ¹ \$
P-922(TRC)-98	VIP2-920-98	2,421. ¹ \$
P-98134(TRC)	VIP2-920-98	2,421. ¹ \$

RUBBER DEFLECTOR FLAP		RETAIL PRICE
	Located from the top of the frame to the auger. Reduces projections.	
P-800(TRC)	TL-5480*	235. \$
P-860(TRC) to P-860(TRC)-92	TL-8092*	275. \$
P-920(TRC) to P-98134(TRC)	TL-9298*	283. \$
	* Not available for snowblowers with an upper auger.	

CHOICE OF COLOR		RETAIL PRICE
PG2-02	Blue	188. \$
PG2-04	Orange	188. \$
PG2-06	INDUSTRIAL yellow	188. \$
PG2-07	Green	188. \$
PG2-09	KIO orange	188. \$
PG2-10	Black	188. \$

N.B.: No cancellation for colors will be accepted.

CHARACTERISTICS AND OPTIONS ILLUSTRATED ON PAGES 44 TO 46.

¹ Surcharge for option in replacement of the regular component or on the combo price. See combos page 82.

FREIGHT CHARGES	F.O.B. St-Tite - Refer to the list of shipping costs.
------------------------	--------------------------------------------------------------

WARRANTY : One (1) year on manufacturing defects - void if product has been altered or misused.
 The PTO shaft warranty is given by the manufacturer and applies only to manufacturing defects.
 Prices and Specifications subject to change without notice. ALL TAXES EXTRA WHEN APPLICABLE.



PRONOVOST SNOWBLOWERS - GROUP II

CONTRACTORS CATEGORY



SPECIFICATIONS

MODEL		P-800	P-860	P-862	P-860-92
TRC MODEL (WITH ROTARY DRUM)		P-800TRC	P-860TRC	P-862TRC	P-860TRC-92
HP recommended (HP PTO)	min. - max.	50 - 70	50 - 80		
Working width	in. mm	80" 2032	86" 2184		92" 2336
Cutting height		34" 864	36" 914	42" 1067	36" 914
Cutting height - lateral blades (Opt. CL)	in. mm	53 1/2" 1359		62" 1575	53 1/2" 1359
Height with telescopic chute	in. mm	-	PCT-7486-HD: 108" 2743 closed, 140" 3556 extended		
Height with telescopic chute, TRC model	in. mm	-	PCT-7486-HD: 111" 2819 closed, 143" 3632 extended		
Hitch category		1 & 2			
Drum diameter	in. mm	26" 660	28" 711		
Depth of drum	in. mm	12" 305			
Drum wall		High quality steel			
- Option Hardox 450		TBHD-2612	TBHD-2812(TRC)		
Number of impeller blades		4			
Impeller shaft diameter	in. mm	1 9/16" 40			
Height - impeller center	in. mm	16 1/2" 419	17 1/2" 444		
Impeller RPM		540 RPM			
Required RPM for the tractor PTO		540 RPM Opt. 1000 RPM			
Number of auger		1	2	1	
Main auger diameter	in. mm	23" 584			
Upper auger	in. mm	-	14" 355	-	
Bearing / ductile iron casting	in. mm	1 1/4" 32			
Drive chain - main auger		80			
Number of shear bolts		1 for impeller + 1 for auger			
Hydraulic motor for drum rotation (TRC models)		MLH-250-R			
Inverter (option)		PR-7502-1			
Reducer inverter (option)		PR-7502-2			
Reducer (option)		PRH-25M-1			
Included PTO (optional)		T50 (T60)	T60 (T80 & V80)		
Lateral blades (option)		High quality steel			
Scraper blade		High quality steel			
- Option semi-industrial, Hardox 450		SIT1-80	SIT1-86	SIT1-8692	
- Option industrial, Hardox 450		T1-80	T1-86	T1-8692	
- Option Tivar		TV-80	TV-86	TV-8692	
- Option stainless steel		SST-80	SST-86	SST-8692	
Adjustable skid shoes	Quick adjust	High quality steel			
- Option Hardox 450		PHD-7486			
- Option Hardox 600		PSHD-7486			
- Option stainless steel		PST-7486			
Full flight main auger (industrial) (option)		VIP-800	VIP-860	VIP-860-92	
Chute	Semi-industrial	PSIG-7486			
- Option industrial quick attach		PCG-7486			
- Option extension 24" or 48"		PRP-7486(-2)			
- Option telescopic with lift cylinder		PCT-7486-HDB			
Chute rotation	With hydraulic motor	MLH-250-R			
Chute rotation angle : adjustable		270° to 335°			
Antifriction for chute		Ring			
Chute deflector	Hydraulic cylinder	25TR08			
- Option manual		T-74104			
Color (including primer)		Pronovot red ¹			
Storage support		✓			
Weight including PSIG chute	lbs kg	1268 577	1475 669	1514 734	1515 687
Weight TRC motor, including PSIG chute	lbs kg	1405 639	1645 746	1648 749	1685 764

¹ Choice of color available in option.

Design and specifications subject to change without notice.



PRONOVOST SNOWBLOWERS - GROUP II

CONTRACTORS CATEGORY



SPECIFICATIONS						
MODEL		P-920	P-920-98	P-922	P-922-98	P-98134
TRC MODEL (WITH ROTARY DRUM)		P-920TRC	P-920TRC-98	P-922TRC	P-922TRC-98	P-98134TRC
HP recommended (HP PTO)	min. - max.	75 - 95		90 - 125		
Working width	in. mm	92" 2336	98" 2489	92" 2336	98" 2489	98" 2489
Cutting height	in. mm	39" 991		44" 1118		40" 1016
Cutting height - lateral blades (Opt. CL)	in. mm	61 1/2" 1562		CL : 62" 1575		CL : 61 1/2" 1562
Height with telescopic chute	in. mm	PCT-7486-HD : 109" 2769 closed, 141" 3581 extended		PCT-7486-HD : 112" 2845 closed, 144" 3658 extended		
Height with telescopic chute, TRC model	in. mm	PCT-7486-HD : 114" 2896 closed, 145" 3683 extended		PCT-7486-HD : 117" 2972 closed, 149" 3785 extended		
Hitch category	in. mm	2 - 34 1/2" 876 c/c				
Drum diameter	in. mm	30" 762		34" 864		
Depth of drum	in. mm	12" 305				
Drum wall		High quality steel				
- Option Hardox 450		TBHD-3012(TRC)		TBHD-3412(TRC)		
Number of impeller blades		5		6		
Impeller shaft diameter	in. mm	2" 51				
Height - impeller center	in. mm	20" 508		21" 533		
Impeller RPM		540 RPM				
Required RPM for the tractor PTO		540 RPM Opt. 1000 RPM				
Number of auger		1		2		1
Main auger diameter	in. mm	23" 584				
Upper auger	in. mm	-		14" 355		-
Bearing / ductile iron casting	in. mm	1 1/2" 38				
Drive chain - main auger		80				
Number of shear bolts		1 for impeller + 1 for auger				
Hydraulic motor for drum rotation (TRC models)		MLH-315-R				
Reducer (option)		PRH-30M-2				
Reducer inverter (option)		PRH-25M-2				
Included PTO (optional)		T80 (V80, T90 & V90)				
Lateral blades (option)		High quality steel				
Scraper blade		High quality steel				
- Option semi-industrial, Hardox 450		SIT1-92	SIT1-98	SIT1-92		SIT1-98
- Option industrial, Hardox 450		T1-92	T1-98	T1-92		T1-98
- Option Tivar		TV-92	TV-98	TV-92		TV-98
- Option stainless steel		SST-92	SST-98	SST-92		SST-98
Adjustable skid shoes	Quick adjust	High quality steel				
- Option Hardox 450		PHD-92104				
- Option Hardox 600		PSHD-92104				
- Option stainless steel		PST-92104				
Full flight main auger (industrial) (option)		VIP2-992				
Chute	Semi-industrial	PSIG-7486				
- Option industrial quick attach		PCG-7486				
- Option extension 24" or 48"		PRP-7486(-2)				
- Option telescopic with lift cylinder		PCT-7486-HDB				
Chute rotation	With hydraulic motor	MLH-315-R				
Chute rotation angle : adjustable		270° to 335°				
Antifriction for chute		Ring				
Chute deflector	Hydraulic cylinder	25TR08				
- Option manual		T-74104				
Color (including primer)		Pronovost red ¹				
Storage support		✓				
Weight including PSIG chute	lbs kg	1945 884	1985 902	2240 1016	2300 1043	2095 950
Weight TRC model, including PSIG chute	lbs kg	2245 1020	2285 1038	2540 1152	2600 1179	2405 1091

¹ Choice of color available in option.

Design and specifications subject to change without notice.



PRONOVOST SNOWBLOWERS - GROUP III



Upper auger option illustrated.



HP recommended : 100 to 150 HP PTO

INCLUDED IN COMBO PRICE

- ✓ Semi-industrial chute with greasable hinges and access panel (removable).
- ✓ Hydraulic cylinder and hose support for deflector adjustment.
- ✓ Chute rotation kit for hydraulic motor (motor included).
- ✓ Standard PTO.
- ✓ High quality steel scraper blade, reversible.
- ✓ Quick adjust skid shoes, high quality steel.
- ✓ Hydraulic motor for rotary drum rotation on TRC models (with rotary drum).
- ✓ Pronovost red color.

NB.: Wider models can also be made on request and depending on the production schedule. Subject to conditions, please contact customer service for details.

SUGGESTED RETAIL (SINGLE AUGER*)

HP	MODEL	COMBO RETAIL PRICE	HP	WITH ROTARY DRUM	COMBO RETAIL PRICE
100 to 150	P-980	18,755. \$	100 to 150	P-980TRC	21,738. \$
100 to 150	P-1020	19,129. \$	100 to 150	P-1020TRC	22,110. \$
100 to 150	P-1040	19,290. \$	100 to 150	P-1040TRC	22,274. \$
100 to 150	P-1080	19,649. \$	100 to 150	P-1080TRC	22,632. \$

OPTION	DESCRIPTION	SURCHARGE PRICE	RETAIL PRICE
CHOICE OF CHUTE			
PSIG-92104	Semi-industrial chute with greasable hinges and removable access panel, including hose support for deflector cylinder.	Included in combo	2,006. \$
PCG-92104	Quick attach industrial chute with greasable hinges and removable access panel, including hose support for deflector cylinder.	Surcharge on combo price 2,012.¹ \$	4,018. \$
PRP-92104-2	24" extension for industrial chute. * PKB available, price on demand.		1,428. \$
PRP-92104	48" extension for industrial chute. * PKB available, price on demand.		1,629. \$
PCT-92104	Hydraulic telescopic industrial chute, a versatile chute for general use, with greasable hinges and access panel, including extension cylinders and hose support + hose support for deflector cylinder.	Surcharge on combo price 5,299.¹ \$	7,305. \$
PCTC-INDR	Hydraulic telescopic industrial chute with rounded deflector designed for truck loading, greasable hinges and access panel, including 2 extension cylinders and hose support and 2 deflector cylinders and hose support.	Surcharge on combo price 8,369.¹ \$	10,375. \$
WORKING LIGHTS FOR CHUTE			RETAIL PRICE
PKL-IND92104	Mounting kit for working light on telescopic chute PCT-92104.		505. \$
PKL-INDR	Mounting kit for working light on telescopic chute PCTC-INDR.		505. \$

¹ Surcharge for option in replacement of the regular component or on the combo price. See combos page 82.

* Add upper auger option as needed. See page 27.



PRONOVOST SNOWBLOWERS - GROUP III



HOSE KIT				RETAIL PRICE	
	FOR BASIC FUNCTIONS		WITH TELESCOPIC CHUTE PCT-92104		WITH TELESCOPIC CHUTE ROUND DEFLECTOR PCTC-INDR
P-980 to P-1080	PKB-GR3	459. \$	PKB-GR3-T	895. \$	PKB-GR3-TR 880. \$
P-980TRC to P-1080TRC	PKB-GR3TRC	737. \$	PKB-GR3TRC-T	1,149. \$	PKB-GR3TRC-TR 1,159. \$
	Includes hydraulic hoses connecting the tractor oil outlets to the deflector adjustment cylinder , the chute rotation motor and the drum rotation motor (TRC models only).		Includes hydraulic hoses connecting the tractor oil outlets to the deflector adjustment cylinder , the chute rotation motor , the drum rotation motor (TRC models only) and the telescopic chute lift cylinders .		Includes hydraulic hoses connecting the tractor oil outlets to the round deflector adjustment cylinder , the chute rotation motor , the drum rotation motor (TRC models only) and the telescopic chute lift cylinders .
	* Installation not included.				
SCRAPER BLADE				SURCHARGE PRICE	
	Semi-industrial, Hardox 450 reversible 1/2" x 4" not sharpened. ^{1,2}		Industrial, Hardox 450, not reversible 1/2" x 6" sharpened. ^{1,2}		Stainless steel, reversible, 1/2" x 4" not sharpened. ^{1,2,3}
P-980(TRC)	SIT1-98	283.¹ \$	T1-98	468.¹ \$	SST-98 439.¹ \$
P-1020(TRC)	SIT1-102	300.¹ \$	T1-102	494.¹ \$	SST-102 459.¹ \$
P-1040(TRC)	SIT1-104	300.¹ \$	T1-104	494.¹ \$	SST-104 459.¹ \$
P-1080(TRC)	SIT1-108	322.¹ \$	T1-108	534.¹ \$	SST-108 473.¹ \$
SKID SHOES				SURCHARGE PRICE	
PHD-92104	Industrial skid shoes, Hardox 450 soles. ^{1,2}				187.¹ \$
PSHD-92104	Industrial skid shoes, Hardox 600 soles. ^{1,2}				318.¹ \$
PST-92104	Skid shoes, stainless steel soles. ^{1,2}				301.¹ \$
LATERAL BLADES				RETAIL PRICE	
CL-98104	Lateral blades, high quality steel ⁴ 3/8" x 4" x 66" (98104).				463. \$
SPEED REDUCER				RETAIL PRICE	
IMPORTANT: When ordering a speed reducer, select the required PTO shaft below.					
PRH-30M-2	Speed reducer 1000/555 RPM - 220 HP at 1000 RPM - 3 gears - shafts 7 1/16" c/c.				3,901. \$
PRH-25M-2	Drop box 1000/540 RPM. Two choices of input shafts : Reducer inverter 225 HP at 1000 RPM 2/3 gears - shafts 6 3/4" c/c or reducer only (non-inverting) 175 HP at 1000 RPM 3/3 gears - shafts 8" c/c.				4,074. \$
PR3G200-2	Reducer 1000/555 (200 HP at 1000 RPM) 3 gears - 8" c/c.				6,083. \$
IMPORTANT : When using a 1000/540 speed reducer, be sure to use a 10 mm shear bolt or a 12 mm shear bolt reduced to 3/8" according to model of drive shaft (PTO).					

¹ Surcharge for option in replacement of the regular component or on the combo price. See combos page 82.

² **Cutting edge and skid shoe wear - not warranted.**

³ Steel bolts included. Stainless steel bolts can be ordered from our parts department.

⁴ Increase the width by 3/4".



PRONOVOST SNOWBLOWERS - GROUP III



CHOICE OF PTO		SURCHARGE PRICE	RETAIL PRICE	
P-980(TRC) to P-1080(TRC)				
9225	T80 PTO 1 3/8"-6 & 1 3/4"-20 (540 RPM)	Included in combo	784. \$	
9569	T80 PTO 1 3/8"-21 & 1 3/4"-20 (1000 RPM)	268.¹ \$	1,052. \$	
9569-1	T80 PTO 1 3/4"-20 & 1 3/4"-20 (1000 RPM)	377.¹ \$	1,161. \$	
9225-V	V80 Multilobe PTO 1 3/8"-6 & 1 3/4"-20 (540 RPM)	488.¹ \$	1,272. \$	
9569-V	V80 Multilobe PTO 1 3/8"-21 & 1 3/4"-20 (1000 RPM)	606.¹ \$	1,390. \$	
9475	T90 PTO 1 3/8"-6 & 1 3/4"-20 (540 RPM)	513.¹ \$	1,297. \$	
9475-1	T90 PTO 1 3/8"-21 & 1 3/4"-20 (1000 RPM)	601.¹ \$	1,385. \$	
9475-2	T90 PTO 1 3/4"-20 & 1 3/4"-20 (1000 RPM)	601.¹ \$	1,385. \$	
9598	V90 Multilobe PTO 1 3/8"-6 & 1 3/4"-20 (540 RPM)	855.¹ \$	1,639. \$	
9599	V90 Multilobe PTO 1 3/8"-21 & 1 3/4"-20 (1000 RPM)	891.¹ \$	1,675. \$	
9604	V90 Multilobe PTO 1 3/4"-20 & 1 3/4"-20 (1000 RPM)	891.¹ \$	1,675. \$	
AUGER	FULL FLIGHT MAIN AUGER	SURCHARGE PRICE	UPPER AUGER 14"	RETAIL PRICE
	Full flight serrated main auger. ¹		Upper auger 14". Including accessories.	
P-980(TRC)	VIP2-980	2,911.¹ \$	VS2-980	1,600. \$
P-1020(TRC)	VIP3-1020	3,080.¹ \$	VS3-1020	1,655. \$
P-1040(TRC)	VIP2-1040	3,080.¹ \$	VS2-1040	1,715. \$
P-1080(TRC)	VIP2-1080	3,110.¹ \$	VS2-1080	1,775. \$
RUBBER DEFLECTOR FLAP			RETAIL PRICE	
TL-98108*	Located from the top of the frame to the auger. Reduces projections.		288. \$	
* Not available for snowblowers with an upper auger.				
HARDOX 450 IMPELLER HOUSING CONTOUR ¹			SURCHARGE PRICE	
TBHD-3415	Impeller housing contour made of Hardox 450 for regular models.		455.¹ \$	
TBHD-3415TRC	Impeller housing contour made of Hardox 450 for TRC models.		455.¹ \$	
N.B. : Option available only when ordering snowblower before manufacturing. N.B. : No cancellation for Hardox 450 impeller housing contour will be accepted.				
CHOICE OF COLOR			RETAIL PRICE	
PG3-02	Blue		220. \$	
PG3-04	Orange		220. \$	
PG3-06	INDUSTRIAL yellow		220. \$	
PG3-07	Green		220. \$	
PG3-09	KIO orange		220. \$	
PG3-10	Black		220. \$	
N.B.: No cancellation for colors will be accepted.				
CHARACTERISTICS AND OPTIONS ILLUSTRATED ON PAGES 44 TO 46.				

¹ Surcharge for option in replacement of the regular component or on the combo price. See combos page 82.

FREIGHT CHARGES F.O.B. St-Tite - Refer to the list of shipping costs.

WARRANTY : One (1) year on manufacturing defects - void if product has been altered or misused.
The PTO shaft warranty is given by the manufacturer and applies only to manufacturing defects.
Prices and Specifications subject to change without notice. ALL TAXES EXTRA WHEN APPLICABLE.



SPECIFICATIONS					
MODEL		P-980	P-1020	P-1040	P-1080
TRC MODEL (WITH ROTARY DRUM)		P-980TRC	P-1020TRC	P-1040TRC	P-1080TRC
HP recommended (HP PTO)	min. - max.	100 - 150			
Working width	in. mm	98" 2489	102" 2591	104" 2641	108" 2743
Cutting height	in. mm	48" 1219			
Cutting height - lateral blades (Opt. CL)	in. mm	56 1/2" 1435			
Height with telescopic chute	in. mm	PCT-92104 : 116" 2946 closed, 147" 3734 extended PCTC-INDR : 120" 3048 closed, 152" 3861 extended			
Height with telescopic chute., TRC model	in. mm	PCT-92104 : 118" 2997 closed, 149" 3785 extended PCTC-INDR : 122" 3099 closed, 154" 3912 extended			
Hitch category	in. mm	2 - 34 1/2" 876 c/c			
Drum diameter	in. mm	34" 864			
Depth of drum	in. mm	15" 381			
Drum wall		High quality steel			
- Option Hardox 450		TBHD-3415(TRC)			
Number of impeller blades		6			
Impeller shaft diameter	in. mm	2" 51			
Height - impeller center	in. mm	21 1/2" 546			
Impeller RPM		540 RPM			
Required RPM for the tractor PTO		540 RPM Opt. 1000 RPM			
Number of augers		1 opt. 2			
Main auger diameter	in. mm	26" 660			
Upper auger 14" (option)	in. mm	VS2-980	VS3-1020	VS2-1040	VS2-1080
Bearing / ductile iron casting	in. mm	1 1/2" 38			
Drive chain - main auger		100			
Number of shear bolts		1 for impeller + 1 for auger			
Hydraulic motor for drum rotation (TRC models)		MLH-315-R			
Reducer (option)		PRH-30M-2 or PRH-25M-2			
Included PTO (optional)		T80 (V80, T90 & V90)			
Lateral blades (option)		High quality steel			
Scraper blade		High quality steel			
- Option semi-industrial, Hardox 450		SIT1-98	SIT1-102	SIT1-104	SIT1-108
- Option industrial, Hardox 450		T1-98	T1-102	T1-104	T1-108
- Option stainless steel		SST-98	SST-102	SST-104	SST-108
Adjustable skid shoes	Quick adjust	High quality steel			
- Option Hardox 450		PHD-92104			
- Option Hardox 600		PSHD-92104			
- Option stainless steel		PST-92104			
Full flight main auger (industrial) (option)		VIP2-980	VIP3-1020	VIP2-1040	VIP2-1080
Chute	Semi-industrial	PSIG-92104			
- Option industrial, quick attach		PCG-92104			
- Option extension 24" or 48"		PRP-92104(-2)			
- Option telescopic		PCT-92104			
- Option telescopic round deflector		PCTC-INDR			
Chute rotation	With hydraulic motor	MLH-315-R			
Chute rotation max. angle	Hydraulic motor rotation	305°			
Antifriction for chute		Ring			
Chute deflector	Hydraulic cylinder	25TR08			
Color (including primer)		Pronovost red ¹			
Storage support		✓			
Poids including PSIG chute	lbs kg	2093 951	2485 1127	2113 961	2530 1148
Weight including PSIG chute, TRC models	lbs kg	2765 1254	2785 1263	2805 1272	2850 1293

¹ Choice of color available in option.

Design and specifications subject to change without notice.



CONTRACTORS CATEGORY
PRONOVOST DOUBLE RIBBON; LARGE OPEN FLIGHT AUGER SERIES



From the professionals category, the GV snowblowers can blow hardened or icy snow easily and increase tonnage performance with the same horse power.



HP recommended : 50 to 125 HP PTO

INCLUDED IN COMBO PRICE

- ✓ Semi-industrial chute
 - PC3C-GR1.5 with 3 deflectors, with greasable hinges and removable access panel (for P-82126(TRC)-GV).
 - PSIG-7486 with greasable hinges and removable access panel (for P-92130(TRC)-GV and P-98134(TRC)-GV).
- ✓ Hardox 450 impeller housing contour (for P-82126(TRC)-GV).
- ✓ Hydraulic cylinder and hose support for deflector adjustment.
- ✓ Chute rotation kit for hydraulic motor (motor included).
- ✓ Standard PTO.
- ✓ High quality steel scraper blade, reversible.
- ✓ Quick adjust skid shoes, high quality steel.
- ✓ Hydraulic motor for rotary drum rotation on TRC models (with rotary drum).
- ✓ Large diameter auger, double ribboned and serrated.
- ✓ Drive chain protected by sealed guard.
- ✓ Rubber deflector flap.
- ✓ Pronovost red color.

SUGGESTED RETAIL

HP	MODEL	COMBO RETAIL PRICE	HP	WITH ROTARY DRUM	COMBO RETAIL PRICE
50 to 70	P-82126-GV	13,838. \$	50 to 70	P-82126TRC-GV	15,230. \$
75 to 95	P-92130-GV	17,913. \$	75 to 95	P-92130TRC-GV	20,849. \$
90 to 125	P-98134-GV	19,059. \$	90 to 125	P-98134TRC-GV	22,088. \$

CHOICE OF CHUTE		SURCHARGE PRICE	RETAIL PRICE
P-82126(TRC)-GV			
PC3C-GR1.5	Semi-industrial chute with 3 deflectors, greasable hinges and access panel (removable).	Included in combo	1,354. \$
PCG3C-GR1.5	Quick attach industrial chute with greasable hinges and access panel (removable).	Surcharge on combo price 946.¹ \$	2,300. \$
PRP-GR1.5	48" extension for industrial chute. * PKB available, price on demand.		949. \$
P-92130(TRC)-GV and P-98134(TRC)-GV			
PSIG-7486	Semi-industrial chute with greasable hinges and access panel (removable).	Included in combo	1,385. \$
PCG-7486	Quick attach industrial chute with greasable hinges and access panel (removable).	Surcharge on combo price 1,007.¹ \$	2,392. \$
PRP-7486-2	24" extension for industrial chute. * PKB available, price on demand.		1,226. \$
PRP-7486	48" extension for industrial chute. * PKB available, price on demand.		1,329. \$
PCT-7486-HDB	Hydraulic telescopic industrial chute with greasable hinges and access panel, including extension cylinders and hose support + hose support for deflector cylinder. <i>Includes replacement of chute base for telescopic chute.</i>	Surcharge on combo price 7,582.¹ \$	8,967. \$
WORKING LIGHTS FOR CHUTE			RETAIL PRICE
PKL-IND7486	Mounting kit for working light on telescopic chute PCT-7486-HDB.		505. \$

¹ Surcharge for option in replacement of the regular component or on the combo price. See combos page 82.



PRONOVOST DOUBLE RIBBON; LARGE OPEN FLIGHT AUGER SERIES



HOSE KIT			RETAIL PRICE	
	FOR BASIC FUNCTIONS		WITH TELESCOPIC CHUTE PCT-7486-HDB	
P-82126-GV	PKB-GR1	423. \$	-	
P-82126TRC-GV	PKB-GR1TRC	660. \$	-	
P-92130-GV and P-98134-GV	PKB-GR3	459. \$	PKB-GR3-T	895. \$
P-92130TRC-GV	PKB-GR3TRC	737. \$	PKB-GR3TRC-T	1,149. \$
P-98134TRC-GV	PKB-GR2TRC-34	737. \$	PKB-GR2TRC-34-T	1,149. \$
Includes hydraulic hoses connecting the tractor oil outlets to the deflector adjustment cylinder , the chute rotation motor and the drum rotation motor (TRC models only).				
			... and the telescopic chute lift cylinders .	
* Installation not included.				

SCRAPER BLADE		SURCHARGE PRICE		
	P-82126(TRC)-GV	P-92130(TRC)-GV	P-98134(TRC)-GV	
Semi-industrial, Hardox 450, reversible 1/2" x 3 1/2" not sharpened. ^{1,2}	SIT1-182 219.¹ \$	-	-	
Semi-industrial, Hardox 450, reversible 1/2" x 4" not sharpened. ^{1,2}	-	SIT1-92 279.¹ \$	SIT1-98 283.¹ \$	
Industrial, Hardox 450, not reversible 1/2" x 6" sharpened. ^{1,2}	-	T1-92 431.¹ \$	T1-98 468.¹ \$	
TIVAR, 1" thick, mounting kit included. ^{1,2}	TV-182 589.¹ \$	TV-92 619.¹ \$	TV-98 619.¹ \$	
Stainless steel, reversible, 1/2" x 3 1/2" not sharpened. ^{1,2,3}	SST-182 357.¹ \$	-	-	
Stainless steel, reversible, 1/2" x 4" not sharpened. ^{1,2,3}	-	SST-92 436.¹ \$	SST-98 439.¹ \$	

SKID SHOES		SURCHARGE PRICE			
	Industrial skid shoes, Hardox 450 soles. ^{1,2}	Industrial skid shoes, Hardox 600 soles. ^{1,2}	Skid shoes, stainless steel soles. ^{1,2}		
P-82126(TRC)-GV	PHD-4872 100.¹ \$	-	PST-4872	199.¹ \$	
P-92130(TRC)-GV and P-98134(TRC)-GV	PHD-92104 187.¹ \$	PSHD-92104 318.¹ \$	PST-92104	301.¹ \$	

HARDOX 450 IMPELLER HOUSING CONTOUR ¹		SURCHARGE PRICE	
P-82126-GV	TBHD-2612	Included	
P-82126TRC-GV	TBHD-2612TRC	Included	
P-92130-GV	TBHD-3012	367.¹ \$	
P-92130TRC-GV	TBHD-3012TRC	367.¹ \$	
P-98134-GV	TBHD-3412	367.¹ \$	
P-98134TRC-GV	TBHD-3412TRC	367.¹ \$	

N.B. : Option available only when ordering snowblower before manufacturing.
 N.B. : No cancellation for Hardox 450 impeller housing contour will be accepted.

CHARACTERISTICS AND OPTIONS ILLUSTRATED ON PAGES 44 TO 46.

¹ Surcharge for option in replacement of the regular component or on the combo price. See combos page 82.
² **Cutting edge and skid shoe wear - not warranted.**
³ Steel bolts included. Stainless steel bolts can be ordered from our parts department.



PRONOVOST DOUBLE RIBBON; LARGE OPEN FLIGHT AUGER SERIES



SPEED REDUCER **RETAIL PRICE**

IMPORTANT: When ordering a speed reducer, select the required PTO shaft below.

P-82126(TRC)-GV

PR-7502-1	Inverter 540/540 RPM (1:1) - 75 HP at 540 RPM - 2 gears - shafts 4.855" c/c.	2,544. \$
PR-7502-2	Speed reducer inverter 1000/555 RPM (1.8:1) - 85 HP at 1000 RPM - 2 gears - shafts 4.855" c/c.	2,544. \$
PRC-6501-1	Non-inverting PTO drop box 540/540 RPM (1:1) - 55 HP at 540 RPM - chain - shafts 6.5" c/c.	1,366. \$

P-92130(TRC)-GV and P-98134(TRC)-GV

PRH-30M-2	Speed reducer 1000/555 RPM - 220 HP at 1000 RPM - 3 gears - shafts 7 1/16" c/c.	3,901. \$
PRH-25M-2	Drop box 1000/540 RPM. Two choices of input shafts : Reducer inverter 225 HP at 1000 RPM 2/3 gears - shafts 6 3/4" c/c or reducer only (non-inverting) 175 HP at 1000 RPM 3/3 gears - shafts 8" c/c.	4,074. \$

IMPORTANT : When using a 1000/540 speed reducer, make sure to use a 10 mm shear bolt or a 12 mm shear bolt reduced to 3/8" according to model of drive shaft (PTO).

CHOICE OF PTO **SURCHARGE PRICE** **RETAIL PRICE**

P-82126(TRC)-GV

8114	T50 PTO 1 3/8" - 6 & 1 3/8"-6 (540 RPM)	Included in combo	485. \$
8202	T60 PTO 1 3/8"-6 & 1 3/8"-6 (540 RPM)	56.¹ \$	541. \$
8202-1	T60 PTO 1 3/8"-21 & 1 3/8"-6 (1000 RPM)	127.¹ \$	612. \$

P-92130(TRC)-GV and P-98134(TRC)-GV

9225	T80 PTO 1 3/8"-6 & 1 3/4"-20 (540 RPM)	Included in combo	784. \$
9569	T80 PTO 1 3/8"-21 & 1 3/4"-20 (1000 RPM)	268.¹ \$	1,052. \$
9569-1	T80 PTO 1 3/4"-20 & 1 3/4"-20 (1000 RPM)	377.¹ \$	1,161. \$
9225-V	V80 Multilobe PTO 1 3/8"-6 & 1 3/4"-20 (540 RPM)	488.¹ \$	1,272. \$
9569-V	V80 Multilobe PTO 1 3/8"-21 & 1 3/4"-20 (1000 RPM)	606.¹ \$	1,390. \$
9475	T90 PTO 1 3/8"-6 & 1 3/4"-20 (540 RPM)	513.¹ \$	1,297. \$
9475-1	T90 PTO 1 3/8"-21 & 1 3/4"-20 (1000 RPM)	601.¹ \$	1,385. \$
9475-2	T90 PTO 1 3/4"-20 & 1 3/4"-20 (1000 RPM)	601.¹ \$	1,385. \$
9598	V90 Multilobe PTO 1 3/8"-6 & 1 3/4"-20 (540 RPM)	855.¹ \$	1,639. \$
9599	V90 Multilobe PTO 1 3/8"-21 & 1 3/4"-20 (1000 RPM)	891.¹ \$	1,675. \$
9604	V90 Multilobe PTO 1 3/4"-20 & 1 3/4"-20 (1000 RPM)	891.¹ \$	1,675. \$

CHOICE OF COLOR **RETAIL PRICE** **RETAIL PRICE**

P-82126(TRC)-GV

PG1-02	Blue	164. \$
PG1-04	Orange	164. \$
PG1-06	INDUSTRIAL yellow	164. \$
PG1-07	Green	164. \$
PG1-09	KIO orange	164. \$
PG1-10	Black	164. \$

P-92130(TRC)-GV and P-98134(TRC)-GV

PG2-02	Blue	188. \$
PG2-04	Orange	188. \$
PG2-06	INDUSTRIAL yellow	188. \$
PG2-07	Green	188. \$
PG2-09	KIO Orange	188. \$
PG2-10	Black	188. \$

N.B.: No cancellation for colors will be accepted.

¹ Surcharge for option in replacement of the regular component or on the combo price. See combos page 82.

FREIGHT CHARGES **F.O.B. St-Tite** - Refer to the list of shipping costs.

WARRANTY : One (1) year on manufacturing defects - void if product has been altered or misused.

The PTO shaft warranty is given by the manufacturer and applies only to manufacturing defects.

Prices and Specifications subject to change without notice. ALL TAXES EXTRA WHEN APPLICABLE.



SPECIFICATIONS				
MODEL		P-82126-GV	P-92130-GV	P-98134-GV
TRC MODEL (WITH ROTARY DRUM)		P-82126TRC-GV	P-92130TRC-GV	P-98134TRC-GV
HP recommended (HP PTO)	min. - max.	50 - 70	75 - 95	90 - 125
Working width	in. mm	82" 2083	92" 2336	98" 2489
Cutting height	in. mm	30" 762	42" 1066	44" 1118
Hitch category		1	2	
Drum diameter	in. mm	26" 660	30" 762	34" 864
Depth of drum	in. mm	12" 305		
Drum wall		Hardox 450	High quality steel	
- Option Hardox 450		Included	TBHD-3012(TRC)	TBHD-3412(TRC)
Number of impeller blades		4	5	6
Impeller shaft diameter	in. mm	1 9/16" 40	2" 51	
Height - impeller center	in. mm	16 1/2" 419	20" 508	21" 533
Impeller RPM		540 RPM		
Required RPM for the tractor PTO		540 RPM Opt. 1000 RPM		
Number of auger		1		
Main auger diameter	in. mm	25" 635 Double ribboned, serrated	32" 813 Double ribboned, serrated	
Bearing / ductile iron casting	in. mm	1 1/4" 32	1 1/2" 38	
Drive chain - main auger		60 protected by sealed guard, removable access	80 protected by sealed guard, removable access	
Number of shear bolts		1 for impeller and 1 for auger		
Hydraulic motor for drum rotation (TRC model)		MLH-250-R	MLH-315-R	
Reducer (option)		Choice : PRC-6501-1, PR-7502-1, PR-7502-2	PRH-30M-2 or PRH-25M-2	
Included PTO (optional)		T50 (T60)	T80 (V80, T90 & V90)	T80 (T90)
Lateral blades		43" 1092	54" 1372	55" 1397
Scraper blade		High quality steel		
- Option semi-industrial, Hardox 450		SIT1-182	SIT1-92	SIT1-98
- Option industrial, Hardox 450		-	T1-92	T1-98
- Option Tivar		TV-182	TV-92	TV-98
- Option stainless steel		SST-182	SST-92	SST-98
Adjustable skid shoes	Quick adjust	High quality steel		
- Option Hardox 450		PHD-4872	PHD-92104	
- Option Hardox 600		-	PSHD-92104	
- Option stainless steel		PST-4872	PST-92104	
Chute	Semi-industrial	PC3C-GR1.5	PSIG-7486	PSIG-7486
- Option industrial quick attach		-	PCG-7486	
- Option 24" or 48" extension		-	PRP-7486(-2)	
- Option telescopic with lift cylinders		-	PCT-7486-HDB	
Chute rotation	With hydraulic motor	MLH-250-R	MLH-315-R	
Chute rotation angle : ajustable		270° to 345°	270° to 335°	
Antifriction for chute		Ring		
Deflector	Hydraulic cylinder	25TR04	25TR08	
Color (including primer)		Pronovost Red ¹		
Storage support		✓		
Weight approx. (with std chute)	lbs kg	1270 577	2361 1073	2540 1152
Weight approx., TRC models (with std chute)	lbs kg	1380 627	2511 1141	2912 1321

¹ Choice of color available in option.

Design and specifications subject to change without notice.



PRONOVOST SNOWBLOWERS - PXPL / X-PRO



HP recommended : 40 to 125 HP PTO

INCLUDED IN COMBO PRICE

- ✓ Semi-industrial chute with greasable hinges and access panel (removable).
- ✓ Hydraulic cylinder and hose support for deflector adjustment.
- ✓ Chute rotation kit for hydraulic motor (motor included).
- ✓ Standard PTO.
- ✓ High quality steel scraper blade, on snowblower, reversible.
- ✓ Quick adjust skid shoes, high quality steel, on snowblower.
- ✓ High quality steel scraper blade, on X-PRO blade.
- ✓ High quality steel skid shoes, on X-PRO blade.
- ✓ Pronovost red color.

IMPORTANT : Check the weight of the snowblower on page 36 to ensure the chosen model is suitable for your tractor. See evolution of weight changes on page 79.

New cylinders for X-PRO blade = improved speed ! PXPL-80 & PXPL-92(98).

SUGGESTED RETAIL

HP	MODEL	COMBO RETAIL PRICE
40 to 55	PXPL-80	17,212. \$
50 to 75	PXPL-86	22,693. \$
50 to 75	PXPL-86-92	22,791. \$
75 to 125	PXPL-92	25,897. \$
75 to 125	PXPL-92-98	26,122. \$

SCRAPE OR BLOW SNOW WITH ONLY ONE EQUIPMENT, WORK MORE EFFICIENTLY !

For several years now, PRONOVOST has worked at the development of the X-PRO blade, in order to meet very particular needs. The evolution of the X-PRO has resulted in the best performing product of the industry. Very versatile, the X-PRO is effective, fast, and easy to use on a large surface or in tight spots.

CHOICE OF CHUTE		SURCHARGE PRICE	RETAIL PRICE
PXPL-80			
PSIG-5472	Semi-industrial chute with greasable hinges and access panel (removable).	Included in combo	963. \$
PC3C-GR1	Semi-industrial chute with 3 deflectors, greasable hinges and access panel (removable).	Surcharge on combo price 236.¹ \$	1,199. \$
PXPL-86 to PXPL-92-98			
PSIG-7486	Semi-industrial chute with greasable hinges and access panel (removable).	Included in combo	1,385. \$
HOSE KIT		RETAIL PRICE	
FOR BASIC FUNCTIONS			
PXPL-80	PKB-PXPL-80	656. \$	
PXPL-86 to PXPL-92-98	PKB-PXPL-8698	676. \$	
Includes hydraulic hoses connecting the tractor oil outlets to the deflector adjustment cylinder , the hydraulic system controlling the blade and the chute rotation motor . Installation not included.			

¹ Surcharge for option in replacement of the regular component or on the combo price. See combos page 82.



PRONOVOST SNOWBLOWERS - PXPL / X-PRO



SCRAPER BLADE FOR SNOWBLOWER					SURCHARGE PRICE	
	PXPL-80	PXPL-86	PXPL-86-92	PXPL-92	PXPL-92-98	
Semi-industrial scraper blade, Hardox 450, not reversible 1/2" x 3" not sharpened. ^{1,2}	SIT1-XP80 219.¹ \$	-	-	-	-	
Semi-industrial scraper blade, Hardox 450, reversible 1/2" x 4" not sharpened. ^{1,2}	-	SIT1-86 241.¹ \$	SIT1-8692 279.¹ \$	SIT1-92 279.¹ \$	SIT1-98 283.¹ \$	
Industrial scraper blade, Hardox 450, not reversible 1/2" x 6" sharpened. ^{1,2}	-	T1-86 406.¹ \$	T1-8692 431.¹ \$	T1-92 431.¹ \$	T1-98 468.¹ \$	
TIVAR scraper blade, 1" thick, including mounting kit. ^{1,2}	TV-XP80 589.¹ \$	TV-86 619.¹ \$	TV-8692 619.¹ \$	TV-92 619.¹ \$	TV-98 619.¹ \$	
Stainless steel scraper blade, not reversible, not sharpened 1/2" x 2 1/2". ^{1,2}	SST-XP80 406.¹ \$	-	-	-	-	
Stainless steel scraper blade, reversible, not sharpened 1/2" x 4". ^{1,2}	-	SST-86 375.¹ \$	SST-8692 436.¹ \$	SST-92 436.¹ \$	SST-98 439.¹ \$	

SKID SHOES FOR SNOWBLOWER						SURCHARGE PRICE	
	Industrial skid shoes with Hardox 450 soles. ^{1,2}		Industrial skid shoes with Hardox 600 soles. ^{1,2}		Skid shoes with stainless steel soles. ^{1,2}		
PXPL-80	PHD-4872	100.¹ \$	-		PST-4872	199.¹ \$	
PXPL-86	PHD-7486	143.¹ \$	PSHD-7486	221.¹ \$	PST-7486	244.¹ \$	
PXPL-86-92	PHD-7486	143.¹ \$	PSHD-7486	221.¹ \$	PST-7486	244.¹ \$	
PXPL-92	PHD-92104	187.¹ \$	PSHD-92104	318.¹ \$	PST-92104	301.¹ \$	
PXPL-92-98	PHD-92104	187.¹ \$	PSHD-92104	318.¹ \$	PST-92104	301.¹ \$	

HARDOX 450 IMPELLER HOUSING CONTOUR ¹			SURCHARGE PRICE	
PXPL-80	TBHD-2610.5		279.¹ \$	
PXPL-86, PXPL-86-92	TBHD-2812		327.¹ \$	
PXPL-92, PXPL-92-98	TBHD-3212		334.¹ \$	

N.B. : Option available only when ordering snowblower before manufacturing.
 N.B. : No cancellation for Hardox 450 impeller housing contour will be accepted.

SPEED REDUCER			RETAIL PRICE
IMPORTANT: When ordering a speed reducer, select the required PTO shaft below.			
PXPL-86 et PXPL-86-92			
PRH-25M-1	Drop box 1000/540 RPM. Two choices of input shafts : Reducer inverter 225 HP at 1000 RPM 2/3 gears - shafts 6 3/4" c/c or reducer only (non-inverting) 175 HP at 1000 RPM 3/3 gears - shafts 8" c/c.		3,833. \$
PXPL-92 et PXPL-92-98			
PRH-30M-2	Speed reducer 1000/555 RPM 220 HP at 1000 RPM - 3 gears - shafts 7 1/16" c/c.		3,901. \$
PRH-25M-2	Drop box 1000/540 RPM. Two choices of input shafts : Reducer inverter 225 HP at 1000 RPM 2/3 gears - shafts 6 3/4" c/c or reducer only (non-inverting) 175 HP at 1000 RPM 3/3 gears - shafts 8" c/c.		4,074. \$
IMPORTANT : When using a 1000/540 speed reducer, make sure to use a 10 mm shear bolt or a 12 mm shear bolt reduced to 3/8" according to model of drive shaft (PTO).			

¹ Surcharge for option in replacement of the regular component or on the combo price. See combos page 82.

² Cutting edge and skid shoe wear - not warranted.



PRONOVOST SNOWBLOWERS - PXPL / X-PRO



CHOICE OF PTO		SURCHARGE PRICE	RETAIL PRICE
PXPL-86 and PXPL-86-92			
8202	T60 PTO 1 3/8"-6 & 1 3/8"-6 (540 RPM)	Included in combo	541. S
8202-V	V60 Multilobe PTO 1 3/8"-6 & 1 3/8"-6 (540 RPM)	481.¹ S	1,022. S
9225-1	T80 PTO 1 3/8"-6 & 1 3/8"-6 (540 RPM)	243.¹ S	784. S
9569	T80 PTO 1 3/8"-21 & 1 3/4"-20 (1000 RPM)	511.¹ S	1,052. S
9569-1	T80 PTO 1 3/4"-20 & 1 3/4"-20 (1000 RPM)	620.¹ S	1,161. S
9225-1-V	V80 Multilobe PTO 1 3/8"-6 & 1 3/8"-6 (540 RPM)	713.¹ S	1,254. S
9569-V	V80 Multilobe PTO 1 3/8"-21 & 1 3/4"-20 (1000 RPM)	849.¹ S	1,390. S
PXPL-92 and PXPL-92-98			
9225	T80 PTO 1 3/8"-6 & 1 3/4"-20 (540 RPM)	Included in combo	784. S
9569	T80 PTO 1 3/8"-21 & 1 3/4"-20 (1000 RPM)	268.¹ S	1,052. S
9569-1	T80 PTO 1 3/4"-20 & 1 3/4"-20 (1000 RPM)	377.¹ S	1,161. S
9225-V	V80 Multilobe PTO 1 3/8"-6 & 1 3/4"-20 (540 RPM)	488.¹ S	1,272. S
9569-V	V80 Multilobe PTO 1 3/8"-21 & 1 3/4"-20 (1000 RPM)	606.¹ S	1,390. S
9475	T90 PTO 1 3/8"-6 & 1 3/4"-20 (540 RPM)	513.¹ S	1,297. S
9475-1	T90 PTO 1 3/8"-21 & 1 3/4"-20 (1000 RPM)	601.¹ S	1,385. S
9475-2	T90 PTO 1 3/4"-20 & 1 3/4"-20 (1000 RPM)	601.¹ S	1,385. S
9598	V90 Multilobe PTO 1 3/8"-6 & 1 3/4"-20 (540 RPM)	855.¹ S	1,639. S
9599	V90 Multilobe PTO 1 3/8"-21 & 1 3/4"-20 (1000 RPM)	891.¹ S	1,675. S
9604	V90 Multilobe PTO 1 3/4"-20 & 1 3/4"-20 (1000 RPM)	891.¹ S	1,675. S

OPTIONS FOR X-PRO BLADE			SURCHARGE PRICE			
	Hardox 450 scraper blade and skid shoes. ^{1,2}		TIVAR scraper blade and skid shoes. ^{1,2}		Stainless steel scraper blade and skid shoes. ^{1,2}	
PXPL-80	PXPLHD-80⁴	238.¹ S	PXPLTV-80	733.¹ S	PXPLST-80	357.¹ S
PXPL-86	PXPLHD-86	286.¹ S	PXPLTV-86	744.¹ S	PXPLST-86	449.¹ S
PXPL-86-92	PXPLHD-92	292.¹ S	PXPLTV-92	777.¹ S	PXPLST-92	475.¹ S
PXPL-92	PXPLHD-92	292.¹ S	PXPLTV-92	777.¹ S	PXPLST-92	475.¹ S
PXPL-92-98	PXPLHD-98	300.¹ S	PXPLTV-98	804.¹ S	PXPLST-98	492.¹ S

CHOICE OF COLOR		RETAIL PRICE
PX-02	Blue	245. S
PX-04	Orange	245. S
PX-06	INDUSTRIAL yellow	245. S
PX-07	Green	245. S
PX-09	KIO orange	245. S
PX-10	Black	245. S

N.B.: No cancellation for colors will be accepted.

CHARACTERISTICS AND OPTIONS ILLUSTRATED ON PAGES 44 TO 46.

¹ Surcharge for option in replacement of the regular component or on the combo price. See combos page 82.

² Cutting edge and skid shoe wear - not warranted.

FREIGHT CHARGES	F.O.B. St-Tite - Refer to the list of shipping costs.
------------------------	--------------------------------------------------------------

WARRANTY : One (1) year on manufacturing defects - void if product has been altered or misused. The PTO shaft warranty is given by the manufacturer and applies only to manufacturing defects. Prices and Specifications subject to change without notice. ALL TAXES EXTRA WHEN APPLICABLE.



PRONOVOST SNOWBLOWERS - PXPL / X-PRO



SPECIFICATIONS

MODEL		PXPL-80	PXPL-86	PXPL-86-92	PXPL-92	PXPL-92-98
HP recommended (HP PTO)	min. - max.	40 - 55	50 - 75		75 - 125	
Working width	in. mm	80" 2032	86" 2184	92" 2336		98" 2489
Working width - X-PRO blade	in. mm	82" 2083	87 5/8" 2226	93 5/8" 2378	93 3/4" 2378	99 3/4" 2534
Cutting height	in. mm	28" 711			34" 864	
Cutting height - X-PRO blade	in. mm	6" 152			8" 203	
Hitch category	in. mm	1	2		2 - 35" 889 c/c	
Drum diameter	in. mm	26" 660	28" 711		32" 813	
Depth of drum	in. mm	10 1/2" 267	12" 305			
Drum wall		High quality steel				
Number of impeller blades		4			5	
Impeller shaft diameter	in. mm	1 9/16" 40			2" 51	
Height - impeller center	in. mm	16 1/2" 419	16" 406		18 1/4" 464	
RPM du rotor		540 RPM				
Required RPM for the tractor PTO		540 RPM	540 RPM Opt. 1000 RPM			
Number of auger		1				
Main auger diameter	in. mm	16" 406	20" 508		23" 584	
Bearing # ductile iron casting	in. mm	1" 25	1 1/2" 38			
Drive chain - main auger		50	80			
Number of shear bolts		1 for impeller + 1 for auger				
Reducer (option)		-	PR-81054		PRH-30M-2	
Included PTO (optional)		T50	T60 (T80)		T80 (T90)	
Scraper blade		High quality steel				
- Option semi-industrial, Hardox 450		SIT1-XP80	SIT1-86	SIT1-8692	SIT1-92	SIT1-98
- Option industrial, Hardox 450		-	T1-86	T1-8692	T1-92	T1-98
- Option Tivar		TV-XP80	TV-86	TV-8692	TV-92	TV-98
- Option stainless steel		SST-XP80	SST-86	SST-8692	SST-92	SST-98
Adjustable skid shoes	Quick adjust	High quality steel				
- Option Hardox 450		PHD-4872	PHD-7486		PHD-92104	
- Option Hardox 600		-	PSHD-7486		PSHD-92104	
- Option stainless steel		PST-4872	PST-7486		PST-92104	
Scraper blade and skid shoes on X-PRO blade		High quality steel				
- Option Hardox 450		PXPLHD-80	PXPLHD-86	PXPLHD-92		PXPLHD-98
- Option Tivar		PXPLTV-80	PXPLTV-86	PXPLTV-92		PXPLTV-98
- Option stainless steel		PXPLST-80	PXPLST-86	PXPLST-92		PXPLST-98
Chute	Semi-industrial	PSIG-5472	PSIG-7486			
Chute rotation	With hydraulic motor	MLH-250-R			MLH-315-R	
Chute rotation angle : adjustable		270° to 335°				
Antifriction for chute		Ring				
Deflector	Hydraulic cylinder	25TR04	25TR08			
- Option manual		T-4864	T-74104			
Color (including primer)		Pronovost red ¹				
Storage support		✓				
Weight including PSIG chute	lbs kg	1220 553	1889 857	1943 881	2530 1148	2540 1152

¹ Choice of color available in option.

See evolution of weight changes on page 79.

Design and specifications subject to change without notice.



HP recommended : 40 to 100 HP PTO

INCLUDED IN COMBO PRICE

- ✓ Black semi-industrial chute with greasable hinges and access panel (removable).
 - ✓ Hydraulic cylinder and hose support for deflector adjustment.
 - ✓ Chute rotation kit for hydraulic motor (motor with cushion valve included).
 - ✓ PTO (T40 for C7224, T50 for C8026, T60 for C9228).
 - ✓ High quality steel scraper blade (not reversible for C8026, reversible for C7224 and C9228).
 - ✓ Hot dip galvanized snowblower.
- * Optional colors available on pre-season orders.

SUGGESTED RETAIL

HP	MODEL	COMBO RETAIL PRICE
25 à 40	C7224	11,377. \$
40 to 60	C8026	13,167. \$
75 to 100	C9228	15,438. \$

MANY BENEFITS !

- More efficient and faster snow removal.
- Galvanized finish (ask for our explanatory document).
- Better visibility and weight distribution.
- Leaves a minimum of snow in the street.

CHOICE OF CHUTE		SURCHARGE PRICE	RETAIL PRICE
C7224 and C8026			
PSIG-5472	Semi-industrial chute with greasable hinges and access panel (removable).	Included in combo	963. \$
PC3C-GR1	Semi-industrial chute with 3 deflectors, greasable hinges and access panel (removable).	Surcharge on combo price 236.¹ \$	1,199. \$
C9228			
PSIG-7486	Semi-industrial chute with greasable hinges and access panel (removable).	Included in combo	1,385. \$

HOSE KIT		RETAIL PRICE						
	FOR BASIC FUNCTIONS		FOR HYDRAULIC WINGS FUNCTIONS ACCORDING TO THE AMOUNT OF OIL OUTLETS OF YOUR TRACTOR :					
			4 oil outlets		3 oil outlets		2 oil outlets	
C7224	PKB-GR1	423. \$	PKB-CO-80-2	381. \$	PKB-CO-72-DV	1,018. \$	PKB-CO-72-DV2	1,715. \$
C8026	PKB-GR1	423. \$	PKB-CO-80-2	381. \$	PKB-CO-80-DV	1,227. \$	PKB-CO-80-DV2	2,036. \$
C9228	PKB-GR2	437. \$	PKB-CO-92-2	391. \$	PKB-CO-92-DV	1,246. \$	PKB-CO-92-DV2	2,050. \$
	Includes hydraulic hoses connecting the tractor oil outlets to the deflector adjustment cylinder and the chute rotation motor. * Installation not included.		IMPORTANT NOTE: The action of each hydraulic wing controlled separately is strongly recommended. Connecting both hydraulic wings with a "T" can lead to uncontrolled opening of a wing and cause breakage to nearby obstacles. * Installation not included.					
	PKBM-GR1&2	402. \$	PKBM-CO			131. \$		
	Assembly of the snowblower and installation of the hose kit for the chute, rotation and deflector.		Assembly of the hydraulic wings including hose kit. Note : Installation of the wiring harness and control switch not included if there is the oil divider option.					



SCRAPER BLADE		SURCHARGE PRICE	
C7224			
SIT1-C72	Scraper blade, Hardox 450, reversible, not sharpened 1/2" x 3 1/2". ^{1,2}	225.¹ \$	
SST-C72	Scraper blade, stainless steel, reversible, not sharpened 1/2" x 3 1/2". ^{1,2,3}	323.¹ \$	
TV-C72	Scraper blade, Tivar 3/4" x 3 1/2" x 71 3/4", reversible, not sharpened. ^{1,2}	485.¹ \$	
C8026			
INV-SIT1-80	Scraper blade, Hardox 450, not reversible, not sharpened 1/2" x 3". ^{1,2}	231.¹ \$	
INV-SST-80	Scraper blade, stainless steel, not reversible, not sharpened 1/2" x 3". ^{1,2,3}	357.¹ \$	
TV-C80	Scraper blade, Tivar, 3/4" x 3" x 78 1/2", not reversible, not sharpened. ^{1,2}	485.¹ \$	
C9228			
SIT1-C92	Scraper blade, Hardox 450, reversible, not sharpened 1/2" x 4". ^{1,2}	288.¹ \$	
SST-C92	Scraper blade, stainless steel, reversible, not sharpened 1/2" x 4". ^{1,2,3}	436.¹ \$	
TV-C92	Scraper blade, Tivar, 1" x 4" x 93", reversible, not sharpened. ^{1,2}	659.¹ \$	
FRAME SIDE SKID SHOES		RETAIL PRICE	
C7224 et C8026	TVP-C80	Skid shoes, Tivar, reversible, 1 1/4" thick x 16 1/2" long, kit of 2.	
C9228	TVP-C92	Skid shoes, Tivar, reversible, 1 1/4" thick x 15 3/4" long, kit of 2.	
C7224 et C8026		414. \$	
C9228		463. \$	
WINGS		RETAIL PRICE	
C7224			
CO-72F	Fixed, hot dip galvanized wings with floating skid shoes.	1,183. \$	
CO-72HYD	Hydraulic, hot dip galvanized wings with floating skid shoes (up to 8') and cylinder.*	1,890. \$	
C8026			
CO-80F	Fixed, hot dip galvanized wings with floating skid shoes.	1,028. \$	
CO-80F-P	Fixed, black color wings with floating skid shoes.	1,028. \$	
CO-80HYD	Hydraulic, hot dip galvanized wings with floating skid shoes (up to 8'-6") and cylinder.*	1,962. \$	
CO-80HYD-P	Hydraulic, black color wings with floating skid shoes (up to 8'-6") and cylinder.*	1,962. \$	
C9228			
CO-92F	Fixed, hot dip galvanized wings with floating skid shoes.	1,256. \$	
CO-92F-P	Fixed, black color wings with floating skid shoes.	1,256. \$	
CO-92HYD	Hydraulic, hot dip galvanized wings with floating skid shoes (up to 10') and cylinder.*	2,118. \$	
CO-92HYD-P	Hydraulic, black color wings with floating skid shoes (up to 10') and cylinder.*	2,118. \$	
*We strongly recommend to control each hydraulic wing separately.			
3 POINT HITCH KIT		SURCHARGE PRICE	RETAIL PRICE
PM5-C80	Lower attachment and top link 5" higher.	Surcharge on combo price 121.¹ \$	460. \$

¹ Surcharge for option in replacement of the regular component or on the combo price. See combos page 82.

² **Cutting edge and skid shoe wear - not warranted.**

³ Steel bolts included. Stainless steel bolts can be ordered from our parts department.



CHOICE OF COLOR - PRE-SEASON ORDER ONLY						
A credit is granted	C7224		C8026		C9228	
Blue	C72-02	(597. \$)	C80-02	(687. \$)	C92-02	(936. \$)
Orange	C72-04	(597. \$)	C80-04	(687. \$)	C92-04	(936. \$)
INDUSTRIAL yellow	C72-06	(597. \$)	C80-06	(687. \$)	C92-06	(936. \$)
Green	C72-07	(597. \$)	C80-07	(687. \$)	C92-07	(936. \$)
PRONOVOST red	C72-08	(597. \$)	C80-08	(687. \$)	C92-08	(936. \$)
KIO orange	C72-09	(597. \$)	C80-09	(687. \$)	C92-09	(936. \$)
Black	C72-10	(597. \$)	C80-10	(687. \$)	C92-10	(936. \$)
<i>N.B.: No cancellation for colors will be accepted.</i>						
CHARACTERISTICS AND OPTIONS ILLUSTRATED ON PAGES 44 TO 46.						

FREIGHT CHARGES	F.O.B. St-Tite - Refer to the list of shipping costs.
------------------------	--------------------------------------------------------------

WARRANTY : One (1) year on manufacturing defects - void if product has been altered or misused.
 The PTO shaft warranty is given by the manufacturer and applies only to manufacturing defects.
 Prices and Specifications subject to change without notice. ALL TAXES EXTRA WHEN APPLICABLE.



SPECIFICATIONS					
MODEL		C7224	C8026	C9228	
HP recommended (HP PTO)	min. - max.	25 - 40	40 - 60	75 - 100	
Working width	in. mm	72" 1829	80" 2032	92" 2337	
Working width hydraulic wings (opt.)	in. mm	Closed : 74" 1879 Opened : 95" 2413	Closed : 85" 2159 Opened : 110" 2794	Closed : 95" 2413 Opened : 120" 3048	
Cutting height	in. mm	24" 610	28" 711	23" 584	
Hitch category	in. mm	1 - 26 13/16" 681	1 - 28 1/2" 726	2 - 33" 838	
Drum diameter	in. mm	24" 610	26" 660	28" 711	
Depth of drum	in. mm	10 1/2" 267	10 1/2" 267	12" 305	
Drum wall		High quality steel			
Number of impeller blades		4			
Impeller shaft diameter	in. mm	1 9/16" 40			
Height - impeller center	in. mm	21" 533	23" 584	25 3/8" 645	
Impeller RPM		540 RPM			
Required RPM for the tractor PTO		540 RPM			
Number of augers		1			
Main auger diameter	in. mm	14" 356	16" 406		
Bearing / ductile iron casting	in. mm	1" 25	1 1/4" 32	1 1/2" 38	
Drive chain - Main auger		50H	60	80H	
Number of shear bolts		1 for impeller + 1 for auger			
PTO		T40	T50	T60	
<i>Option - Stationary wings with floating skid shoes</i>		CO-72F	CO-80F	CO-92F	
<i>Option - Hydraulic wings with floating skid shoes, incl. cyl.</i>		CO-72HYD	CO-80HYD	CO-92HYD	
Scraper blade		High quality steel reversible	High quality steel not reversible	High quality steel reversible	
- <i>Option semi-industrial, Hardox 450</i>		SIT1-72 - 71 3/4	INV-SIT1-80 - 78 1/2"	SIT1-C92 - 93"	
- <i>Option Tivar</i>		TV-C72 - 71 3/4	TV-C80 - 78 1/2"	TV-C92 - 93"	
- <i>Option stainless steel</i>		SST-72 - 71 3/4	INV-SST-80 - 78 1/2"	SST-C92 - 93"	
<i>Option Tivar skid shoes for snowblower</i>		TVP-C80		TVP-C92	
Chute	Semi-industrial	PSIG-5472		PSIG-7486	
Chute rotation	With hydraulic motor	MLH-250-R		MLH-315-R	
Chute rotation maximum angle	Hydraulic motor rotation	270° to 345° adjustable		270° to 335° adjustable	
Antifriction for chute		Ring			
Deflector	Hydraulic cylinder	25TR04		25TR08	
Color		Hot dip galvanized			
Weight approx. hydraulic wings and cylinder	lbs kg	171 78	220 100	227 103	
Weight including chute (without hydraulic wings)	lbs kg	987 449	1195 542	1720 780	

Design and specifications subject to change without notice.



PRONOVOST SNOWBLOWERS - INVERTED



MODELS WITH GEAR BOX MOUNTED AT THE FRONT OF THE SNOWBLOWER.



Model P-INV-92



HP recommended : 40 to 100 HP PTO

INCLUDED IN COMBO PRICE

- ✓ Semi-industrial chute with greasable hinges and access panel (removable).
- ✓ Hydraulic cylinder and hose support for deflector adjustment.
- ✓ Chute rotation kit for hydraulic motor (motor included).
- ✓ Standard PTO.
- ✓ High quality steel scraper blade, removable.
- ✓ Adjustable skid shoes, high quality steel, on P-INV-92 and P-INV-92-102.
- ✓ Pronovost red color.

Rear mount scraper blade option (P-INVL) illustrated.

SUGGESTED RETAIL

HP	MODEL	COMBO RETAIL PRICE
40 to 60	P-INV-74	11,781. \$
40 to 60	P-INV-80	11,946. \$
75 to 100	P-INV-92	15,462. \$
75 to 100	P-INV-92-102	16,062. \$

The draw behind P-INV snowblower blows snow while travelling forward. The gear box on P-INV is mounted at the front of the snowblower which allows backing up closer to obstacles to remove the snow and to reduce the load on the 3 point hitch.

HOSE KIT		RETAIL PRICE			
		FOR BASIC FUNCTIONS		FOR REAR MOUNT SCRAPER BLADE OPTION	
P-INV-74 and P-INV-80	PKB-INV-7480	526. \$	PKB-INVL-7480	232. \$	
P-INV-92 and P-INV-92-102	PKB-INV-92102	561. \$	PKB-INVL-92102	267. \$	
		Includes hydraulic hoses connecting the tractor oil outlets to the deflector adjustment cylinder and the chute rotation motor .		Includes hydraulic hoses connecting the tractor oil outlets to the "T" on the snowblower (the "T" hoses to the cylinder are included in the hydraulic scraper option).	
* Installation not included.					
		P-INV-74	P-INV-80	P-INV-92	P-INV-92-102
Hardox 450 scraper blade, not reversible, not sharpened 1/2" x 3". ^{1,2}	INV-SIT1-74	231. ¹ \$	INV-SIT1-80	-	-
Hardox 450 scraper blade, reversible, not sharpened 1/2" x 4". ^{1,2}	-	-	-	INV-SIT1-92	INV-SIT1-92-102
				284. ¹ \$	284. ¹ \$
TIVAR scraper blade, 1" thick, not reversible, not sharpened. ^{1,2}	INV-TV-74	534. ¹ \$	INV-TV-80	INV-TV-92	INV-TV-92-102
				583. ¹ \$	783. ¹ \$
Stainless steel scraper blade, not reversible, not sharpened 1/2" x 3". ^{1,2,3}	INV-SST-74	341. ¹ \$	INV-SST-80	-	-
Stainless steel scraper blade, reversible, not sharpened 1/2" x 4". ^{1,2,3}	-	-	-	INV-SST-92	INV-SST-92-102
				400. ¹ \$	471. ¹ \$

¹ Surcharge for option in replacement of the regular component or on the combo price. See combos page 82.

² **Cutting edge and skid shoe wear - not warranted.**

³ Steel bolts included. Stainless steel bolts can be ordered from our parts department.



PRONOVOST SNOWBLOWERS - INVERTED



SKID SHOES				SURCHARGE PRICE		
	Industrial skid shoes, Hardox 450 soles ^{1,2}	Industrial skid shoes, Hardox 600 soles ^{1,2}	Skid shoes, stainless steel soles ^{1,2}			
P-INV-74 & P-INV-80	PHD-4872	100.¹ \$	-	PST-4872	199.¹ \$	
P-INV-92 & P-INV-92-102	PHD-7486	143.¹ \$	PSHD-7486	221.¹ \$	PST-7486	244.¹ \$

CHOICE OF PTO		SURCHARGE PRICE	RETAIL PRICE
P-INV-92 et P-INV-92-102			
8202	T60 PTO 1 3/8"-6 & 1 3/8"-6 (540 RPM)	Included in combo	541. \$
8202-V	V60 Multilobe PTO 1 3/8"-6 & 1 3/8"-6 (540 RPM)	481.¹ \$	1,022. \$
9225-1	T80 PTO 1 3/8"-6 & 1 3/8"-6 (540 RPM)	243.¹ \$	784. \$

REAR MOUNT SCRAPER BLADE AND OPTIONS					RETAIL PRICE
	P-INV-74	P-INV-80	P-INV-92	P-INV-92-102	
Rear mount scraper (scraper blade not included).	P-INV2-74 676. \$ <small>Weight : 90 lbs / 41 kg</small>	P-INV2-80 676. \$ <small>Weight : 94 lbs / 43 kg</small>	P-INV2-92 739. \$ <small>Weight : 154 lbs / 70 kg</small>	P-INV2-92-102 887. \$ <small>Weight : 162 lbs / 73 kg</small>	
Mounting assembly for rear mount scraper cylinder (including hoses from cylinders to "T").	INV2-HYD-7480 351. \$	INV2-HYD-7480 351. \$	INV2-HYD-92102 351. \$	INV2-HYD-92102 351. \$	
Kit of 2 cylinders for rear mount scraper. (Previous option is required with this option.)	2 X 25TR04 322. \$	2 X 25TR04 322. \$	2 X 25TR04 322. \$	2 X 25TR04 322. \$	
Kit of chains for rear mount scraper.	INV2-CH-92102 103. \$	INV2-CH-92102 103. \$	INV2-CH-92102 103. \$	INV2-CH-92102 103. \$	
Standard steel plow blade for rear mount scraper. ²	INV2-ST-74 164. \$	INV2-ST-80 164. \$	INV2-ST-92 174. \$	INV2-ST-92-102 187. \$	
TIVAR plow blade for rear mount scraper. ²	INV2-TV-74 711. \$	INV2-TV-80 711. \$	INV2-TV-92 719. \$	INV2-TV-92-102 788. \$	
Stainless steel plow blade for rear mount scraper. ²	INV2-SST-74 544. \$	INV2-SST-80 544. \$	INV2-SST-92 622. \$	INV2-SST-92-102 670. \$	

CHOICE OF COLOR		RETAIL PRICE
PG2-02	Blue	188. \$
PG2-04	Orange	188. \$
PG2-06	INDUSTRIAL yellow	188. \$
PG2-07	Green	188. \$
PG2-09	KIO orange	188. \$
PG2-10	Black	188. \$

N.B.: No cancellation for colors will be accepted.

CHARACTERISTICS AND OPTIONS ILLUSTRATED ON PAGES 44 TO 46.

¹ Surcharge for option in replacement of the regular component or on the combo price. See combos page 82.

² **Cutting edge and skid shoe wear - not warranted.**

³ Steel bolts included. Stainless steel bolts can be ordered from our parts department.

FREIGHT CHARGES	F.O.B. St-Tite - Refer to the list of shipping costs.
------------------------	--------------------------------------------------------------

WARRANTY : One (1) year on manufacturing defects - void if product has been altered or misused. The PTO shaft warranty is given by the manufacturer and applies only to manufacturing defects. Prices and Specifications subject to change without notice. ALL TAXES EXTRA WHEN APPLICABLE.



SPECIFICATIONS					
MODEL		P-INV-74	P-INV-80	P-INV-92	P-INV-92-102
HP recommended (HP PTO)	min. - max.	40 - 60		75 - 100	
Working width	in. mm	74" 1880	80" 2032	92" 2337	102" 2591
Cutting height	in. mm	28" 711		34" 864	
Hitch category	in. mm	1 - 28 1/2" 724 c/c		2 - 34 1/4" 876 c/c	
Drum diameter	in. mm	26" 660		30" 762	
Depth of drum	in. mm	10 1/2" 267		12" 305	
Drum wall		High quality steel			
Number of impeller blades		4			
Impeller shaft diameter	in. mm	1 9/16" 40			
Height - impeller center	in. mm	15" 381		18 1/2" 470	
Impeller RPM		540 RPM			
Required RPM for the tractor PTO		540 RPM			
Number of auger		1			
Main auger diameter	in. mm	16" 406		21 1/4" 540	
Bearing / ductile iron casting	in. mm	1 1/4" 32		1 1/2" 38	
Drive chain - main auger		60		80	
Number of shear bolts		1 for impeller + 1 for auger			
PTO		T50		T60	
Scraper blade		High quality steel (not reversible)		High quality steel (reversible)	
- Option semi-industrial, Hardox 450		INV-SIT1-74	INV-SIT1-80	INV-SIT1-92	INV-SIT1-92-102
- Option Tivar		INV-TV-74	INV-TV-80	INV-TV-92	INV-TV-92-102
- Option stainless steel		INV-SST-74	INV-SST-80	INV-SST-92	INV-SST-92-102
Adjustable skid shoes	Quick adjust	-		High quality steel	
- Option Hardox 450		PHD-4872		PHD-7486	
- Option Hardox 600		-		PSHD-7486	
- Option stainless steel		PST-4872		PST-7486	
Chute	Semi-industrial	PSIG-INV-GRI		PSIG-INV-GRII	
Chute rotation	With hydraulic motor	MLH-125		MLH-315-R	
Chute rotation angle : adjustable		270° to 345°		270° to 335°	
Antifriction for chute		Ring			
Deflector	Hydraulic cylinder	25TR04		25TR08	
Color (including primer)		Pronovost red ¹			
Approx. weight blade and cylinder	lbs kg	90 41	94 43	154 70	162 73
Weight including chute	lbs kg	970 440	960 435	1805 819	1845 837

¹ Choice of color available in option.

Design and specifications subject to change without notice.

CHARACTERISTICS AND OPTIONS - CONTRACTORS CATEGORY

CHUTE



PSIG INCLUDED

- ✓ Pronovost Gr.I
- ✓ Pronovost Gr.II
- ✓ Pronovost Gr.III
- ✓ Pronovost GV
- ✓ PXPL / X-PRO
- ✓ Cyclone
- ✓ Inverted P-INV



PC3C-GR1

- ✓ Pronovost Gr.I
- ✓ PXPL-80
- ✓ C7224
- ✓ C8026

PC3C-GR1.5

- ✓ P-82126-HP
- ✓ P-82126TRC-HP



PCG-7486

- ✓ Pronovost Gr.II
- ✓ Pronovost GV

PCG-92104

- ✓ Pronovost Gr.III

PCG3C-GR1.5

- ✓ P-82126(TRC)-HP, GV



PRP-7486 & -2

- ✓ Pronovost Gr.II
- ✓ Pronovost GV

PRP-92104 & -2

- ✓ Pronovost Gr.III

PRP-GR1.5

- ✓ P-82126(TRC)-HP, GV



PCT-7486-HDB

- ✓ Pronovost Gr.II
- ✓ Pronovost GV

PCT-92104

- ✓ Pronovost Gr.III



PCTC-INDR

- ✓ Pronovost Gr.III

SCRAPER BLADE

SIT1 (LONG LIFE)

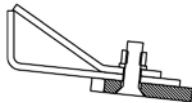

- ✓ Pronovost Gr.I

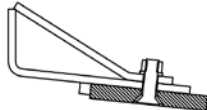

- ✓ Pronovost Gr.II
- ✓ Pronovost Gr.III
- ✓ Pronovost GV
- ✓ PXPL / X-PRO
- ✓ Inverted P-INV

T1 (EXTRA LONG LIFE)

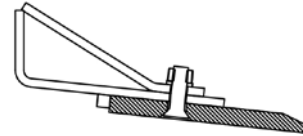

- ✓ Pronovost Gr.II
- ✓ Pronovost Gr.III
- ✓ Pronovost GV
- ✓ PXPL / X-PRO

TV (NON-AGRESSIVE AND RUST PROOF)

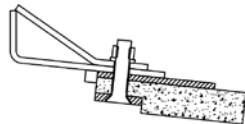

- ✓ Pronovost Gr.I

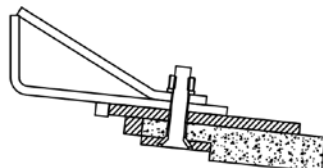

- ✓ Pronovost Gr.II
- ✓ Pronovost GV
- ✓ PXPL / X-PRO
- ✓ Inverted P-INV

SST (RUST PROOF)

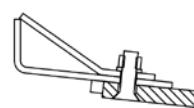

- ✓ Pronovost Gr.I

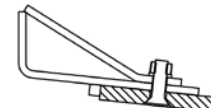

- ✓ Pronovost Gr.II
- ✓ Pronovost Gr.III
- ✓ Pronovost GV
- ✓ PXPL / X-PRO
- ✓ Inverted P-INV

CHARACTERISTICS AND OPTIONS - CONTRACTORS CATEGORY

SKID SHOES



**PHD (YELLOW)
LONG LIFE**

- ✓ Pronovost Gr.I
- ✓ Pronovost Gr.II
- ✓ Pronovost Gr.III
- ✓ Pronovost GV
- ✓ PXPL / X-PRO
- ✓ Inverted P-INV



**PSHD (RED)
EXTRA LONG
LIFE**

- ✓ Pronovost Gr.II
- ✓ Pronovost Gr.III
- ✓ Pronovost GV
- ✓ PXPL / X-PRO
- ✓ Inverted P-INV



**PST (BLUE)
RUST PROOF**

- ✓ Pronovost Gr.I
- ✓ Pronovost Gr.II
- ✓ Pronovost Gr.III
- ✓ Pronovost GV
- ✓ PXPL / X-PRO
- ✓ Inverted P-INV

RUBBER DEFLECTOR FLAP

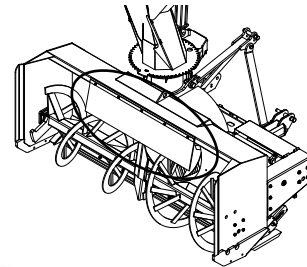

TL

- ✓ Pronovost Gr.I
- ✓ Pronovost Gr.II
- ✓ Pronovost Gr.III

PTO



Standard

- ✓ Pronovost Gr.I
- ✓ Pronovost Gr.II
- ✓ Pronovost Gr.III
- ✓ Pronovost GV
- ✓ PXPL / X-PRO
- ✓ Inverted P-INV



Multilobe

- ✓ Pronovost Gr.II
- ✓ Pronovost Gr.III
- ✓ Pronovost GV
- ✓ PXPL / X-PRO

WINGS



**CO-F
CO-HYD**

- ✓ Cyclone

LATERAL BLADES

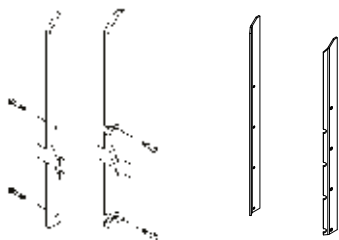

CL

- ✓ Pronovost Gr.I
- ✓ Pronovost Gr.II

CL

- ✓ Pronovost Gr.III

FULL FLIGHT AUGER

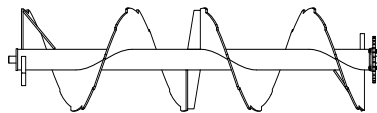

VIP

- ✓ Pronovost Gr.II
- ✓ Pronovost Gr.III

CHARACTERISTICS AND OPTIONS - CONTRACTORS CATEGORY

SPEED REDUCER



PR-7502-1

- ✓ Pronovost Gr.II
- ✓ Pronovost Gr.II



PR-7502-2

- ✓ Pronovost Gr.I
- ✓ Pronovost Gr.II



PRH-25M-1

- ✓ Pronovost Gr.II
- ✓ PXPL / X-PRO



PRH-30M-2

- ✓ Pronovost Gr.II
- ✓ Pronovost Gr.III
- ✓ Pronovost GV
- ✓ PXPL / X-PRO



PRH-25M-2

- ✓ Pronovost Gr.II
- ✓ Pronovost Gr.III
- ✓ Pronovost GV
- ✓ PXPL / X-PRO

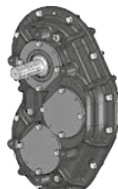

PR3G200-2

- ✓ Pronovost Gr.III

PTO DROP BOX



PRC-6501-1

- ✓ Pronovost Gr.I

OPTIONS FOR X-PRO BLADE

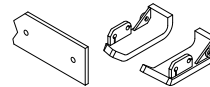

PXPLHD

- ✓ PXPL / X-PRO

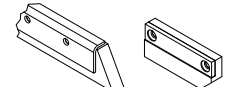

PXPLTV

- ✓ PXPL / X-PRO

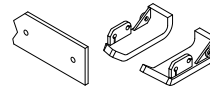

PXPLST

- ✓ PXPL / X-PRO

**REAR MOUNT
SCRAPER BLADE**



INVL

- ✓ Inverted P-INV

ACCÉLÉRATEUR



- ✓ Pronovost Gr.I

**WORKING LIGHTS
FOR CHUTE**



PKL-IND7486

- ✓ Pronovost Gr.II
- ✓ Pronovost GV

PKL-INDR

- ✓ Pronovost Gr.III

PKL-IND92104

- ✓ Pronovost Gr.III

PUBLIC WORKS CATEGORY



SEMI-INDUSTRIAL SNOWBLOWERS - GROUP I



HP recommended : 45 to 75 HP PTO



INCLUDED IN COMBO PRICE

- ✓ Semi-industrial chute with greasable hinges and access panel (removable).
- ✓ Hydraulic cylinder and hose support for deflector adjustment.
- ✓ Chute rotation kit for hydraulic motor (motor included).
- ✓ PTO category T60.
- ✓ Hardox 550 reversible scraper blade.
- ✓ Hardox 450 skid shoes.
- ✓ Hardox 450 drum wall.
- ✓ Auger chain RENOLD #80HV in oil bath.
- ✓ Large diameter double ribbed serrated auger.
- ✓ Industrial Yellow color.

SUGGESTED RETAIL

HP	MODEL	COMBO RETAIL PRICE
45 to 75	PGS-740	18,648. \$
45 to 75	PGS-800	18,851. \$

CHARACTERISTICS

- Efficient in hard packed snow and ice, as well as in powdered snow.
- Weight on the tractor's 3 point hitch comparable to a Pronovost P-800.
- Chute on antifriction ring with gear driven rotation by hydraulic motor.
- Automatic double chain binder.
- Best performance of the industry.
- Scraper blade inclined at 45°.
- Ultra floating skid shoes.



HOSE KIT	RETAIL PRICE	
	FOR BASIC FUNCTIONS	
PGS-740 and PGS-800	PKB-GR1	423. \$
Includes hydraulic hoses connecting the tractor oil outlets to the deflector adjustment cylinder and the chute rotation motor . *Installation not included.		

FREIGHT CHARGES	F.O.B. St-Tite - Refer to the list of shipping costs.
-----------------	-------------------------------------------------------

WARRANTY : One (1) year on manufacturing defects - void if product has been altered or misused.
 The PTO shaft warranty is given by the manufacturer and applies only to manufacturing defects.
 Prices and Specifications subject to change without notice. ALL TAXES EXTRA WHEN APPLICABLE.



SEMI-INDUSTRIAL SNOWBLOWERS - GROUP I



SPECIFICATIONS		PGS-740	PGS-800
HP recommended (HP PTO)	min. - max.	45 - 75	
Working width	in. mm	74" 1880	80" 2032
Cutting height	in. mm	36 3/4" 933	
Cutting height - lateral blades	in. mm	58 1/2" 1486	
Height - chute base	in. mm	35" 889	
Hitch category	in. mm	2 - 30 1/2" 775	
Drum diameter	in. mm	28" 711	
Depth of drum	in. mm	10 1/2" 267	
Drum wall		Hardox 450 - 3/16"	
Number of impeller blades		4 - 3/8" thick, high quality steel, welded	
Impeller shaft diameter	in. mm	1 9/16" 40	
Height - impeller center	in. mm	18" 457	
Impeller RPM		540 RPM	
Required RPM for the tractor PTO		540 RPM	
Number of auger		1	
Main auger diameter	in. mm	28" 711 double ribboned, welded, serrated	
Bearing / ductile iron casting	in. mm	Right : 1 1/2" 38 Left : 2" 51	
Drive chain - main auger		Renold No. 80HV in oil bath	
Number of shear bolts		1 for impeller + 1 for auger	
Included PTO (optional)		T60	
Lateral blades		High quality steel 5/16" x 3 1/2"	
Scraper blade	Semi-industrial	Hardox 550 - 3/8" x 8 5/8" reversible, not sharpened	
- Option stainless steel		3/8" x 7" not reversible, not sharpened	
Adjustable skid shoes	Quick adjust	High quality steel (2 skid shoes)	
Chute	Semi-industrial	PSIR-5472	
Chute rotation	With hydraulic motor	MLH-250-R	
Chute rotation maximum angle	Hydraulic motor rotation	270° to 345° adjustable	
Antifriction for chute		Ring	
Deflector	Hydraulic cylinder	25TR04	
Color (including primer)		Frame : Industrial yellow Auger and chute : Pronovost red	
Center of gravity from 3 point hitch at its shortest	in. mm	30 1/2" 775	
Rotational force (reference)	lbs-in	46 177	47 733
Weight including PSIG chute	lbs kg	1514 687	1565 710

Design and specifications subject to change without notice.



SEMI-INDUSTRIAL SNOWBLOWERS - GROUP III



HP recommended : 100 to 200 HP PTO

INCLUDED IN COMBO PRICE

- ✓ Semi-industrial chute with greasable hinges and access panel (removable).
- ✓ Hydraulic cylinder and hose support for deflector adjustment.
- ✓ Chute rotation kit for hydraulic motor (motor included).
- ✓ Hydraulic motor for rotary drum rotation.
- ✓ PTO category T90 (choice of yoke as required by RPM and tractor).
- ✓ High quality steel scraper blade, reversible.
- ✓ Quick adjust skid shoes, high quality steel.
- ✓ Hardox 450 drum wall.
- ✓ Chain RENOLD #100HV in oil bath.
- ✓ Open flight serrated auger.
- ✓ Storage support.
- ✓ Rubber deflector flap at the top of the frame.
- ✓ Industrial Yellow color.

NB.: Wider models can also be made on request and depending on the production schedule. Subject to conditions, please contact customer service for details.

SUGGESTED RETAIL

HP PTO 540 RPM	HP PTO 1000 RPM	MODEL	COMBO RETAIL PRICE
100 to 150	125 to 200	PGS-1020TRC	33,130. \$
100 to 150	125 to 200	PGS-1080TRC	33,700. \$

OPTION	DESCRIPTION	SURCHARGE PRICE	RETAIL PRICE
CHOICE OF CHUTE			
PSIG-92104	Semi-industrial chute with greasable hinges and removable access panel including hose support for deflector cylinder.	Included in combo	2,006. \$
PCG-92104	Quick attach industrial chute with greasable hinges and removable access panel including hose support for deflector cylinder.	Surcharge on combo price 2,012.¹ \$	4,018. \$
PRP-92104-2	24" extension for industrial chute. * PKB available, price on demand.		1,428. \$
PRP-92104	48" extension for industrial chute. * PKB available, price on demand.		1,629. \$
PCT-92104	Hydraulic telescopic industrial chute, a versatile chute for general use, with greasable hinges and access panel, including extension cylinders and hose support + hose support for deflector cylinder.	Surcharge on combo price 5,299.¹ \$	7,305. \$
PCTC-INDR	Hydraulic telescopic industrial chute with rounded deflector designed for truck loading, greasable hinges and access panel, including 2 extension cylinders, hose support, 2 deflector cylinders and hose support.	Surcharge on combo price 8,369.¹ \$	10,375. \$
WORKING LIGHTS FOR CHUTE			RETAIL PRICE
PKL-IND92104	Mounting kit for working lights on telescopic chute PCT-92104.		505. \$
PKL-INDR	Mounting kit for working lights on telescopic chute PCTC-INDR.		505. \$

¹ Surcharge for option in replacement of the regular component or on the combo price. See combos page 82.



SEMI-INDUSTRIAL SNOWBLOWERS - GROUP III



HOSE KIT				RETAIL PRICE		
	FOR BASIC FUNCTIONS		WITH TELESCOPIC CHUTE PCT-92104		WITH TELESCOPIC CHUTE ROUND DEFLECTOR PCTC-INDR	
PGS-1020TRC and PGS-1080TRC	PKB-GR3TRC	737. \$	PKB-GR3TRC-T	1,149. \$	PKB-GR3TRC-TR 1,159. \$	
	Includes hydraulic hoses connecting the tractor oil outlets to the deflector adjustment cylinder , the chute rotation motor and the drum rotation motor .					
			...and the telescopic chute lift cylinders .			
	* Installation not included.					
SCRAPER BLADE				SURCHARGE PRICE		
	Hardox 450, reversible, not sharpened 1/2" x 4". ^{1,2}		Hardox 450, not reversible, sharpened 1/2" x 6". ^{1,2}		Stainless steel, reversible, not sharpened 1/2" x 4". ^{1,2,3}	
PGS-1020TRC	SIT1-102	300.¹ \$	T1-102	494.¹ \$	SST-102 459.¹ \$	
PGS-1080TRC	SIT1-108	322.¹ \$	T1-108	534.¹ \$	SST-108 473.¹ \$	
SKID SHOES				SURCHARGE PRICE		
PHD-PGS	Industrial skid shoes, Hardox 450 soles. ^{1,2}				206.¹ \$	
PSHD-PGS	Industrial skid shoes, Hardox 600 soles. ^{1,2}				318.¹ \$	
PST-PGS	Skid shoes, stainless steel soles. ^{1,2}				362.¹ \$	
LATERAL BLADES				RETAIL PRICE		
CL-1020PGS	Lateral blades 3/8" x 5 1/2" x 78" with brace. ⁴				874. \$	
SPEED REDUCER				RETAIL PRICE		
IMPORTANT: When ordering a speed reducer, select the required PTO shaft below.						
PRH-30M-2	Speed reducer 1000/555 RPM 100 HP at 220 HP at 1000 RPM - 3 gears - shafts 7 1/16" c/c.				3,901. \$	
PRH-25M-2	Drop box 1000/540 RPM with two choices of input shafts : Reducer inverter 225 HP at 1000 RPM - 2/3 gears - shafts 6 3/4" c/c or reducer 175 HP at 1000 RPM - 3/3 gears - shafts 8" c/c.				4,074. \$	
PR3G200-2	Reducer 1000/555 (200 HP at 1000 RPM) 3 gears - 8" c/c.				6,083. \$	
IMPORTANT : When using a 1000/540 speed reducer, make sure to use a 10 mm shear bolt or a 12 mm shear bolt reduced to 3/8" according to model of drive shaft (PTO).						
CHOICE OF PTO				SURCHARGE PRICE		RETAIL PRICE
For PGS-1020TRC and PGS-1080TRC						
9475	T90 PTO 1 3/8"-6 & 1 3/4"-20 (540 RPM)			Included in combo	1,297. \$	
9475-1	T90 PTO 1 3/8"-21 & 1 3/4"-20 (1000 RPM)			88.¹ \$	1,385. \$	
9475-2	T90 PTO 1 3/4"-20 & 1 3/4"-20 (1000 RPM)			88.¹ \$	1,385. \$	
9598	V90 Multilobe PTO 1 3/8"-6 & 1 3/4"-20 (540 RPM)			342.¹ \$	1,639. \$	
9599	V90 Multilobe PTO 1 3/8"-21 & 1 3/4"-20 (1000 RPM)			378.¹ \$	1,675. \$	
9604	V90 Multilobe PTO 1 3/4"-20 & 1 3/4"-20 (1000 RPM)			378.¹ \$	1,675. \$	

¹ Surcharge for option in replacement of the regular component or on the combo price. See combos page 82.

² **Cutting edge and skid shoe wear - not warranted.**

³ Steel bolts included. Stainless steel bolts can be ordered from our parts department.

⁴ Increase the width by 3/4".

**SEMI-INDUSTRIAL SKID SHOES - GROUP III**

KIT OF 3 OR 4 DIVERTERS WITH JOYSTICK		RETAIL PRICE
KVD-3IND	Kit of 3 electric directionnal control valves to control 4 hydraulic functions (chute deflector, chute rotation, telescopic chute and TRC drum) including universal mounting bracket, hoses and fittings. Installation not included.	3,200 \$
KVD-4IND	Kit of 4 electric directionnal control valves to control 5 hydraulic functions (chute deflector, chute rotation, telescopic chute, TRC drum and hydraulic lateral blades) including universal mounting bracket, hoses and fittings. Installation not included.	3,925. \$
KVD-IND-M4	Kit of joystick controller 4 buttons with cables and connector. Installs on a hydraulic lever or tractor. Compatible for KVD-3IND + KVD-4IND). Installation not included.	645. \$
KVD-IND-H20	Wiring harness and connector 20'. Installation not included.	212. \$
CHARACTERISTICS AND OPTIONS ILLUSTRATED ON PAGES 70 TO 72.		

FREIGHT CHARGES	F.O.B. St-Tite - Refer to the list of shipping costs.
------------------------	--------------------------------------------------------------

WARRANTY : One (1) year on manufacturing defects - void if product has been altered or misused.
The PTO shaft warranty is given by the manufacturer and applies only to manufacturing defects.
Prices and Specifications subject to change without notice. ALL TAXES EXTRA WHEN APPLICABLE.



SEMI-INDUSTRIAL SNOWBLOWERS - GROUP III



SPECIFICATIONS		PGS-1020TRC	PGS-1080TRC
Recommended HP (HP PTO)	min. - max.	100 - 150	
Approximate performance		1500 tons imp. / hour	
Working width	in. mm	102" 2591	108" 2743
Cutting height	in. mm	47 1/2" 1207	
Cutting height - lateral blades (Opt. CL)	in. mm	66" 1676 or 78" 1981	
Height - chute base, TRC model	in. mm	49 1/2" 1257	
Height with telescopic chute, TRC model	in. mm	PCT-92104 : 119" 3022 closed, 149" 3785 extended PCTC-INDR : 124" 3150 closed, 156" 3962 extended	
Hitch category	in. mm	2 - 38 1/2" 978	
Drum diameter	in. mm	34" 864	
Depth of drum	in. mm	15" 381	
Drum wall		Hardox 450 - 1/4"	
Number of impeller blades		6 - 1/2" thick, high quality steel, welded	
Impeller shaft diameter	in. mm	2" 51	
Height - impeller center	in. mm	22" 559	
Impeller RPM		540 RPM	
Required RPM for the tractor PTO		540 RPM Opt. 1000 RPM	
Number of auger		1	
Main auger diameter	in. mm	34" 864 - double ribboned, bolted, serrated	
Bearing / ductile iron casting	in. mm	2 1/2" 64	
Drive chain - main auger		Renold No. 100HV in oil bath	
Frame : sides		Plate 1/4"	
Frame : back		Plate 10 gauge	
Number of shear bolts		1 for impeller + 1 for auger	
Hydraulic motor for drum rotation		MLH-315-R	
Reducer (option)		PRH-30M-2 or PRH-25M-2	
Height of reducer shaft		14" or 30" (with reducer 150 HP)	
Included PTO (optional)		T90, choice of yoke depending on tractor and RPM (V90 multilobe, choice of yoke depending on tractor and RPM)	
Lateral blades		High quality steel	
Scraper blade		High quality steel	
- Option semi-Industrial, Hardox 450		SIT1-102	SIT1-108
- Option industrial, Hardox 450		T1-102	T1-108
- Option stainless steel		SST-102	SST-108
Adjustable skid shoes	Quick adjust	High quality steel (2 skid shoes)	
- Option Hardox 450		PHD-PGS (2 skid shoes)	
- Option Hardox 600		PSHD-PGS (2 skid shoes)	
- Option stainless steel		PST-PGS (2 skid shoes)	
Chute	Semi-Industrial	PSIG-92104	
- Option industrial, quick attach		PCG-92104	
- Option 24" or 48" extension		PRP-92104(-2)	
- Option telescopic including lift cylinders		PCT-92104	
- Option telescopic, round deflector, including lift cylinder and deflector cylinders.		PCTC-INDR	
Chute rotation	With hydraulic motor	MLH-315-R	
Chute rotation maximum angle	Rotation by hydraulic motor	305°	
Antifriction for chute		Ring	
Deflector	Hydraulic cylinder	25TR08	
Color (including primer)		Industrial yellow	
Storage support		✓	
Center of gravity from the 3 point hitch at its shortest	in. mm	44" 1118	
Rotational force (reference)	lbs-in	169 180	173 184
Weight including telescopic chute	lbs kg	3845 1744	3936 1785

Design and specifications subject to change without notice.



INDUSTRIAL SNOWBLOWERS - OPEN FLIGHT AUGER



HP recommended : 120 to 350 HP PTO

INCLUDED IN COMBO PRICE

- ✓ Chute rotation kit for hydraulic motor (motor included).
- ✓ PTO category V90, multilobe (up to 275 HP).
- ✓ Hardox 450 scraper blade, removable, sharpened.
- ✓ Skid shoes (adjustment with spacers), Hardox 600 sole.
- ✓ Hydraulic motor for drum rotation with reduction system.
- ✓ Speed reducer and inverter.
- ✓ Rubber deflector flap at the top of the frame.
- ✓ Basic lateral blades, high quality steel.
- ✓ Industrial yellow color.

SUGGESTED RETAIL

	HP	MODEL	COMBO RETAIL PRICE
Single auger models	120 to 200	PGV-1021TRC	50,940. \$
	225 to 350	PGV-120137TRC	68,081. \$
Dual auger models	225 to 350	PGV-1022TRC	69,783. \$
	225 to 350	PGV-1202TRC	72,869. \$

NB.: Wider models can also be made on request and depending on the production schedule. Subject to conditions, please contact customer service for details.

OPTION	DESCRIPTION		SUGGESTED RETAIL	
CHOICE OF CHUTE			RETAIL PRICE	
PCTC-IND	Hydraulic telescopic industrial chute, a versatile chute for general use, including deflector cylinder, chute extension cylinders and 2 hose supports, carbon steel chute and deflector backs, greasable hinges.		9,374. \$	
PCTC-INDR	Hydraulic telescopic industrial chute with rounded deflector designed for truck loading, greasable hinges and access panel, including 2 extension cylinders and hose support and 2 deflector cylinders and hose support.		10,375. \$	
<i>N.B. Chutes from Group III (red) may be used on these snowblowers.</i>				
WORKING LIGHTS FOR CHUTE			RETAIL PRICE	
PKL-IND92104	Mounting kit for working lights on telescopic chute PCTC-IND.		505. \$	
PKL-INDR	Mounting kit for working lights on telescopic chute PCTC-INDR.		505. \$	
HOSE KIT			RETAIL PRICE	
	FOR BASIC FUNCTIONS	WITH TELESCOPIC CHUTE PCT-92104 OR PCT-IND	WITH TELESC. CHUTE ROUND DEFLECTOR PCTC-INDR	FOR HYDRAULIC LATERAL BLADES OPTION
PGV-1021TRC, PGV-120137TRC, PGV-1022TRC, PGV-1202TRC	PKB-GR3TRC 737. \$	PKB-GR3TRC-T 1,149. \$	PKB-GR3TRC-TR 1,159. \$	PKB-IND-CLH 285. \$
	Includes hydraulic hoses connecting the tractor oil outlets to the deflector adjustment cylinder , the chute rotation motor , the drum rotation motor (TRC models only).			Includes hydraulic hoses connecting the tractor oil outlets to the lateral blades cylinder .
	... and the telescopic chute lift cylinders .			
* Installation not included.				



INDUSTRIAL SNOWBLOWERS - OPEN FLIGHT AUGER



LATERAL BLADES		SURCHARGE PRICE	RETAIL PRICE
PGV-1021TRC and PGV-120137TRC			
CLN-982	Lateral blades, high quality steel.	Included in combo	412. \$
CL-1021PGV	Lateral blades 5/8" x 5 3/4" x 78" carbon steel. ¹	2,372.¹ \$	2,783. \$
CLH-1021PGV CLH-120137PGV	Hydraulic lateral blades 5/8" x 7 1/2" x 78", Hardox 450 sharpened with cylinder 25TRO8 included. ¹	4,868.¹ \$	5,279. \$
PGV-1022TRC and PGV-1202TRC			
CLN-1022PGV	Lateral blades, high quality steel.	Included in combo	487. \$
CL-1022PGV	Lateral blades 5/8" x 5 3/4" x 96 1/2" carbon steel. ¹	2,622.¹ \$	3,109. \$
CLH-1022PGV CLH-1202PGV	Hydraulic lateral blades 5/8" x 7 1/2" x 96 1/2" Hardox 450 sharpened with 25TRO8 cylinder included. ¹	5,205.¹ \$	5,692. \$
LATERAL SKID SHOES			RETAIL PRICE
PHCT-PGV	Lateral skid shoe for sidewalk, extra long life sole. Right side or left side.		400. \$
SPEED REDUCER		SURCHARGE PRICE	RETAIL PRICE
IMPORTANT: When ordering a speed reducer, select the required PTO shaft below.			
PGV-1021TRC			
PR2G-250-2	Speed reducer and inverter (300 HP at 1000 RPM) - 2 gears - 1000/562 - shafts 6 3/4" c/c included (casing ready for connecting the oil cooler RH250-PGV-1022) (350 HP at 1000 RPM with oil cooler RH250-PGV-1022).	Included in combo	5,492. \$
PR3G200-2	Reducer 1000/555 (200 HP at 1000 RPM) 3 gears - 8" c/c including mounting kit PR3G200-2-KMPGV.	591.¹ \$	6,083. \$
PGV-120137TRC, PGV-1022TRC and PGV-1202TRC			
PR2G-250-3	Speed reducer and inverter (300 HP at 1000 RPM) - 2 gears - 1000/562 - shafts 6 3/4" c/c included with (casing ready for connecting the oil cooler RH250-PGV-1022) (350 HP at 1000 RPM with oil cooler RH250-PGV-1022).	Included in combo	5,540. \$
PR3G275-3	Reducer 1000/562 (300 HP at 1000 RPM) 3 gears - 10" c/c., including mounting kit PR3G250-2.5-KMPGV (350 HP at 1000 RPM with oil cooler RH250-PGV-1022).	0.¹ \$	5,540. \$
PRH-60M-3	Speed reducer with 2 input choices 1000/540. Inverter and non-inverter 500 HP.		Price on demand
CHOICE OF PTO		SURCHARGE PRICE	RETAIL PRICE
PGV-1021TRC, PGV-120137TRC, PGV-1022TRC and PGV-1202TRC			
9599	V90 Multilobe PTO 1 3/8"-21 & 1 3/4"-20 (1000 RPM)	Included in combo	1,675. \$
9604	V90 Multilobe PTO 1 3/4"-20 & 1 3/4"-20 (1000 RPM)	0.¹ \$	1,675. \$
400-00601	V12 Multilobe PTO 1 3/4"-20 & 1 3/4"-20 (1000 RPM) Recommended from 275 HP.	2,293.¹ \$	3,968. \$
OIL COOLER			RETAIL PRICE
PGV-120137TRC, PGV-1022TRC & PGV-1202TRC	RH250-PGV-1022	Oil cooler (pump and tank) <u>recommended for 300 HP and over.</u>	4,081. \$

¹ Surcharge for option in replacement of the regular component or on the combo price. See combos page 82.

**INDUSTRIAL SNOWBLOWERS - OPEN FLIGHT AUGER**

KIT OF 3 OR 4 DIVERTERS WITH JOYSTICK*		RETAIL PRICE
KVD-3IND	Kit of 3 electric directionnal control valves to control 4 hydraulic functions (chute deflector, chute rotation, telescopic chute and TRC drum) including universal mounting bracket, hoses and fittings.	3,200. \$
KVD-4IND	Kit of 4 electric directionnal control valves to control 5 hydraulic functions (chute deflector, chute rotation, telescopic chute, TRC drum and hydraulic lateral blades) including universal mounting bracket, hoses and fittings.	3,925. \$
KVD-IND-M4	Kit of joystick controller 4 buttons with cables and connector. Installs on a hydraulic lever or tractor. Compatible for KVD-3IND + KVD-4IND.	645. \$
KVD-IND-H20	Wiring harness and connector 20'.	212. \$
LATERAL PROTECTOR		RETAIL PRICE
PL-IND	Lateral protector in Tivar for protection of snow loading equipment.	696. \$
CHARACTERISTICS AND OPTIONS ILLUSTRATED ON PAGES 70 TO 72.		

* Installation not included.

FREIGHT CHARGES

F.O.B. St-Tite - Refer to the list of shipping costs.

WARRANTY : One (1) year on manufacturing defects - void if product has been altered or misused.
The PTO shaft warranty is given by the manufacturer and applies only to manufacturing defects.
Prices and Specifications subject to change without notice. ALL TAXES EXTRA WHEN APPLICABLE.



INDUSTRIAL SNOWBLOWERS - OPEN FLIGHT AUGER



SPECIFICATIONS

MODEL	PGV-1021TRC	PGV-120137TRC	PGV-1022TRC	PGV-1202TRC
HP recommended (HP PTO) min. - max.	120 - 200	225 - 350		
Approximate performance	1600 tons imp. / hour		2500 tons imp. / hour	
Working width in. mm	102" 2591	118" 2997	102" 2591	118 1/4" 3004
Cutting height in. mm	53" 1346		68 1/4" 1734	
Cutting height - lateral blades in. mm	Included : 59" 1499 Opt. CL : 78" 1981 Opt. CLH : 78" 1981		Included : 75 1/2" 1918 Opt. CL : 96 1/2" 2451 Opt. CLH : 96 1/2" 2451	
Height - chute base - TRC models in. mm	51 1/2" 1308		54 1/2" 1384	
Height with telescopic chute, TRC models in. mm	PCTC-IND : 129" 3277 C 160 1/2" 4077 E PCTC-INDR : 126" 3200 C 158" 4013 E		PCTC-IND : 131" 3327 C 162 1/2" 4128 E PCTC-INDR : 129" 3277 C 161" 4089 E	
C = Closed E = Extended				
Hitch category in. mm	2 & 3- 35" 889			
Drum diameter in. mm	34" 864		37" 940	
Depth of drum in. mm	15" 381		15" 381	
Drum position	Offset on 6" right		Offset of 5" right	
Drum wall	Hardox 450 1/4"		Hardox 450 3/8"	
Number of impeller blades	6 - 3/8" thick, replaceable, Hardox 450			
Impeller shaft diameter in. mm	2" 51		2 1/2" 64	
Height - impeller center in. mm	22 1/4" 565		24" 610	
Impeller RPM	540 inverted			
Required RPM for the tractor PTO	1000 RPM			
Number of auger	1		2	
Main auger diameter in. mm	34" 864 - removable hub, dual band, bolted, welded carbon teeth			
Upper auger in. mm	-		20" 508 - removable hub, single band, welded Hardox 450 teeth	
Bearing / ductile iron casting in. mm	2 1/2" 64			
Drive chain - main auger	Renold No. 100HV in oil bath			
Frame : sides	Plate 1/4"	Left 5/16"	Plate 5/16"	
Frame : back	Plate 10 Gauge	Plate 3/16"	Plate 9 Gauge and 3/16"	
Number of shear bolts	1 for impeller + 1 for auger			
Hydraulic motor for drum rotation	MLH-315-R			
Drum rotation with reduction system	On antifriction with hydraulic motor and cushion valve included			
Reducer inverter	PR2G-250-2		PR2G-250-3	
Height of reducer shaft	Adjust. from 27 3/8" to 19 1/4"	Adjust. from 25 7/8" to 18"	Adjustable from 29 7/8" to 18"	
Included PTO (optional)	V90 multilobe, choice of yoke depending on tractor (opt. PAV-12)			
Oil cooler (increases capacity over 300 HP)	RH250-PGV-1021		RH250-PGV-1022	
Lateral blades	High quality steel 1/2" x 5 3/4" x 59"		High quality steel 1/2" x 5 3/4" x 75 1/2"	
- Option Hardox 450	CL-1021PGV		CL-1022PGV	
- Option hydraulic blades (25TR08 cylinder included)	CLH-1021PGV	CLH-120137PGV	CLH-1022PGV	CLH-1202PGV
Scraper blade	Industrial, Hardox 450 1/2" x 6" not reversible, sharpened, ass. to 6 degrees	Industrial, Hardox 450 5/8" x 6" nor reversible, sharpened, ass. to 6 degrees		
Adjustable skid shoes	Hardox 600, 4 skid shoes, adjustment by spacers			
Hardox 600 lateral blade for sidewalk	Opt. (right or left side)			
Chute				
- Option telescopic	PCTC-IND			
- Option telescopic with round deflector	PCTC-INDR			
Chute rotation	With hydraulic motor	MLH-315-R		
Chute rotation maximum angle	Rotation by hydraulic motor	305 °		
Antifriction for chute	Ring			
Deflector	Hydraulic cylinder	Included with chute		
Color (including primer)	Industrial yellow			
Storage support	✓			
Center of gravity from the 3 point hitch at its shortest in. mm	39" 991		40 1/2" 1016	
Rotational force (reference) lbs-in	173 550	204 448	222 079	229 701
Weight TRC model ¹ lbs kg	4450 2019	5231 2373	5475 2484	5663 2569

¹ Weight including PCTC-IND chute and reducer.

Design and specifications subject to change without notice.



INDUSTRIAL SNOWBLOWERS - FULL FLIGHT AUGER



HP recommended : 120 to 350 HP PTO



INCLUDED IN COMBO PRICE

- ✓ Chute rotation kit for hydraulic motor (motor included).
- ✓ PTO category V90, multilobe.
- ✓ Hardox 450 scraper blade, removable, sharpened.
- ✓ Quick adjust skid shoes, Hardox 600 soles.
- ✓ Hydraulic motor for drum rotation with reduction system.
- ✓ Welded carbon teeth on both full flight serrated augers.
- ✓ Basic lateral blades, high quality steel.
- ✓ Storage support.
- ✓ Industrial yellow color.

NB.: Wider models can also be made on request and depending on the production schedule. Subject to conditions, please contact customer service for details.

SUGGESTED RETAIL

HP	MODEL	COMBO RETAIL PRICE
120 to 200	P-982TRC	43,293. \$
225 to 350	P-1022TRC	59,708. \$

OPTION	DESCRIPTION	SUGGESTED RETAIL
CHOICE OF CHUTE		RETAIL PRICE
PCG-IND	Quick attach industrial chute including hose support and cylinder for deflector, carbon steel chute and deflector backs, greasable hinges.	5,962. \$
PRP-IND	48" extension for industrial chute with carbon steel back. <i>* PKB available, price on demand.</i>	2,325. \$
PCT-IND	Hydraulic telescopic industrial chute, a versatile chute for general use, including deflector cylinder, chute extension cylinders and 2 hose supports, carbon steel chute and deflector backs, greasable hinges.	9,374. \$
PCTC-INDR	Hydraulic telescopic industrial chute with rounded deflector designed for truck loading, greasable hinges and access panel, including 2 extension cylinders and hose support and 2 deflector cylinders and hose support.	10,375. \$
<i>N.B. Chutes from Group III (red) may be used on snowblowers.</i>		
WORKING LIGHTS FOR CHUTE		RETAIL PRICE
PKL-IND92104	Mounting kit for working light on telescopic chute PCT-IND.	505. \$
PKL-INDR	Mounting kit for working light on telescopic chute PCTC-INDR.	505. \$



INDUSTRIAL SNOWBLOWERS - FULL FLIGHT AUGER



HOSE KIT						RETAIL PRICE		
FOR BASIC FUNCTIONS		WITH TELESCOPIC CHUTE PCT-92104 OU PCT-IND		WITH TELESCOPIC CHUTE ROUND DEFLECTOR PCTC-INDR		FOR HYDRAULIC LATERAL BLADES OPTION		
P-982TRC and P-1022TRC	PKB-GR3TRC	737. \$	PKB-GR3TRC-T	1,149. \$	PKB-GR3TRC-TR	1,159. \$	PKB-IND-CLH	285. \$
Includes hydraulic hoses connecting the tractor oil outlets to the deflector adjustment cylinder , the chute rotation motor and the drum rotation motor .						Includes hydraulic hoses connecting the tractor oil outlets to the lateral blades cylinder .		
and the telescopic chute lift cylinders .								
* Installation not included.								

LATERAL BLADES		SURCHARGE PRICE		RETAIL PRICE	
P-982TRC					
CLN-982	Lateral blades, high quality steel.			Included in combo	412. \$
CL-982	Lateral blades 5/8" x 5 3/4" x 77" carbon steel. ¹			2,371. ¹ \$	2,783. \$
CLH-982	Lateral hydraulic blades 5/8" x 7 1/2" x 77" Hardox 450 sharpened with 25TR08 cylinder included. ¹			4,867. ¹ \$	5,279. \$
P-1022TRC					
CLN-1022	Lateral blades, high quality steel.			Included in combo	487. \$
CL-1022	Lateral blades 5/8" x 5 3/4" x 84" carbon steel. ¹			2,622. ¹ \$	3,109. \$
CLH-1022	Lateral hydraulic blades 5/8" x 7 1/2" x 84" Hardox 450 sharpened with 25TR08 cylinder included. ¹			4,874. ¹ \$	5,361. \$

LATERAL SKID SHOE		RETAIL PRICE	
PHCT-IND	Lateral skid shoe with extra long life for sidewalk. Right side only.	321. \$	

SPEED REDUCER		RETAIL PRICE	
IMPORTANT: When ordering a speed reducer, select the required PTO shaft below.			
P-982TRC			
PRH-30M-2	Reducer 1000/555 (220 HP at 1000 RPM) 3 gears - 7 1/16" c/c.	3,901. \$	
PRH-25M-2	Drop box 1000/540 RPM with two choices of input shafts : Reducer inverter (225 HP at 1000 RPM) - 2/3 gears - shafts 6 3/4" c/c. or reducer 175 HP at 1000 RPM - 3/3 gears - shafts 8" c/c.	4,074. \$	
PR3G200-2	Reducer 1000/555 (200 HP at 1000 RPM) 3 gears - 8" c/c.	6,083. \$	
P-1022TRC			
PRH-30M-2.5	Reducer 1000/555 (220 HP at 1000 RPM) 3 gears - 7 1/16" c/c.	4,222. \$	
PR3G250-2.5	Reducer 1000/562 (300 HP at 1000 RPM) 3 gears - 10" c/c. (350 HP at 1000 RPM with oil cooler RH250-PGV-1022).	7,182. \$	
PRH-25M-2.5	Drop box 1000/540 RPM with two choices of input shafts : Reducer inverter (225 HP at 1000 RPM) - 2/3 gears - shafts 6 3/4" c/c. or reducer 175 HP at 1000 RPM - 3/3 gears - shafts 8" c/c.	4,653. \$	
IMPORTANT : When using a 1000/540 speed reducer, make sure to use a 10 mm shear bolt or a 12 mm shear bolt reduced to 3/8" according to model of drive shaft (PTO).			

¹ Surcharge for option in replacement of the regular component or on the combo price. See combos page 82.



INDUSTRIAL SNOWBLOWERS - FULL FLIGHT AUGER



CHOICE OF PTO		SURCHARGE PRICE	RETAIL PRICE
P-982TRC			
9599	V90 Multilobe PTO 1 3/8"-21 & 1 3/4"-20 (1000 RPM)	Included in combo	1,675. \$
9604	V90 Multilobe PTO 1 3/4"-20 & 1 3/4"-20 (1000 RPM)	0.¹ S	1,675. \$
9598	V90 Multilobe PTO 1 3/8"-6 & 1 3/4"-20 (540 RPM)	(36.¹ S)	1,639. \$
P-1022TRC			
9599	V90 Multilobe PTO 1 3/8"-21 & 1 3/4"-20 (1000 RPM)	Included in combo	1,675. \$
9604	V90 Multilobe PTO 1 3/4"-20 & 1 3/4"-20 (1000 RPM)	0.¹ S	1,675. \$
OIL COOLER		RETAIL PRICE	
P-1022TRC	RH250-P1022	Oil cooler (pump and tank) <u>recommended for 300 HP and over.</u> Increase capacity over 300 HP.	4,081. \$
KIT OF 3 OR 4 DIVERTERS WITH JOYSTICK			RETAIL PRICE
KVD-3IND	Kit of 3 electric directionnal control valves to control 4 hydraulic functions (chute deflector, chute rotation, telescopic chute and TRC drum) including universal mounting bracket, hoses and fittings. Installation not included.		3,200. \$
KVD-4IND	Kit of 4 electric directionnal control valves to control 5 hydraulic functions (chute deflector, chute rotation, telescopic chute, TRC drum and hydraulic lateral blades) including universal mounting bracket, hoses and fittings. Installation not included.		3,925. \$
KVD-IND-M4	Kit of joystick controller 4 buttons with cables and connector. Installs on a hydraulic lever or tractor. Compatible for KVD-3IND + KVD-4IND). Installation not included.		645. \$
KVD-IND-H20	Wiring harness and connector 20'. Installation not included.		212. \$
CHARACTERISTICS AND OPTIONS ILLUSTRATED ON PAGES 70 TO 72.			

¹ Surcharge for option in replacement of the regular component or on the combo price. See combos page 82.

FREIGHT CHARGES	F.O.B. St-Tite - Refer to the list of shipping costs.
------------------------	--------------------------------------------------------------

WARRANTY : One (1) year on manufacturing defects - void if product has been altered or misused.
The PTO shaft warranty is given by the manufacturer and applies only to manufacturing defects.
Prices and Specifications subject to change without notice. ALL TAXES EXTRA WHEN APPLICABLE.



INDUSTRIAL SNOWBLOWERS - FULL FLIGHT AUGER



SPECIFICATIONS			
MODEL		P-982TRC	P-1022TRC
HP recommended (HP PTO)	min. - max.	120 - 200	225 - 350
Approximate performance		1400 tons imp./hour	2200 tons imp./hour
Working width	in. mm	98" 2489	102" 2591
Cutting height	in. mm	52" 1321	59" 1499
Cutting height - lateral blades	in. mm	Included : 59" 1499 Opt. CL : 77" 1956 Opt. CLH : 77" 1956	Included : 62" 1575 Opt. CL : 84" 2134 Opt. CLH : 84" 2134
Height - chute base, TRC model	in. mm	52 1/2" 1334	53 1/4" 1353
Height with telescopic chute, TRC model C= Closed E= Extended	in. mm	PCT-IND : 122" 3099 C 152" 3861 E PCTC-INDR : 127" 3226 C 159" 4039 E	PCT-IND : 121" 3073 C 151" 3835 E PCTC-INDR : 126" 3200 C 158" 4013 E
Hitch category	in. mm	2 & 3 - 34 1/2" 876	
Drum diameter	in. mm	34" 864	37" 940
Depth of drum	in. mm	15" 381	
Drum wall		Hardox 450 1/4"	Hardox 450 3/8"
Number of impeller blades, Hardox 450		6- 3/8" thick, replaceable	
Impeller shaft diameter	in. mm	2" 51	2 1/2" 64
Height - impeller center	in. mm	21 3/4" 552	23" 584
Impeller RPM		540 RPM	
Required RPM for the tractor PTO		1000 RPM	
Number of augers		2 full flight augers	
Main auger diameter	in. mm	18" 457 diameter with carbon steel welded teeth	20" 508 diameter with carbon steel welded teeth
Upper auger	in. mm	18" 457 diameter with Hardox 450 welded teeth	20" 508 diameter with Hardox 450 welded teeth
Bearing /ductile iron casting	in. mm	2 7/16" 62	
Drive chain - main auger		Renold No. 100HV in oil bath	
Frame : sides		5/16"	3/8"
Frame : back		9 Gauge	3/16"
Number of shear bolts		1 for impeller + 1 for auger	
Hyd. motor for drum rotation with reduction system		On antifriction with hydraulic motor MLH-315-R	
Reducer (option)		PRH-30M-2 or 2.5, PRH-25M-2 or 2.5	PRH-30M-2 or 2.5, PR3G250-2.5, PRH-25M-2 or 2.5
PTO		V90 multilobe, yoke depending on tractor	
Oil cooler (option)		-	RH250-P1022
Lateral blades		High quality steel 1/2" x 5 3/4" x 59"	High quality steel 1/2" x 5 3/4" x 62"
- Option Hardox 450		CL-982	CL-1022
- Option hydraulic blades		CLH-982	CLH-1022
Scraper blade		Industrial, Hardox 450 1/2" x 6" not reversible, sharpened	Industrial, Hardox 450 5/8" x 6" not reversible, sharpened
Adjustable skid shoes		Hardox 600, quick adjust	
Hardox 600 lateral skid shoe for sidewalk (option)		PHCT-IND (for right side)	
Chute			
- Option industrial, quick attach		PCG-IND	
- Option 48" extension		PRP-IND	
- Option telescopic		PCT-IND	
- Option telescopic round deflector		PCTC-INDR	
Chute rotation	With hydraulic motor	MLH-315-R	
Chute rotation maximum angle	Rotation by hydraulic motor	305 °	
Antifriction for chute		Ring	
Deflector	Hydraulic cylinder	Included with chute	
Color (including primer)		Industrial yellow	
Storage support		✓	
Center of gravity from the 3 point at its shortest	in. mm	40 3/16" 1021	42 1/8" 1070
Rotational force (reference)	lbs-in	174 900	222 300
Weight including PCT chute, TRC model	lbs kg	3700 1680	4600 2088

Design and specifications subject to change without notice.



SIDEWALK SNOWBLOWERS - OPEN FLIGHT AUGER



HP recommended : 30 to 55 HP PTO

INCLUDED IN COMBO PRICE

- ✓ Semi-industrial chute with greasable hinges and access panel (removable).
- ✓ Hydraulic cylinder and hose support for deflector adjustment.
- ✓ Chute rotation kit for hydraulic motor (with motor).
- ✓ PTO category T50.
- ✓ Hardox 450 scraper blade.
- ✓ Quick adjust skid shoes, Hardox 450 soles.
- ✓ Open flight serrated auger (not illustrated).
- ✓ Yellow industrial color.

SUGGESTED RETAIL

HP	MODEL	COMBO RETAIL PRICE
30 to 55	P-542	17,269. \$

OPTION	DESCRIPTION	SURCHARGE PRICE	RETAIL PRICE
CHOICE OF CHUTE			
PSIG-5472	Semi-industrial chute with greasable hinges and access panel (removable).	Included in combo	963. \$
ADJUSTMENT FOR CHUTE DEFLECTOR			RETAIL PRICE
T-4864	Manual telescopic rod. <i>This telescopic rod replaces the 25TR04 cylinder and the TSB-4864 hose support.</i>		96. \$
HOSE KIT			RETAIL PRICE
FOR BASIC FUNCTIONS			
P-542	PKB-GR1	423. \$	
Includes hydraulic hoses connecting the tractor oil outlets to the deflector adjustment cylinder , the chute rotation motor and the drum rotation motor . * Installation not included.			
SCRAPER BLADE			SURCHARGE PRICE
TV-542	Tivar scraper blade, 1" thickness, not reversible, not sharpened, mounting kit included. ^{1,2}		589.¹ \$
SST-542	Stainless steel scraper blade, not reversible, 1/2" x 3" not sharpened. ^{1,2,3}		297.¹ \$
SKID SHOES			SURCHARGE PRICE
PST-4872	Skid shoes with stainless steel soles ^{1,2}		199.¹ \$
LATERAL BLADES			RETAIL PRICE
CL-542	Lateral blades 50" high.		262. \$
CLH-542	Hydraulic lateral blades 51" high.		4,079. \$

¹ Surcharge for option in replacement of the regular component or on the combo price. See combos page 82.

² **Cutting edge and skid shoe wear - not warranted.**

³ Steel bolts included. Steel bolts included. Stainless steel bolts can be ordered from our parts department.



SIDEWALK SNOWBLOWERS - OPEN FLIGHT AUGER



CHOICE OF PTO		SURCHARGE PRICE	RETAIL PRICE
P-542			
8114	T50 PTO 1 3/8" - 6 & 1 3/8"-6 (540 RPM)	Included in combo	485. \$
8202	T60 PTO 1 3/8"-6 & 1 3/8"-6 (540 RPM)	56.¹ \$	541. \$

CHARACTERISTICS AND OPTIONS ILLUSTRATED ON PAGES 70 TO 72.

¹ Surcharge for option in replacement of the regular componnt or on the combo price. See combos page 82.

FREIGHT CHARGES F.O.B. St-Tite - Refer to the list of shipping costs.

WARRANTY : One (1) year on manufacturing defects - void if product has been altered or misused.
The PTO shaft warranty is given by the manufacturer and applies only to manufacturing defects.
Prices and Specifications subject to change without notice. ALL TAXES EXTRA WHEN APPLICABLE.



SIDEWALK SNOWBLOWERS - OPEN FLIGHT AUGER



SPECIFICATIONS		
MODEL		P-542
HP recommended (HP PTO)	min. - max.	30 - 55
Approximate performance		550 tons imp. / hour
Working width	in. mm	55 3/8" 1406
Cutting height	in. mm	37" 940
Cutting height - lateral blades	in. mm	Opt. CLH : 47" 1194
Hitch category	in. mm	1 - 28 1/2" 726
Drum diameter	in. mm	26" 660
Depth of drum	in. mm	10 1/2" 267
Drum wall		High quality steel
Number of impeller blades		4
Impeller shaft diameter	in. mm	1 9/16" 40
Height - impeller center	in. mm	16 1/2" 419
Impeller RPM		540 RPM
Required RPM for the tractor PTO		540 RPM
Number of augers		2
Main auger diameter	in. mm	18 1/2" 470 - ribboned, serrated
Upper auger	in. mm	14" 355 - ribboned, serrated
Bearing / ductile iron casting	in. mm	1 1/4" 32
Drive chain - main auger		60
Number of shear bolts		1 for impeller + 1 for auger
PTO		T50
Lateral blades	Stationary blades	Opt. CL : 3/8" x 2 1/2" x 50"
	Hydraulic blades	Opt. CLH : 3/8" x 2 1/2" x 51"
Scraper blade	Semi-industrial	Hardox 450
<i>- Option Tivar</i>		TV-542
<i>- Option stainless steel</i>		SST-542
Adjustable skid shoes	Quick adjust	Hardox 450
	<i>- Option stainless steel</i>	PST-4872
Chute semi-industrial		PSIG-5472
<i>- Option semi-industrial, extended</i>		PSIG-5472-12
Chute rotation	Kit for hydraulic motor (with motor)	MLH-250-R
Chute rotation maximum angle	Rotation by hydraulic motor	270° to 345° adjustable
Antifriction for chute		Ring
Deflector	Hydraulic cylinder	25TR04
	<i>- Option manual telescopic rod</i>	T-4864
Color (including primer)		Industrial yellow
Storage support		✓
Weight including PSIG chute	lbs kg	1100 499

Design and specifications subject to change without notice.



SIDEWALK SNOWBLOWERS - FULL FLIGHT AUGER



HP recommended : 50 to 75 HP PTO

INCLUDED IN COMBO PRICE

- ✓ Semi-industrial chute with greasable hinges and access panel (removable).
- ✓ Hydraulic cylinder and hose support for deflector adjustment.
- ✓ Chute rotation kit for hydraulic motor (motor included).
- ✓ PTO category T60.
- ✓ Removable scraper blade, high quality steel, reversible.
- ✓ Quick adjust skid shoes, high quality steel.
- ✓ High quality steel fixed lateral blades.
- ✓ Industrial yellow color.

Sidewalk snowblower developed to meet the needs of cities and towns requiring a robust unit that can get into tight spots.

SUGGESTED RETAIL

HP	MODEL	COMBO RETAIL PRICE
50 to 75	P-254	19,060. \$

OPTION	DESCRIPTION	SURCHARGE PRICE	RETAIL PRICE
CHOICE OF CHUTE			
PSIG-7486	Semi-industrial chute with greasable hinges and removable access panel.	Included in combo	1,385. \$
PCG-7486	Quick attach industrial chute with greasable hinges and removable access panel.	Surcharge on combo price 1,007.¹ \$	2,392. \$
PRP-7486-2	24" extension for industrial chute. * PKB available, price on demand.		1,226. \$
PRP-7486	48" extension for industrial chute. * PKB available, price on demand.		1,329. \$
PCT-7486-HDB	Hydraulic telescopic industrial chute with greasable hinges and access panel, including extension cylinders and hose support + hose support for deflector cylinder. Includes replacement of chute base for telescopic chute.	Surcharge on combo price 7,582.¹ \$	8,967. \$
WORKING LIGHTS FOR CHUTE			RETAIL PRICE
PKL-IND7486	Mounting kit for working light on telescopic chute PCT-7486-HDB.		505. \$
ADJUSTMENT FOR CHUTE DEFLECTOR			RETAIL PRICE
T-74104	Manual telescopic chute. <i>This telescopic rod replaces the 25TR08 cylinder and the TSB-74104 hose support..</i>		96. \$
CHOICE OF PTO		SURCHARGE PRICE	RETAIL PRICE
P-254			
8202	T60 PTO 1 3/8"-6 & 1 3/8"-6 (540 RPM)	Included in combo	541. \$
9225-1	T80 PTO 1 3/8"-6 & 1 3/8"-6 (540 RPM)	243.¹ \$	784. \$

¹ Surcharge for option in replacement of the regular component or on the combo price. See combos page 82.



SIDEWALK SNOWBLOWERS - FULL FLIGHT AUGER



HOSE KIT		RETAIL PRICE
	FOR BASIC FUNCTIONS	WITH TELESCOPIC CHUTE PCT-7486-HDB
P-254	PKB-GR2 437. \$	PKB-GR2-T 861. \$
	Includes hydraulic hoses connecting the tractor oil outlets to the deflector adjustment cylinder , the chute rotation motor and the drum rotation motor .	Includes hydraulic hoses connecting the tractor oil outlets to the deflector adjustment cylinder , the chute rotation motor , the drum rotation motor and the telescopic chute lift cylinders .
	* Installation not included.	
SCRAPER BLADE		SURCHARGE PRICE
SIT1-254	Semi-industrial scraper blade, Hardox 450, reversible 1/2" x 4" not sharpened. ^{1,2}	264.¹ \$
T1-254	Industrial scraper blade, Hardox 450, not reversible 1/2" x 6" sharpened. ^{1,2}	380.¹ \$
SKID SHOES		SURCHARGE PRICE
PHD-7486	Industrial skid shoes with Hardox 450 sole. ^{1,2}	143.¹ \$
CHARACTERISTICS AND OPTIONS ILLUSTRATED ON PAGES 70 TO 72.		

¹ Surcharge for option in replacement of the regular component or on the combo price. See combos page 82.

² Cutting edge and skid shoe wear - not warranted.

FREIGHT CHARGES **F.O.B. St-Tite** - Refer to the list of shipping costs.

WARRANTY : One (1) year on manufacturing defects - void if product has been altered or misused.
 The PTO shaft warranty is given by the manufacturer and applies only to manufacturing defects.
 Prices and Specifications subject to change without notice. ALL TAXES EXTRA WHEN APPLICABLE.



SIDEWALK SNOWBLOWERS - FULL FLIGHT AUGER



SPECIFICATIONS		
MODEL		P-254
HP recommended (HP PTO)	min. - max.	50 - 75
Approximate performance		650 tons imp. / hour
Working width	in. mm	54" 1372
Cutting height	in. mm	51" 1295
Cutting height - lateral blades	in. mm	52" 1321
Height with telescopic chute	in. mm	PCT-7486-HD : 106 1/4" 2699 closed, 138 1/4" 3512 extended
Hitch category	in. mm	1 & 2 - 29" 737
Drum diameter	in. mm	26" 660
Depth of drum	in. mm	12" 305
Drum wall		High quality steel
Number of impeller blades		4
Impeller shaft diameter	in. mm	1 9/16" 40
Height - impeller center	in. mm	17" 432
Impeller RPM		540 RPM
Required RPM for the tractor PTO		540 RPM
Number of auger		2 full flight auger
Main auger diameter	in. mm	15" 381 diameter, serrated
Upper auger	in. mm	15" 381 diameter, serrated
Bearing / ductile iron casting	in. mm	1 1/4" 32
Drive chain - main auger		80
Number of shear bolts		1 for impeller + 1 for auger
PTO		T60
Lateral blades		High quality steel 3/8" x 2 1/2"
Scraper blade		High quality steel
- Option semi-industrial, Hardox 450		SIT1-254
- Option industrial, Hardox 450		T1-254
Adjustable skid shoes	Quick adjust	High quality steel
- Option Hardox 450, quick adjust		PHD-7486
Chute	Semi-industrial	PSIG-7486
- Option industrial, quick attach		PCG-7486
- Option extension 24" or 48"		PRP-7486(-2)
- Option telescopic		PCT-7486-HDB
Chute rotation	With hydraulic motor	MLH-315-R
Chute rotation angle : adjustable		270° to 335°
Antifriction for chute		Ring
Deflector	Hydraulic cylinder	25TR08
- Option manual telescopic rod		T-74104
Color (including primer)		Industrial yellow
Storage support		✓
Center of gravity from the 3 point hitch at its shortest	in. mm	27 3/4" 705
Weight including PSIG chute	lbs kg	1400 635

Design and specifications subject to change without notice.



SIDEWALK SNOWBLOWERS - OPEN FLIGHT AUGER



HP recommended : 45 to 65 HP PTO

INCLUDED IN COMBO PRICE

- ✓ 3-Deflector semi-industrial chute (PC3C-GR1.5) with greasable hinges and removable access panel.
- ✓ Hydraulic cylinder and hose support for deflector adjustment.
- ✓ Chute rotation kit for hydraulic motor (motor included).
- ✓ Standard PTO.
- ✓ High quality steel scraper blade, reversible.
- ✓ Open flight serrated auger.
- ✓ Quick adjust skid shoes, high quality steel.
- ✓ Hardox 450 drum wall.
- ✓ Pronovost red color.

SUGGESTED RETAIL

HP	MODEL	COMBO RETAIL PRICE
45 to 65	P-54126-GV	13,462. \$

ADJUSTMENT FOR CHUTE DEFLECTOR		RETAIL PRICE
T-4864	Manual telescopic rod. <i>This telescopic rod replaces the 25TR04 cylinder and the TSB-4864 hose support.</i>	96. \$
HOSE KIT		RETAIL PRICE
FOR BASIC FUNCTIONS		
P-54126-GV	PKB-GR1	423. \$
Includes hydraulic hoses connecting the tractor oil outlets to the deflector adjustment cylinder and the chute rotation motor . * Installation not included.		
SKID SHOES		SURCHARGE PRICE
PHD-4872	Industrial skid shoes with carbon steel soles. ^{1,2}	100.¹ \$
PST-4872	Skid shoes with stainless steel soles. ^{1,2}	199.¹ \$
SCRAPER BLADE		SURCHARGE PRICE
SIT1-154	Semi-industrial, Hardox 450, reversible, 1/2" x 3 1/2" ^{1,2}	171.¹ \$
TV-154	TIVAR, 1" thick, not reversible, including mounting kit. ^{1,2}	589.¹ \$
SST-154	Stainless steel, reversible, 1/2" x 3 1/2" ^{1,2,3}	297.¹ \$
LATERAL BLADES		RETAIL PRICE
CL-4872	Set of 2 lateral blades, high quality steel. ⁴ 3/8" x 2 1/2" x 39 1/2"	262. \$

¹ Surcharge for option in replacement of the regular component or on the combo price See combos page 82.

² **Cutting edge and skid shoe wear - not warranteed.**

³ Steel bolts included. Stainless steel bolts can be ordered from our parts department.

⁴ Increases width by 3/4".



SIDEWALK SNOWBLOWERS - OPEN FLIGHT AUGER



SPEED REDUCER		RETAIL PRICE
IMPORTANT: When ordering a speed reducer, select the required PTO shaft below.		
PR-7502-1	Inverter 540/540 RPM (1:1) - 75 HP at 540 RPM - 2 gears - shafts 4.855" c/c.	2,544. \$
PR-7502-2	Speed reducer inverter 1000/555 RPM (1.8:1) - 85 HP at 1000 RPM - 2 gears - shafts 4.855" c/c.	2,544. \$
PRC-6501-1	Non-inverting PTO drop box 540/540 RPM (1:1) - 55 HP at 540 RPM - Chain - shafts 6.5" c/c.	1,366. \$
CHOICE OF PTO		RETAIL PRICE
P-54126-GV		
8114	T50 PTO 1 3/8" - 6 & 1 3/8"-6 (540 RPM)	485. \$
8202	T60 PTO 1 3/8"-6 & 1 3/8"-6 (540 RPM)	541. \$
8202-1	T60 PTO 1 3/8"-21 & 1 3/8"-6 (1000 RPM)	612. \$
RUBBER DEFLECTOR FLAP		RETAIL PRICE
TL-5480	Located from the top of the frame to the auger. Reduces projections.	235. \$
CHOICE OF COLOR		RETAIL PRICE
PG1-02	Blue	164. \$
PG1-04	Orange	164. \$
PG1-06	INDUSTRIAL yellow	164. \$
PG1-07	Green	164. \$
PG1-09	KIO orange	164. \$
PG1-10	Black	164. \$
<i>N.B.: No cancellation for colors will be accepted.</i>		
CHARACTERISTICS AND OPTIONS ILLUSTRATED ON PAGES 70 TO 72.		

¹ Surcharge for option in replacement of the regular component or on the combo price See combos page 82.

FREIGHT CHARGES	F.O.B. St-Tite - Refer to the list of shipping costs.
------------------------	--------------------------------------------------------------

WARRANTY : One (1) year on manufacturing defects - void if product has been altered or misused. The PTO shaft warranty is given by the manufacturer and applies only to manufacturing defects. Prices and Specifications subject to change without notice. ALL TAXES EXTRA WHEN APPLICABLE.



SIDEWALK SNOWBLOWERS - OPEN FLIGHT AUGER



SPECIFICATIONS

MODEL		P-54126-GV
HP recommended (HP PTO)		45 - 65
Working width	in. mm	54" 1371
Cutting height	in. mm	30" 762
Cutting height, lateral blades (Opt. CL)	in. mm	39 1/2" 1003 <i>included</i>
Hitch category		1
Drum diameter	in. mm	26" 660
Depth of drum	in. mm	12" 305
Drum wall		Hardox 450
Number of impeller blades		4
Impeller shaft diameter	in. mm	1 9/16" 40
Height - impeller center	in. mm	16 1/2" 419
Impeller RPM		540 RPM
Required RPM for the tractor PTO		540 RPM • Opt. 1000 RPM
Number of auger		1 open flight, double ribboned, serrated auger
Main auger diameter	in. mm	25" 635
Bearing / ductile iron casting	in. mm	1 1/4" 32
Drive chain - main auger		60
Number of shear bolts		1 for impeller + 1 for auger
Speed reducer inverter (<i>option</i>)		Your choice : PRC-6501-1, PR-7502-1, PR-7502-2
Included PTO (optional)		T50 (T60)
Optional lateral blades		High quality steel
Scraper blade		3/8" x 3 1/2" reversible
- <i>Option semi-industrial, Hardox 450</i>		SIT1-154
- <i>Option Tivar</i>		TV-154
- <i>Option stainless steel</i>		SST-154
Adjustable skid shoes	Quick adjust	High quality steel
- <i>Option Hardox 450</i>		PHD-4872
- <i>Option stainless steel</i>		PST-4872
Chute	Semi-industrial	PC3C-GR1.5
Chute rotation	With hydraulic motor	MLH-250-R
Chute rotation maximum angle	Hydraulic motor rotation	270° to 345° adjustable
Antifriction for chute		Ring
Chute deflector	Hydraulic cylinder	25TR04
- <i>Option manual</i>		T-4864
Color (including primer)		Pronovost red ¹
Storage support		✓
Weight including PSIG chute	lbs kg	1013 460

¹ Choice of color available in option.

Design and specifications subject to change without notice.

CHARACTERISTICS AND OPTIONS - PUBLIC WORKS CATEGORY

CHUTE



PSIR INCLUDED (RED)

- ✓ Semi-industrial Gr.I

PSIG INCLUDED (RED)

- ✓ Semi-industrial Gr.III

PSIG INCLUDED (YELLOW)

- ✓ Sidewalk - P-542
- ✓ Sidewalk - P-254



PC3C-GR1.5 (RED)

- ✓ Sidewalk - P-54126-GV



PCG-92104 (RED)

- ✓ Semi-industrial Gr.III

PCG-IND (YELLOW)

- ✓ Industrial - Full flight auger

PCG-7486 (YELLOW)

- ✓ Sidewalk - P-254



PRP-IND (YELLOW)

- ✓ Industrial - Full flight auger



PRP-92104(-2) (RED)

- ✓ Semi-industrial Gr.III

PRP-7486(-2) (YELLOW)

- ✓ Sidewalk - P-254



PCT-92104 (RED)

- ✓ Semi-industrial Gr.III

PCTC-IND (YELLOW)

- ✓ Industrial - Open flight auger
- ✓ Industrial - Full flight auger

PCT-7486-HDB (YELLOW)

- ✓ Sidewalk - P-254



PCTC-INDR (YELLOW)

- ✓ Semi-industrial Gr.III
- ✓ Industrial - Open flight auger
- ✓ Industrial - Full flight auger

SCRAPER BLADE

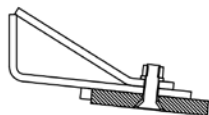

SIT1 (LONG LIFE)

- ✓ Semi-industrial Gr.III
- ✓ Sidewalk - P-254

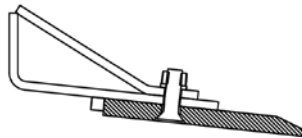

T1 (EXTRA-LONG LIFE)

- ✓ Semi-industrial Gr.III
- ✓ Sidewalk - P-254

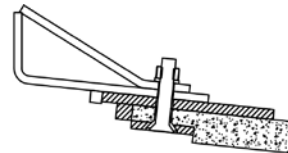

TV (NON-AGRESSVE AND RUST PROOF)

- ✓ Sidewalk - P-542

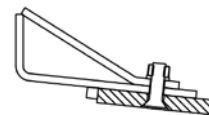

SST (RUST PROOF)

- ✓ Semi-industrial Gr.III
- ✓ Sidewalk - P-542

CHARACTERISTICS AND OPTIONS - PUBLIC WORKS CATEGORY

SKID SHOES



PHD (YELLOW)

- ✓ Semi-industrial Gr.III
- ✓ Sidewalk - P-254



PSHD (RED)

- ✓ Semi-industrial Gr.III



PST (BLUE)

- ✓ Semi-industrial Gr.III
- ✓ Sidewalk - P-542

LATERAL BLADES

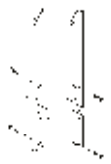

CL

- ✓ Industrial - Open flight auger
- ✓ Industrial - Full flight auger
- ✓ Sidewalk - P-542

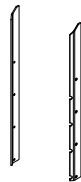

CL

- ✓ Semi-industrial Gr.III

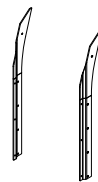

CL

- ✓ Semi-industrial Gr.III

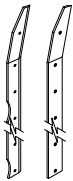

CL

- ✓ Industrial - Open flight auger
- ✓ Industrial - Full flight auger

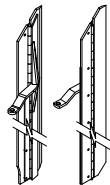

CLH

- ✓ Industrial - Open flight auger
- ✓ Industrial - Full flight auger
- ✓ Sidewalk - P-542

WORKING LIGHTS FOR CHUTE

PKL-IND92104

- ✓ Semi-industrial Gr.III
- ✓ Industrial - Open flight auger
- ✓ Industrial - Full flight auger

PKL-IND7486

- ✓ Sidewalk - P-254

PKL-INDR

- ✓ Semi-industrial Gr.III
- ✓ Industrial - Open flight auger
- ✓ Industrial - Full flight auger



PTO



Standard

- ✓ Sidewalk - P-254



Multilobe

- ✓ Semi-industrial Gr.III
- ✓ Industrial - Open flight auger

LATERAL SKID SHOE



PHCT-PGV

- ✓ Industrial - Open flight auger

OIL COOLER



RH250-PGV-1022

- ✓ Industrial - Open flight auger

CHARACTERISTICS AND OPTIONS - PUBLIC WORKS CATEGORY

SPEED REDUCER

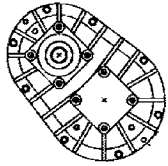

PR2G-250-2 OR 2.5 OR 3

- ✓ Industrial - Open flight auger



PR3G200-2

- ✓ Semi-industrial Gr.III
- ✓ Industrial - Open flight auger
- ✓ Industrial - Full flight auger



PR3G250-2.5

- ✓ Industrial - Open flight auger
- ✓ Industrial - Full flight auger



PR3G275-3

- ✓ Industrial - Open flight auger with 37" drum



PRH-30M-2 OR 2.5

- ✓ Semi-industrial Gr.III
- ✓ Industrial - Full flight auger



PRH-25M-2 OR 2.5

- ✓ Semi-industrial Gr.III
- ✓ Industrial - Full flight auger

KIT OF DIVERTERS



KVD

- ✓ Semi-industrial Gr.III
- ✓ Industrial - Open flight auger
- ✓ Industrial - Full flight auger



HYDRAULIC DRIVEN SNOWBLOWERS



Boasting a range of more than 80 PTO driven snowblower models, we have developed a high performance hydraulic drive system that allows us to combine the best snowblower for every type of utility vehicle and wheel loader. The hydraulic power range covers 18 to 60 GPM and up to 5800 psi.

OUR HYDRAULIC DRIVEN SNOWBLOWERS TYPICALLY HAVE THE FOLLOWING CHARACTERISTICS :

- Open and serrated auger
- Quick adjust skid shoes
- Hydraulic chute rotation and deflector
- High performance with piston motor

.... AND PRESENT THE FOLLOWING OPTIONS :

- Drum rotation (TRC)
- Hydraulic lateral blades

WHEEL LOADERS AND UTILITY VEHICLES

Over the years, our snowblowers have been mounted on a variety of loaders and utility vehicles from different major manufacturers, such as :

- | | |
|---------------|-----------------|
| ● BOBCAT | ● NEW HOLLAND |
| ● CATERPILLAR | ● PRINOTH |
| ● JCB | ● VOLVO |
| ● JOHN DEERE | ● VTC |
| ● KUBOTA | ● WACKER NEUSON |
| ● MULTIHOOG | ● WILLE |

The **hydraulic oil flow** at a **specific pressure** will guide us in the choice of the snowblower.

CONTACT THE PRONOVOST TEAM TO OBTAIN A QUOTE FOR YOUR SPECIFIC REQUIREMENTS.



P-540 & WACKER NEUSON WL32



PGS-800 & MULTIHOOG MH90



P-112234TRC & CATERPILLAR 938 K



HARDY SAND AND SALT SPREADER



MODEL	DESCRIPTION	SUGGESTED RETAIL
1000-2681JP	54" Sand and salt spreader *	5,438. \$
1000-3821JP	74" Sand and salt spreader *	5,864. \$
1000-3861JP	86" Sand and salt spreader *	6,227. \$

* Without lid, blade and brackets, including hydraulic motor and hoses to the top of the frame.

OPTION	DESCRIPTION	SUGGESTED RETAIL
CHOICE OF AVAILABLE BRACKETS		
1000-3941	Hardy quick attach for loaders Serie 5 (25 & 35) and XTREMPRO (40 & 50).	629. \$
1000-3931	Hardy standard quick attach (Larger model than 1000-3941).	902. \$
1000-3911	Euro quick attach (agricultural vehicle).	669. \$
1000-3921	Skid Steer quick attach.	653. \$
1000-4661	Stationary 3 point hitch cat. 1 for 54" spreader.	1,117. \$
1000-4671	Stationary 3 point hitch cat. 1 & 2 for 74" and 86" spreaders.	1,580. \$
1000-3891	Hydraulic tilt 3 point hitch cat. 1 for 54" spreaders. *	2,598. \$
1000-1561	Hydraulic tilt 3 point hitch cat. 1 & 2 for 74" and 86" spreaders. *	2,658. \$
110-80601	Euro quick attach (industrial vehicle).	827. \$
110-80851	Iso quick attach (Volvo compatible).	1,334. \$
* Including 2 cylinders.		
HOSE KIT		
PKB-HGQ54	Hose kit hydraulic 3-point tilt hitch for 54" spreader.	375. \$
PKB-HGQ7486	Hose kit hydraulic 3-point tilt hitch for 74" and 86" spreaders.	383. \$

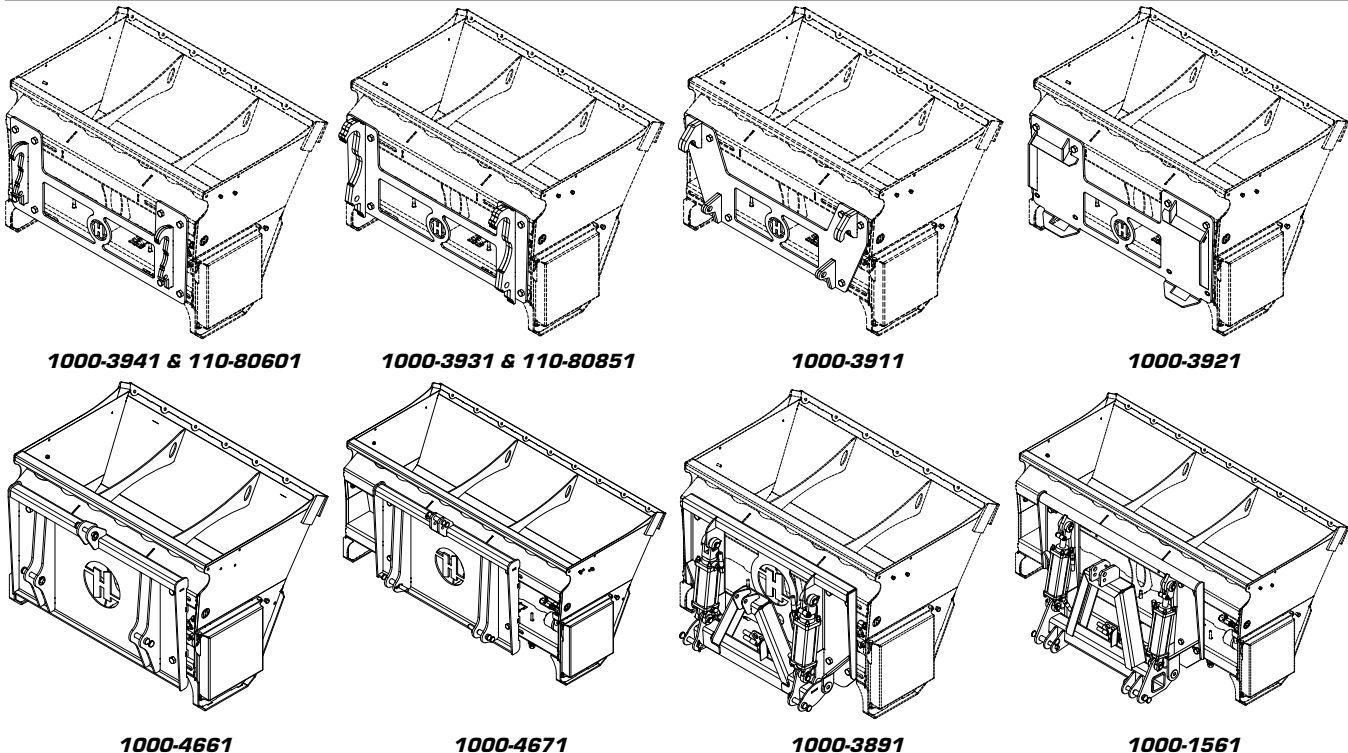



BOLT ON BLADE			
	54" Spreader	74" Spreader	86" Spreader
Bolt on blade	1000-3071	1000-3851	1000-3141
	440. \$	489. \$	541. \$
LID			
Steel lid	1000-3831	1000-3841	1000-3151
	678. \$	867. \$	930. \$

INNOVATION



- ✓ **Hydraulic motors selected to match the tractor's hydraulic flow.**
- ✓ Fewer moving parts. With our new design, only one UHMW dispenser flap is required. This one is reversible.
- ✓ Bearing protection.
- ✓ Automatic dispenser adjustment system, protected by spring.
- ✓ Flared side. Allows an easier filling and a greater load capacity. The flared opening also allows a better protection of the lateral mechanism.
- ✓ Enclosed chain box. Our hydraulic drive & binder assembly with its chain box cover prevents material from entering the mechanism.
- ✓ Recommended with materials such as salt, non-compact dry sand or 1/4" net crushed stone.
- ✓ Storage support (always store the bucket empty).



Hydraulic tilt 3 point hitch for autonomous loading (including 2 cylinders).



Sand spreading pattern.

SPECIFICATIONS

MODEL	54"	74"	86"
Overall width with steel lid	53 3/4"	75 1/2"	87 3/4"
Overall width	52 3/4"	74"	86"
Spreading width	47 1/2"	69"	80"
Height	35 1/4"	35 1/4"	41 1/4"
Depth without attach	33 1/4"	33 1/4"	36 1/2"
Capacity	cubic yard <i>cubic meter</i>		
	,50 v ³ 0,39 m ³	,70 v ³ 0,54 m ³	1,15 v ³ 0,88 m ³
Weight	lbs <i>kg</i>		
	488 lbs 222 <i>kg</i>	639 lbs 290 <i>kg</i>	781 lbs 355 <i>kg</i>
Weight filled with sand (approx.)	lbs <i>kg</i>		
	1742 lbs 790 <i>kg</i>	2458 lbs 1115 <i>kg</i>	3638 lbs 1650 <i>kg</i>
Hydraulic drive motor	MLH-125	MLH-250	MLH-315
Recommended hydraulic	8 GPM	15 GPM +	20 GPM +

Design and specifications subject to change without notice.



HYDRAULIC WHEELS FOR SNOWBLOWERS



Hydraulic wheels allow the use of the snowblower at a constant height from the ground without scraping it.

Practical to avoid blowing gravel.

Permits snowblowing on a grassy surface while avoiding direct contact of the blade with the ground.

Price on request.

Available only on a new snowblower made in production.

**CALL TO INQUIRE ABOUT THE COST
OF A KIT CORRESPONDING
TO YOUR REQUIREMENTS.
TEL.: 418 365-7551**





ICE SCRAPER BLADE FOR SNOWBLOWERS

NEW !

The ice scraper blade is installed under the snowblower, easily and requires no tool. Scrape icy surfaces to create a grooved finish that increases grip.

Its design requires no additional oil outlet or any modification to the snowblower. When required, the ice scraper blade must be assembled to the snowblower and then disassembled after use.

Price on request.

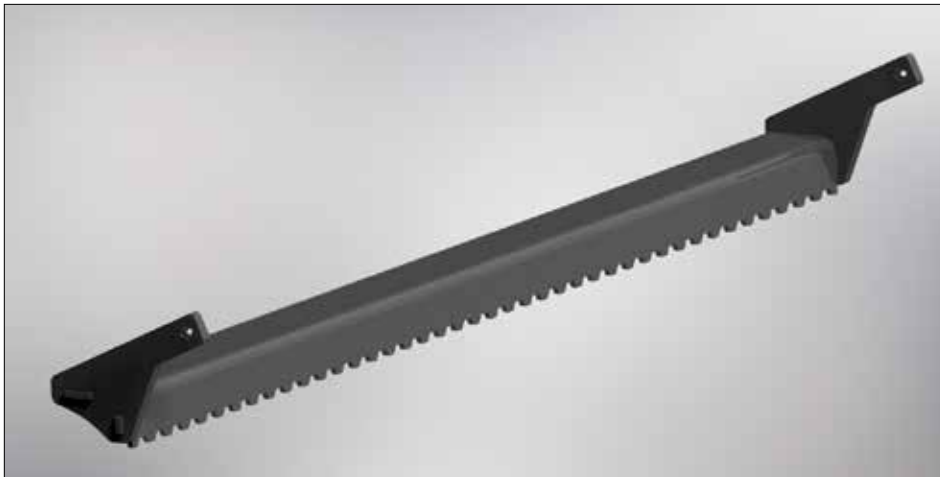

**CALL TO INQUIRE
ABOUT THE COST
OF A KIT CORRESPONDING
TO YOUR REQUIREMENTS.**

TEL.: 418 365-7551

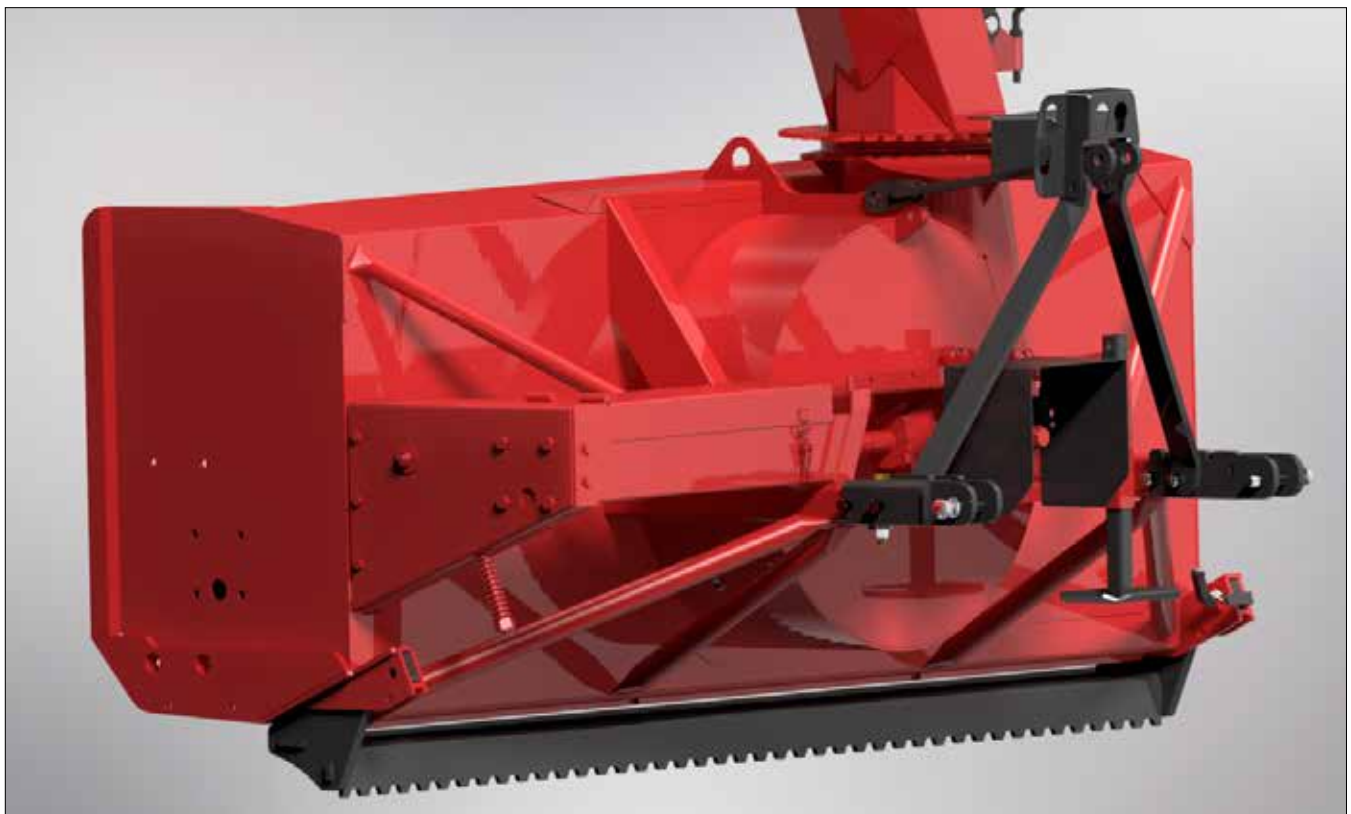



HYDRAULIC FLOTATION SKI FOR SNOWBLOWERS

NEW !

The hydraulic flotation ski allows you to use the snowblower at a constant height above the ground, without scraping it.

Allows you to compact a hard and uniform snow bottom in the gravel entrances while preventing gravel from entering the snowblower. Allows you to blow on a grassy surface while avoiding contact of the snowblowers blade with the ground.

Price on request.

**CALL TO INQUIRE
ABOUT THE COST
OF A KIT CORRESPONDING
TO YOUR REQUIREMENTS.**

TEL.: 418 365-7551



EVOLUTION OF WEIGHT CHANGES FOR PXPL SNOWBLOWERS

Year	Model	Weight ¹	Weight ¹ reduction from 1999	Weight ¹ reduction from 2003
1999 to 2002	P-860 + XP-860 blade	2107 lbs (956 kg)	-	-
	P-920 + XP-920 blade	2857 lbs (1296 kg)	-	-
2003	PXP-860	1917 lbs (870 kg)	-190 lbs (86 kg)	-
	PXP-920	2557 lbs (1160 kg)	-300 lbs (136 kg)	-
2004	PXPL-86	1822 lbs (826 kg)	-285 lbs (129 kg)	-95 lbs (43 kg)
	PXPL-92	2059 lbs (934 kg)	-798 lbs (362 kg)	-498 lbs (226 kg)
2017	PXPL-86	1889 lbs (857 kg)	-218 lbs (99 kg)	-28 lbs (13 kg)
	PXPL-92	2151 lbs (976 kg)	-706 lbs (320 kg)	-406 lbs (184 kg)

¹Including semi-industrial chute, PTO and hydraulic motor.

Specified weights are for reference only. They may vary depending on options and manufacturing dates.

SCRAPER BLADE FOR PRONOVOST SNOWBLOWERS GROUP I, II AND III

CHOICE OF SCRAPER BLADE



BENEFIT

ECONOMICAL



LONG LIFE



WITHOUT RUST TRACE



ECONOMICAL



LONG LIFE

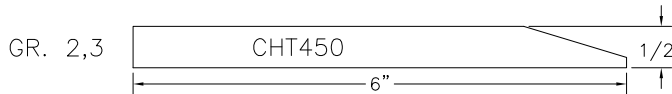

EXTRA LONG LIFE



WITHOUT RUST TRACE

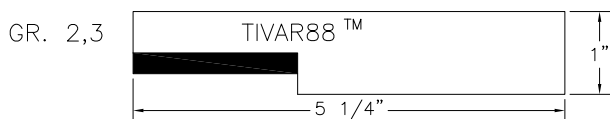

NON-AGRESSIVE AND WITHOUT RUST TRACE

SKID SHOES



Black
Standard steel
Economical

Blue
Stainless steel
Rust proof

Yellow
Hardox 450
Long life



Red
Hardox 600
Extra long life and less aggressive than carbide

190-11011

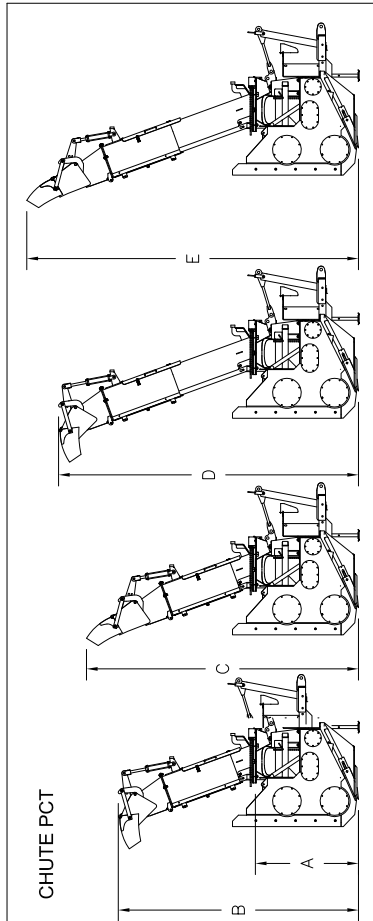

CHUTE PCT

MODELE	A	B	C	D	E	MODELE CHUTE
P-800	38"	107"	124"	138"	156"	PCT-7486
P-860,P-862,P-860-92	40"	109"	126"	140"	158"	PCT-7486
P-860TRC,P-862TRC,P-860TRC-92	43"	112"	129"	143"	161"	PCT-7486
P-920,P-920-98	41"	110"	127"	141"	159"	PCT-7486
P-920TRC,P-920TRC-98	46"	115"	132"	146"	164"	PCT-7486
P-922,P-981,34	44"	113"	130"	144"	162"	PCT-7486
P-922TRC,P-981,34TRC	49"	118"	135"	149"	167"	PCT-7486
P-981,34-GV	44"	113"	130"	144"	162"	PCT-7486
P-981,34TRC-GV	49"	118"	135"	149"	167"	PCT-7486
P-980,P-1020,P-1040	47"	116"	132"	146"	162"	PCT-92104
P-980TRC,P-1020TRC,P-1040TRC	49"	118"	134"	148"	164"	PCT-92104
P-982TRC	52"	121"	137"	151"	167"	PCT-IND
P-1022TRC	53"	122"	138"	152"	168"	PCT-IND
PGS-1020TRC,PGS-1080TRC	50"	119"	135"	149"	165"	PCT-92104

P-1022TRC-200 AVEC CHUTE PCT-IND REPRESENTÉ

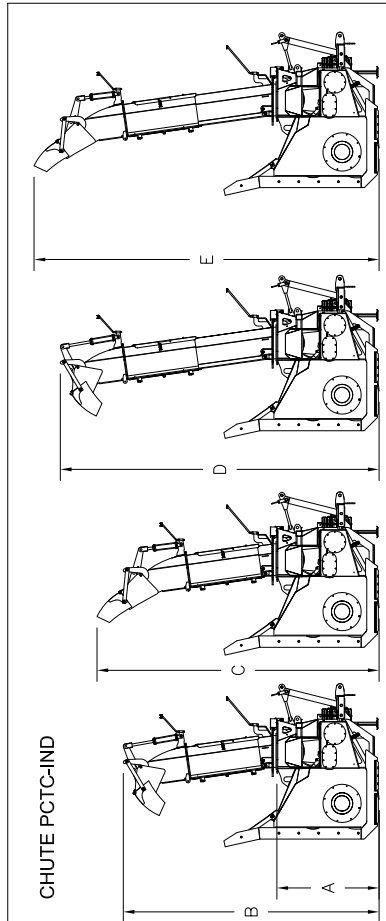

CHUTE PCTC-IND

MODELE	A	B	C	D	E	MODELE CHUTE
PGV-1021TRC	52"	129"	143"	161"	174"	PCTC-IND
PGV-1022TRC,PGV-1202TRC	55"	132"	146"	164"	177"	PCTC-IND
PGV-1201,37TRC	55"	132"	146"	164"	177"	PCTC-IND

PGV-1021TRC-150 AVEC CHUTE PCTC-IND REPRESENTÉ

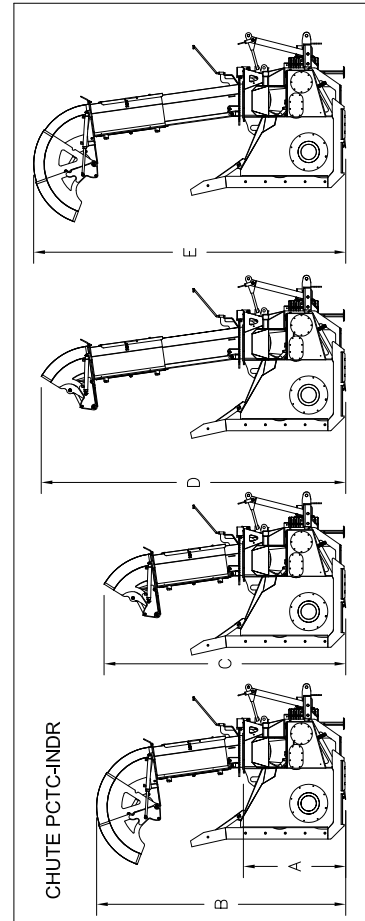

CHUTE PCTC-INDR

MODELE	A	B	C	D	E	MODELE CHUTE
P-890,P-1020,P-1040	47"	121"	117"	149"	153"	PCTC-INDR
P-890TRC,P-1020TRC,P-1040TRC	49"	123"	119"	151"	155"	PCTC-INDR
P-982TRC	53"	127"	123"	155"	159"	PCTC-INDR
P-1022TRC	52"	126"	122"	154"	158"	PCTC-INDR
PGS-1020TRC,PGS-1080TRC	50"	124"	120"	152"	156"	PCTC-INDR
PGV-1021TRC	52"	126"	122"	154"	158"	PCTC-INDR
PGV-1022TRC,PGV-1202TRC	55"	129"	125"	157"	161"	PCTC-INDR
PGV-1201,37TRC	55"	129"	125"	157"	161"	PCTC-INDR

PGV-1021TRC-150 AVEC CHUTE PCTC-INDR REPRESENTÉ

PUMA		
PUMA-48		3 216 \$
6545	P.T.O. shaft	324 \$
TLY-04	Manual deflector	35 \$
MD-4872	Manual chute rotation kit	200 \$
CPUSI-4872	Chute with 2 hinged deflectors	503 \$
Puma-48 RMAN	Total:	4 278 \$
<hr/>		
PUMA-48		3 216 \$
6545	P.T.O. shaft	324 \$
TLY-04	Manual deflector	35 \$
HRD-4872	Chute rotation kit for cylinder	405 \$
25TR04	Chute rotation cylinder	161 \$
CPUSI-4872	Chute with 2 hinged deflectors	503 \$
Puma-48 RCYL	Total:	4 644 \$
<hr/>		
PUMA-48		3 216 \$
6545	P.T.O. shaft	324 \$
TLY-04	Manual deflector	35 \$
HMD-4872	Chute rotation kit for hydraulic motor	309 \$
MLH-125	Chute rotation motor	526 \$
CPUSI-4872	Chute with 2 hinged deflectors	503 \$
Total:		4 913 \$
<hr/>		
PUMA-48		3 216 \$
6545	P.T.O. shaft	324 \$
TLY-04	Manual deflector	35 \$
ERD-4872	Electric chute rotation kit	756 \$
CPUSI-4872	Chute with 2 hinged deflectors	503 \$
Puma-48 RELE	Total:	4 834 \$
<hr/>		
PUMA-54		3 305 \$
6545	P.T.O. shaft	324 \$
TLY-04	Manual deflector	35 \$
MD-4872	Manual chute rotation kit	200 \$
CPUSI-4872	Chute with 2 hinged deflectors	503 \$
Puma-54 RMAN	Total:	4 367 \$
<hr/>		
PUMA-54		3 305 \$
6545	P.T.O. shaft	324 \$
TLY-04	Manual deflector	35 \$
HRD-4872	Chute rotation kit for cylinder	405 \$
25TR04	Chute rotation cylinder	161 \$
CPUSI-4872	Chute with 2 hinged deflectors	503 \$
Puma-54 RCYL	Total:	4 733 \$
<hr/>		
PUMA-54		3 305 \$
6545	P.T.O. shaft	324 \$
TLY-04	Manual deflector	35 \$
HMD-4872	Chute rotation kit for hydraulic motor	309 \$
MLH-125	Chute rotation motor	526 \$
CPUSI-4872	Chute with 2 hinged deflectors	503 \$
Puma-54 RMOT	Total:	5 002 \$
<hr/>		
PUMA-54		3 305 \$
6545	P.T.O. shaft	324 \$
TLY-04	Manual deflector	35 \$
ERD-4872	Electric chute rotation kit	756 \$
CPUSI-4872	Chute with 2 hinged deflectors	503 \$
Puma-54 RELE	Total:	4 923 \$
<hr/>		
PUMA-64		3 480 \$
6408	P.T.O. shaft	340 \$
TLY-04	Manual deflector	35 \$
MD-4872	Manual chute rotation kit	200 \$
CPUSI-4872	Chute with 2 hinged deflectors	503 \$
Puma-64 RMAN	Total:	4 558 \$

PUMA-64		3 480 \$
6408	P.T.O. shaft	340 \$
TLY-04	Manual deflector	35 \$
HRD-4872	Chute rotation kit for cylinder	405 \$
25TR04	Chute rotation cylinder	161 \$
CPUSI-4872	Chute with 2 hinged deflectors	503 \$
Puma-64 RCYL	Total:	4 924 \$
<hr/>		
PUMA-64		3 480 \$
6408	P.T.O. shaft	340 \$
TLY-04	Manual deflector	35 \$
HMD-4872	Chute rotation kit for hydraulic motor	309 \$
MLH-125	Chute rotation motor	526 \$
CPUSI-4872	Chute with 2 hinged deflectors	503 \$
Puma-64 RMOT	Total:	5 193 \$
<hr/>		
PUMA-64		3 480 \$
6408	P.T.O. shaft	340 \$
TLY-04	Manual deflector	35 \$
ERD-4872	Electric chute rotation kit	756 \$
CPUSI-4872	Chute with 2 hinged deflectors	503 \$
Puma-64 RELE	Total:	5 114 \$
<hr/>		
PUMA-72		3 640 \$
6248	P.T.O. shaft	422 \$
TLY-04	Manual deflector	35 \$
MD-4872	Manual chute rotation kit	200,00
CPUSI-4872	Chute with 2 hinged deflectors	503 \$
Puma-72 RMAN	Total:	4 800 \$
<hr/>		
PUMA-72		3 640 \$
6248	P.T.O. shaft	422 \$
TLY-04	Manual deflector	35 \$
HRD-4872	Chute rotation kit for cylinder	405 \$
25TR04	Chute rotation cylinder	161 \$
CPUSI-4872	Chute with 2 hinged deflectors	503 \$
Puma-72 RCYL	Total:	5 166 \$
<hr/>		
PUMA-72		3 640 \$
6248	P.T.O. shaft	422 \$
TLY-04	Manual deflector	35 \$
HMD-4872	Chute rotation kit for hydraulic motor	309 \$
MLH-125	Chute rotation motor	526 \$
CPUSI-4872	Chute with 2 hinged deflectors	503 \$
Puma-72 RMOT	Total:	5 435 \$
<hr/>		
PUMA-72		3 640 \$
6248	P.T.O. shaft	422 \$
TLY-04	Manual deflector	35 \$
ERD-4872	Electric chute rotation kit	756 \$
CPUSI-4872	Chute with 2 hinged deflectors	503 \$
Puma-72 RELE	Total:	5 356 \$
<hr/>		
PUMA-76		4 657 \$
6248	P.T.O. shaft	422 \$
TLY-08	Manual deflector	35 \$
MD-74	Manual chute rotation kit	246 \$
CPUSI-7480	Chute with 2 hinged deflectors	765 \$
Puma-76 RMAN	Total:	6 125 \$

PUMA-76		4 657 \$
6248	P.T.O. shaft	422 \$
TLY-04	Manual deflector	35 \$
HRD-74	Chute rotation kit for cylinder	524 \$
25TR08	Chute rotation cylinder	164 \$
CPUSI-7480	Chute with 2 hinged deflectors	765 \$
Puma-76 RCYL	Total:	6 567 \$

PUMA-76		4 657 \$
6248	P.T.O. shaft	422 \$
TLY-04	Manual deflector	35 \$
HMD-74	Chute rotation kit for hydraulic motor	327 \$
MLH-250-R	Chute rotation motor	591 \$
CPUSI-7480	Chute with 2 hinged deflectors	765 \$
Puma-76 RMOT	Total:	6 797 \$

PUMA-80		4 933 \$
6248	P.T.O. shaft	422 \$
TLY-04	Manual deflector	35 \$
MD-74	Manual chute rotation kit	246 \$
CPUSI-7480	Chute with 2 hinged deflectors	765 \$
Puma-80 RMAN	Total:	6 401 \$

PUMA-80		4 933 \$
6248	P.T.O. shaft	422 \$
TLY-04	Manual deflector	35 \$
HRD-74	Chute rotation kit for cylinder	524 \$
25TR08	Chute rotation cylinder	164 \$
CPUSI-7480	Chute with 2 hinged deflectors	765 \$
Puma-80 RCYL	Total:	6 843 \$

PUMA-80		4 933 \$
6248	P.T.O. shaft	422 \$
TLY-04	Manual deflector	35 \$
HMD-74	Chute rotation kit for hydraulic motor	327 \$
MLH-250-R	Chute rotation motor	591 \$
CPUSI-7480	Chute with 2 hinged deflectors	765 \$
Puma-80 RMOT	Total:	7 073 \$

PUMA-84		6 143 \$
8114	P.T.O. shaft	485 \$
TLY-08	Manual deflector	45 \$
MD-8494	Manual chute rotation kit	258 \$
CPUSI-8496	Chute with 2 hinged deflectors	814 \$
Puma-84 RMAN	Total:	7 745 \$

PUMA-84		6 143 \$
8114	P.T.O. shaft	485 \$
TLY-08	Manual deflector	45 \$
HRD-8494	Chute rotation kit for cylinder	566 \$
25TR08	Chute rotation cylinder	164 \$
CPUSI-8496	Chute with 2 hinged deflectors	814 \$
Puma-84 RCYL	Total:	8 217 \$

PUMA-84		6 143 \$
8114	P.T.O. shaft	485 \$
TLY-08	Manual deflector	45 \$
HMD-8494	Chute rotation kit for hydraulic motor	365 \$
MLH-315-R	Chute rotation motor	604 \$
CPUSI-8496	Chute with 2 hinged deflectors	814 \$
Puma-84 RMOT	Total:	8 456 \$

PUMA-94		6 537 \$
8202	P.T.O. shaft	541 \$
TLY-08	Manual deflector	45 \$
MD-8494	Manual chute rotation kit	258 \$
CPUSI-8496	Chute with 2 hinged deflectors	814 \$
Puma-94 RMAN	Total:	8 195 \$

PUMA-94		6 537 \$
8202	P.T.O. shaft	541 \$
TLY-08	Manual deflector	45 \$
HRD-8494	Chute rotation kit for cylinder	566 \$
25TR08	Chute rotation cylinder	164 \$
CPUSI-8496	Chute with 2 hinged deflectors	814 \$
Puma-94 RCYL	Total:	8 667 \$

PUMA-94		6 537 \$
8202	P.T.O. shaft	541 \$
TLY-08	Manual deflector	45 \$
HMD-8494	Chute rotation kit for hydraulic motor	365 \$
MLH-315-R	Chute rotation motor	604 \$
CPUSI-8496	Chute with 2 hinged deflectors	814 \$
Puma-94 RMOT	Total:	8 906 \$

PUMA-96		8 299 \$
9225	P.T.O. shaft	784 \$
TLY-08	Manual deflector	45 \$
MD-8494	Manual chute rotation kit	258 \$
CPUSI-8496	Chute with 2 hinged deflectors	814 \$
Puma-96 RMAN	Total:	10 200 \$

PUMA-96		8 299 \$
9225	P.T.O. shaft	784 \$
TLY-08	Manual deflector	45 \$
HRD-8494	Chute rotation kit for cylinder	566 \$
25TR08	Chute rotation cylinder	164 \$
CPUSI-8496	Chute with 2 hinged deflectors	814 \$
Puma-96 RCYL	Total:	10 672 \$

PUMA-96		8 299 \$
9225	P.T.O. shaft	784 \$
TLY-08	Manual deflector	45 \$
HMD-8494	Chute rotation kit for hydraulic motor	365 \$
MLH-315-R	Chute rotation motor	604 \$
CPUSI-8496	Chute with 2 hinged deflectors	814 \$
Puma-96 RMOT	Total:	10 911 \$

PUMA IV

PUMA-64-IV		5 394 \$
400-00341	P.T.O. shaft	530 \$
CPUSI-4872-IV	Chute with 2 hinged deflectors	503 \$
TLY-04	Manual deflector	35 \$
HMD-4872	Chute rotation kit for hydraulic motor	309 \$
MLH-125	Chute rotation motor	526 \$
Puma-64-IV RMOT	Total:	7 297 \$

PUMA-64-IV		5 394 \$
400-00341	P.T.O. shaft	530 \$
CPUSI-4872-IV	Chute with 2 hinged deflectors	503 \$
TLY-04	Manual deflector	35 \$
ERD-4872	Electric chute rotation kit	756 \$
Puma-64-IV RELE	Total:	7 218 \$

PUMA-72-IV		5 491 \$
400-00341	P.T.O. shaft	530 \$
CPUSI-4872-IV	Chute with 2 hinged deflectors	503 \$
TLY-04	Manual deflector	35 \$
HMD-4872	Chute rotation kit for hydraulic motor	309 \$
MLH-125	Chute rotation motor	526 \$
Puma-72-IV RMOT	Total:	7 394 \$

PUMA-72-IV		5 491 \$
400-00341	P.T.O. shaft	530 \$
CPUSI-4872-IV	Chute with 2 hinged deflectors	503 \$
TLY-04	Manual deflector	35 \$
ERD-4872	Electric chute rotation kit	756 \$
Puma-72-IV RELE	Total:	7 315 \$

PUMA-74-IV		7 349 \$
400-00418	P.T.O. shaft	613 \$
CPUSI-7480-IV	Chute with 2 hinged deflectors	765 \$
TLY-04	Manual deflector	35 \$
MLH-250-R	Chute rotation motor	591 \$
Puma-74-IV RMOT	Total:	9 353 \$

PUMA-80-IV		7 529 \$
400-00418	P.T.O. shaft	613 \$
CPUSI-7480-IV	Chute with 2 hinged deflectors	765 \$
TLY-04	Manual deflector	35 \$
MLH-250-R	Chute rotation motor	591 \$
Puma-80-IV RMOT	Total:	9 533 \$

LYNX		
LYNX-52		2 850 \$
6545	P.T.O. shaft	324 \$
TLY-04	Manual deflector	35 \$
LC-5270	Lynx chute	303 \$
MD-4872	Manual chute rotation kit	200 \$
Lynx-52 RMAN	Total:	3 712 \$

LYNX-52		2 850 \$
6545	P.T.O. shaft	324 \$
TLY-04	Manual deflector	35 \$
LC-5270	Lynx chute	303 \$
HRD-4872	Chute rotation kit for cylinder	405 \$
25TR04	Chute rotation cylinder	161 \$
LYNX-52 RCYL	Total:	4 078 \$

LYNX-52		2 850 \$
6545	P.T.O. shaft	324 \$
TLY-04	Manual deflector	35 \$
LC-5270	Lynx chute	303 \$
ERD-4872	Electric chute rotation kit	756 \$
LYNX-52 RELE	Total:	4 268 \$

LYNX-62		2 893 \$
6545	P.T.O. shaft	324 \$
TLY-04	Manual deflector	35 \$
LC-5270	Lynx chute	303 \$
MD-4872	Manual chute rotation kit	200 \$
Lynx-62 RMAN	Total:	3 755 \$

LYNX-62		2 893 \$
6545	P.T.O. shaft	324 \$
TLY-04	Manual deflector	35 \$
LC-5270	Lynx chute	303 \$
HRD-4872	Chute rotation kit for cylinder	405 \$
25TR04	Chute rotation cylinder	161 \$
LYNX-62 RCYL	Total:	4 121 \$

LYNX-62		2 893 \$
6545	P.T.O. shaft	324 \$
TLY-04	Manual deflector	35 \$
LC-5270	Lynx chute	303 \$
ERD-4872	Electric chute rotation kit	756 \$
LYNX-62 RELE	Total:	4 311 \$

LYNX-70		2 925 \$
6545	P.T.O. shaft	324 \$
TLY-04	Manual deflector	35 \$
LC-5270	Lynx chute	303 \$
MD-4872	Manual chute rotation kit	200 \$
LYNX-70 RMAN	Total:	3 787 \$

LYNX-70		2 925 \$
6545	P.T.O. shaft	324 \$
TLY-04	Manual deflector	35 \$
LC-5270	Lynx chute	303 \$
HRD-4872	Chute rotation kit for cylinder	405 \$
25TR04	Chute rotation cylinder	161 \$
LYNX-70 RCYL	Total:	4 153 \$

LYNX-70		2 925 \$
6545	P.T.O. shaft	324 \$
TLY-04	Manual deflector	35 \$
LC-5270	Lynx chute	303 \$
ERD-4872	Electric chute rotation kit	756 \$
LYNX-70 RELE	Total:	4 343 \$

LYNX-74		4 506 \$
6248	P.T.O. shaft	422 \$
TLY-08	Manual deflector	45 \$
LC-74	Lynx chute	352 \$
MD-74	Manual chute rotation kit	246 \$
LYNX-74 RMAN	Total:	5 571 \$

LYNX-74		4 506 \$
6248	P.T.O. shaft	422 \$
TLY-08	Manual deflector	45 \$
LC-74	Lynx chute	352 \$
HRD-74	Chute rotation kit for cylinder	524 \$
25TR08	Chute rotation cylinder	164 \$
LYNX-74 RCYL	Total:	6 013 \$

GROUP I		
P-540		6 291 \$
6408	P.T.O. shaft	340 \$
PSIG-5472	Semi-industrial chute	963 \$
MLH-125	Chute rotation motor	526 \$
25TR04	Deflector cylinder	161 \$
TSB-4864	Hose support	60 \$
P-540 COMBO	Total:	8 341 \$

P-620		6 369 \$
6408	P.T.O. shaft	340 \$
PSIG-5472	Semi-industrial chute	963 \$
MLH-125	Chute rotation motor	526 \$
25TR04	Deflector cylinder	161 \$
TSB-4864	Hose support	60 \$
P-620 COMBO	Total:	8 419 \$

P-680		7 461 \$
6248	P.T.O. shaft	422 \$
PSIG-5472	Semi-industrial chute	963 \$
MLH-250-R	Chute rotation motor	591 \$
25TR04	Deflector cylinder	161 \$
TSB-4864	Hose support	60 \$
P-680 COMBO	Total:	9 658 \$

P-720		7 493 \$
8114	P.T.O. shaft	485 \$
PSIG-5472	Semi-industrial chute	963 \$
MLH-250-R	Chute rotation motor	591 \$
25TR04	Deflector cylinder	161 \$
TSB-4864	Hose support	60 \$
P-720 COMBO	Total:	9 753 \$

P-720TRC		8 575 \$
8114	P.T.O. shaft	485 \$
PSIG-5472	Semi-industrial chute	963 \$
MLH-250-R	Chute rotation motor	591 \$
25TR04	Deflector cylinder	161 \$
TSB-4864	Hose support	60 \$
MLH-100	Motor for drum rotation	498 \$
P-720TRC COMBO	Total:	11 333 \$

P-720-74		7 878 \$
8114	P.T.O. shaft	485 \$
PSIG-5472	Semi-industrial chute	963 \$
MLH-250-R	Chute rotation motor	591 \$
25TR04	Deflector cylinder	161 \$
TSB-4864	Hose support	60 \$
P-720-74 COMBO	Total:	10 138 \$

P-720TRC-74		9 005 \$
8114	P.T.O. shaft	485 \$
PSIG-5472	Semi-industrial chute	963 \$
MLH-250-R	Chute rotation motor	591 \$
25TR04	Deflector cylinder	161 \$
TSB-4864	Hose support	60 \$
MLH-100	Motor for drum rotation	498 \$
P-720TRC-74 COMBO	Total:	11 763 \$

P-720-80		7 944 \$
8114	P.T.O. shaft	485 \$
PSIG-5472	Semi-industrial chute	963 \$
MLH-250-R	Chute rotation motor	591 \$
25TR04	Deflector cylinder	161 \$
TSB-4864	Hose support	60 \$
P-720-80 COMBO	Total:	10 204 \$

P-720TRC-80		9 566 \$
8114	P.T.O. shaft	485 \$
PSIG-5472	Semi-industrial chute	963 \$
MLH-250-R	Chute rotation motor	591 \$
25TR04	Deflector cylinder	161 \$
TSB-4864	Hose support	60 \$
MLH-100	Motor for drum rotation	498 \$
P-720TRC-80 COMBO	Total:	12 324 \$

P-82126-HP		8 597 \$
8114	P.T.O. shaft	485 \$
PC3C-GR 1,5	Semi-industrial chute	1 354 \$
MLH-250-R	Chute rotation motor	591 \$
25TR04	Deflector cylinder	161 \$
TSB-4864	Hose support	60 \$
P-82126-HP COMBO	Total:	11 248 \$

P-82126TRC-HP		9 629 \$
8114	P.T.O. shaft	485 \$
PC3C-GR 1,5	Semi-industrial chute	1 354 \$
MLH-250-R	Chute rotation motor	591 \$
25TR04	Deflector cylinder	161 \$
TSB-4864	Hose support	60 \$
MLH-250-R	Motor for drum rotation	591 \$
P-82126TRC-HP COMBO	Total:	12 871 \$

GROUP II

P-800		8 812 \$
8114	P.T.O. shaft	485 \$
PSIG-7486	Semi-industrial chute	1 385 \$
MLH-250-R	Chute rotation motor	591 \$
25TR08	Deflector cylinder	164 \$
TSB-74104	Hose support	82 \$
P-800 COMBO	Total:	11 519 \$

P-800TRC		11 205 \$
8114	P.T.O. shaft	485 \$
PSIG-7486	Semi-industrial chute	1 385 \$
MLH-250-R	Chute rotation motor	591 \$
25TR08	Deflector cylinder	164 \$
TSB-74104	Hose support	82 \$
MLH-250-R	Motor for drum rotation	591 \$
P-800TRC COMBO	Total:	14 503 \$

P-860		9 240 \$
8202	P.T.O. shaft	541 \$
PSIG-7486	Semi-industrial chute	1 385 \$
MLH-250-R	Chute rotation motor	591 \$
25TR08	Deflector cylinder	164 \$
TSB-74104	Hose support	82 \$
P-860 COMBO	Total:	12 003 \$

P-860TRC		11 633 \$
8202	P.T.O. shaft	541 \$
PSIG-7486	Semi-industrial chute	1 385 \$
MLH-250-R	Chute rotation motor	591 \$
25TR08	Deflector cylinder	164 \$
TSB-74104	Hose support	82 \$
MLH-250-R	Motor for drum rotation	591 \$
P-860TRC COMBO	Total:	14 987 \$

P-862		12 100 \$
8202	P.T.O. shaft	541 \$
PSIG-7486	Semi-industrial chute	1 385 \$
MLH-250-R	Chute rotation motor	591 \$
25TR08	Deflector cylinder	164 \$
TSB-74104	Hose support	82 \$
P-862 COMBO	Total:	14 863 \$

P-862TRC		14 496 \$
8202	P.T.O. shaft	541 \$
PSIG-7486	Semi-industrial chute	1 385 \$
MLH-250-R	Chute rotation motor	591 \$
25TR08	Deflector cylinder	164 \$
TSB-74104	Hose support	82 \$
MLH-250-R	Motor for drum rotation	591 \$
P-862TRC COMBO	Total:	17 850 \$

P-860-92		9 543 \$
8202	P.T.O. shaft	541 \$
PSIG-7486	Semi-industrial chute	1 385 \$
MLH-250-R	Chute rotation motor	591 \$
25TR08	Deflector cylinder	164 \$
TSB-74104	Hose support	82 \$
P-860-92 COMBO	Total:	12 306 \$

P-860TRC-92		11 938 \$
8202	P.T.O. shaft	541 \$
PSIG-7486	Semi-industrial chute	1 385 \$
MLH-250-R	Chute rotation motor	591 \$
25TR08	Deflector cylinder	164 \$
TSB-74104	Hose support	82 \$
MLH-250-R	Motor for drum rotation	591 \$
P-860TRC-92 COMBO	Total:	15 292 \$

P-920		12 564 \$
9225	P.T.O. shaft	784 \$
PSIG-7486	Semi-industrial chute	1 385 \$
MLH-315-R	Chute rotation motor	604 \$
25TR08	Deflector cylinder	164 \$
TSB-74104	Hose support	82 \$
P-920 COMBO	Total:	15 583 \$

P-920TRC		14 958 \$
9225	P.T.O. shaft	784 \$
PSIG-7486	Semi-industrial chute	1 385 \$
MLH-315-R	Chute rotation motor	604 \$
25TR08	Deflector cylinder	164 \$
TSB-74104	Hose support	82 \$
MLH-315-R	Motor for drum rotation	604 \$
P-920TRC COMBO	Total:	18 581 \$

P-920-98		12 960 \$
9225	P.T.O. shaft	784 \$
PSIG-7486	Semi-industrial chute	1 385 \$
MLH-315-R	Chute rotation motor	604 \$
25TR08	Deflector cylinder	164 \$
TSB-74104	Hose support	82 \$
P-920-98 COMBO	Total:	15 979 \$

P-920TRC-98		15 355 \$
9225	P.T.O. shaft	784 \$
PSIG-7486	Semi-industrial chute	1 385 \$
MLH-315-R	Chute rotation motor	604 \$
25TR08	Deflector cylinder	164 \$
TSB-74104	Hose support	82 \$
MLH-315-R	Motor for drum rotation	604 \$
P-920TRC-98 COMBO	Total:	18 978 \$

P-922		15 601 \$
9225	P.T.O. shaft	784 \$
PSIG-7486	Semi-industrial chute	1 385 \$
MLH-315-R	Chute rotation motor	604 \$
25TR08	Deflector cylinder	164 \$
TSB-74104	Hose support	82 \$
P-922 COMBO	Total:	18 620 \$

P-922TRC		17 950 \$
9225	P.T.O. shaft	784 \$
PSIG-7486	Semi-industrial chute	1 385 \$
MLH-315-R	Chute rotation motor	604 \$
25TR08	Deflector cylinder	164 \$
TSB-74104	Hose support	82 \$
MLH-315-R	Motor for drum rotation	604 \$
P-922TRC COMBO	Total:	21 573 \$

P-922-98		16 061 \$
9225	P.T.O. shaft	784 \$
PSIG-7486	Semi-industrial chute	1 385 \$
MLH-315-R	Chute rotation motor	604 \$
25TR08	Deflector cylinder	164 \$
TSB-74104	Hose support	82 \$
P-922-98 COMBO	Total:	19 080 \$

P-922TRC 98		18 409 \$
9225	P.T.O. shaft	784 \$
PSIG-7486	Semi-industrial chute	1 385 \$
MLH-315-R	Chute rotation motor	604 \$
25TR08	Deflector cylinder	164 \$
TSB-74104	Hose support	82 \$
MLH-315-R	Motor for drum rotation	604 \$
P-922TRC-98 COMBO	Total:	22 032 \$

P-98134		13 680 \$
9225	P.T.O. shaft	784 \$
PSIG-7486	Semi-industrial chute	1 385 \$
MLH-315-R	Chute rotation motor	604 \$
25TR08	Deflector cylinder	164 \$
TSB-74104	Hose support	82 \$
P-98134 COMBO	Total:	16 699 \$

P-98134TRC		16 854 \$
9225	P.T.O. shaft	784 \$
PSIG-7486	Semi-industrial chute	1 385 \$
MLH-315-R	Chute rotation motor	604 \$
25TR08	Deflector cylinder	164 \$
TSB-74104	Hose support	82 \$
MLH-315-R	Motor for drum rotation	604 \$
P-98134TRC COMBO	Total:	20 477 \$

T-74104	Telescopic rod	price	96 \$
25TR08	Deflector cylinder	Credit	164 \$
TSB-74104	Hose support	Credit	82 \$
Credit for chute T-74104		Total:	(150) \$

GROUP III

P-980		15 115 \$
9225	P.T.O. shaft	784 \$
PSIG-92104	Semi-industrial chute	2 006 \$
MLH-315-R	Chute rotation motor	604 \$
25TR08	Deflector cylinder	164 \$
TSB-74104	Hose support	82 \$
P-980 COMBO	Total:	18 755 \$

P-980TRC		17 494 \$
9225	P.T.O. shaft	784 \$
PSIG-92104	Semi-industrial chute	2 006 \$
MLH-315-R	Chute rotation motor	604 \$
25TR08	Deflector cylinder	164 \$
TSB-74104	Hose support	82 \$
MLH-315-R	Motor for drum rotation	604 \$
P-980TRC COMBO	Total:	21 738 \$

P-1020		15 489 \$
9225	P.T.O. shaft	784 \$
PSIG-92104	Semi-industrial chute	2 006 \$
MLH-315-R	Chute rotation motor	604 \$
25TR08	Deflector cylinder	164 \$
TSB-74104	Hose support	82 \$
P-1020 COMBO	Total:	19 129 \$

P-1020TRC		17 866 \$	
9225	P.T.O. shaft	784 \$	
PSIG-92104	Semi-industrial chute	2 006 \$	
MLH-315-R	Chute rotation motor	604 \$	
25TR08	Deflector cylinder	164 \$	
TSB-74104	Hose support	82 \$	
MLH-315-R	Motor for drum rotation	604 \$	
P-1020TRC COMBO		Total:	22 110 \$

P-1040		15 650 \$	
9225	P.T.O. shaft	784 \$	
PSIG-92104	Semi-industrial chute	2 006 \$	
MLH-315-R	Chute rotation motor	604 \$	
25TR08	Deflector cylinder	164 \$	
TSB-74104	Hose support	82 \$	
P-1040 COMBO		Total:	19 290 \$

P-1040TRC		18 030 \$	
9225	P.T.O. shaft	784 \$	
PSIG-92104	Semi-industrial chute	2 006 \$	
MLH-315-R	Chute rotation motor	604 \$	
25TR08	Deflector cylinder	164 \$	
TSB-74104	Hose support	82 \$	
MLH-315-R	Motor for drum rotation	604 \$	
P-1040TRC COMBO		Total:	22 274 \$

P-1080		16 009 \$	
9225	P.T.O. shaft	784 \$	
PSIG-92104	Semi-industrial chute	2 006 \$	
MLH-315-R	Chute rotation motor	604 \$	
25TR08	Deflector cylinder	164 \$	
TSB-74104	Hose support	82 \$	
P-1080 COMBO		Total:	19 649 \$

P-1080TRC		18 388 \$	
9225	P.T.O. shaft	784 \$	
PSIG-92104	Semi-industrial chute	2 006 \$	
MLH-315-R	Chute rotation motor	604 \$	
25TR08	Deflector cylinder	164 \$	
TSB-74104x	Hose support	82 \$	
MLH-315-R	Motor for drum rotation	604 \$	
P-1080TRC COMBO		Total:	22 632 \$

PXPL			
PXPL-80		14 952 \$	
8114	P.T.O. shaft	485 \$	
PSIG-5472	Semi-industrial chute	963 \$	
MLH-250-R	Chute rotation motor	591 \$	
25TR04	Deflector cylinder	161 \$	
TSB-4864	Hose support	60 \$	
PXPL-80 COMBO		Total:	17 212 \$

PXPL-86		19 930 \$	
8202	P.T.O. shaft	541 \$	
PSIG-7486	Semi-industrial chute	1 385 \$	
MLH-250-R	Chute rotation motor	591 \$	
25TR08	Deflector cylinder	164 \$	
TSB-74104	Hose support	82 \$	
PXPL-86 COMBO		Total:	22 693 \$

PXPL-86-92		20 028 \$	
8202	P.T.O. shaft	541 \$	
PSIG-7486	Semi-industrial chute	1 385 \$	
MLH-250-R	Chute rotation motor	591 \$	
25TR08	Deflector cylinder	164 \$	
TSB-74104	Hose support	82 \$	
PXPL-86-92 COMBO		Total:	22 791 \$

PXPL-92		22 878 \$	
9225	P.T.O. shaft	784 \$	
PSIG-7486	Semi-industrial chute	1 385 \$	
MLH-315-R	Chute rotation motor	604 \$	
25TR08	Deflector cylinder	164 \$	
TSB-74104	Hose support	82 \$	
PXPL-92 COMBO		Total:	25 897 \$

PXPL-92-98		23 103 \$	
9225	P.T.O. shaft	784 \$	
PSIG-7486	Semi-industrial chute	1 385 \$	
MLH-315-R	Chute rotation motor	604 \$	
25TR08	Deflector cylinder	164 \$	
TSB-74104	Hose support	82 \$	
PXPL-92-98 COMBO		Total:	26 122 \$

CYCLONES

C7224		9 180,00 \$	
6248	P.T.O. shaft	422,00 \$	
PSIG-5472-C	Semi-industrial chute	963,00 \$	
MLH-250-R	Chute rotation motor	591,00 \$	
25TR04	Deflector cylinder	161,00 \$	
TSB-4864	Hose support	60 \$	
C7224 COMBO		Total:	11 377 \$

C8026		10 907 \$	
8114	P.T.O. shaft	485 \$	
PSIG-5472-C	Semi-industrial chute	963 \$	
MLH-250-R	Chute rotation motor	591 \$	
25TR04	Deflector cylinder	161 \$	
TSB-4864	Hose support	60 \$	
C8026 COMBO		Total:	13 167 \$

C9228		12 662 \$	
8202	P.T.O. shaft	541 \$	
PSIG-7486-C	Semi-industrial chute	1 385 \$	
MLH-315-R	Chute rotation motor	604 \$	
25TR08	Deflector cylinder	164 \$	
TSB-74104	Hose support	82 \$	
C9228 COMBO		Total:	15 438 \$

INVERTED P-INV

P-INV-74		9 586 \$	
8114	P.T.O. shaft	485 \$	
PSIG-INV-GR1	Semi-industrial chute IV Gr I	963 \$	
MLH-125	Chute rotation motor	526 \$	
25TR04	Deflector cylinder	161 \$	
TSB-4864	Hose support	60 \$	
P-INV-74 COMBO		Total:	11 781 \$

P-INV-80		9 751 \$	
8114	P.T.O. shaft	485 \$	
PSIG-INV-GR1	Semi-industrial chute IV Gr I	963 \$	
MLH-125	Chute rotation motor	526 \$	
25TR04	Deflector cylinder	161 \$	
TSB-4864	Hose support	60 \$	
P-INV-80 COMBO		Total:	11 946 \$

P-INV-92		12 686 \$	
8202	P.T.O. shaft	541 \$	
PSIG-INV-GR2	Semi-industrial chute IV Gr II	1 385 \$	
MLH-315-R	Chute rotation motor	604 \$	
25TR08	Deflector cylinder	164 \$	
TSB-74104	Hose support	82 \$	
P-INV-92 COMBO		Total:	15 462 \$

P-INV-92-102		13 286 \$
8202	P.T.O. shaft	541 \$
PSIG-INV-GR2	Semi-industrial chute IV Gr II	1 385 \$
MLH-315-R	Chute rotation motor	604 \$
25TR08	Deflector cylinder	164 \$
TSB-74104	Hose support	82 \$
P-INV-92-102 COMBO	Total:	16 062 \$

OPEN FLIGHT AUGER GV

P-82126-GV		11 187 \$
8114	P.T.O. shaft	485 \$
PC3C-GR1,5	Semi-industrial chute	1 354 \$
MLH-250-R	Chute rotation motor	591 \$
25TR04	Deflector cylinder	161 \$
TSB-4864	Hose support	60 \$
P-82126-GV COMBO	Total:	13 838 \$

P-82126TRC-GV		11 988 \$
8114	P.T.O. shaft	485 \$
PC3C-GR1,5	Semi-industrial chute	1 354 \$
MLH-250-R	Chute rotation motor	591 \$
25TR04	Deflector cylinder	161 \$
TSB-4864	Hose support	60 \$
MLH-250-R	Motor for drum rotation	591 \$
P-82126TRC-GV COMBO	Total:	15 230 \$

P-92130-GV		14 894 \$
9225	P.T.O. shaft	784 \$
PSIG-7486	Semi-industrial chute	1 385 \$
MLH-315-R	Chute rotation motor	604 \$
25TR08	Deflector cylinder	164 \$
TSB-74104	Hose support	82 \$
P-92130-GV COMBO	Total:	17 913 \$

P-92130TRC-GV		17 226 \$
9225	P.T.O. shaft	784 \$
PSIG-7486	Semi-industrial chute	1 385 \$
MLH-315-R	Chute rotation motor	604 \$
25TR08	Deflector cylinder	164 \$
TSB-74104	Hose support	82 \$
MLH-315-R	Motor for drum rotation	604 \$
P-92130TRC-GV COMBO	Total:	20 849 \$

P-98134-GV		16 040 \$
9225	P.T.O. shaft	784 \$
PSIG-7486	Semi-industrial chute	1 385 \$
MLH-315-R	Chute rotation motor	604 \$
25TR08	Deflector cylinder	164 \$
TSB-74104	Hose support	82 \$
P-98134-GV COMBO	Total:	19 059 \$

P-98134TRC-GV		18 465 \$
9225	P.T.O. shaft	784 \$
PSIG-7486	Semi-industrial chute	1 385 \$
MLH-315-R	Chute rotation motor	604 \$
25TR08	Deflector cylinder	164 \$
TSB-74104	Hose support	82 \$
MLH-315-R	Motor for drum rotation	604 \$
P-98134TRC-GV COMBO	Total:	22 088 \$

OPEN FLIGHT AUGER PGS GR I

PGS-740		16 248 \$
8202	P.T.O. shaft	541 \$
PSIR-5472	Semi-industrial chute	1 047 \$
MLH-250-R	Chute rotation motor	591 \$
25TR04	Deflector cylinder	161 \$
TSB-4864	Hose support	60 \$
PGS-740 COMBO	Total:	18 648 \$

PGS-800		16 451 \$
8202	P.T.O. shaft	541 \$
PSIR-5472	Semi-industrial chute	1 047 \$
MLH-250-R	Chute rotation motor	591 \$
25TR04	Deflector cylinder	161 \$
TSB-4864	Hose support	60 \$
PGS-800 COMBO	Total:	18 851 \$

OPEN FLIGHT AUGER PGS GR III

PGS-1020TRC		28 373 \$
9475	P.T.O. shaft	1 297 \$
PSIG-92104	Semi-industrial chute	2 006 \$
MLH-315-R	Chute rotation motor	604 \$
MLH-315-R	Motor for drum rotation	604 \$
25TR08	Deflector cylinder	164 \$
TSB-74104	Hose support	82 \$
PGS-1020TRC	Total:	33 130 \$

PGS-1080TRC		28 943 \$
9475	P.T.O. shaft	1 297 \$
PSIG-92104	Semi-industrial chute	2 006 \$
MLH-315-R	Chute rotation motor	604 \$
MLH-315-R	Motor for drum rotation	604 \$
25TR08	Deflector cylinder	164 \$
TSB-74104	Hose support	82 \$
PGS-1080TRC	Total:	33 700 \$

INDUSTRIAL SNOWBLOWERS- OPEN FLIGHT AUGER

PGV-1021TRC		42 153 \$
9599	P.T.O. shaft	1 675 \$
PR2G-250-2	Speed reducer and inverter	5 492 \$
MLH-315-R	Chute rotation motor	604 \$
MLH-315-R	Motor for drum rotation	604 \$
CLN-982	Basic lateral blades	412 \$
PGV-1021TRC COMBO	Total:	50 940 \$

PGV-120137TRC		59 246 \$
9599	P.T.O. shaft	1 675 \$
PR2G-250-3	Réducteur inverseur	5 540 \$
MLH-315-R	Chute rotation motor	604 \$
MLH-315-R	Motor for drum rotation	604 \$
CLN-982	Basic lateral blades	412 \$
PGV-120137TRC COMBO	Total:	68 081 \$

PGV-1022TRC		60 873 \$
9599	P.T.O. shaft	1 675 \$
PR2G-250-3	Réducteur inverseur	5 540 \$
MLH-315-R	Chute rotation motor	604 \$
MLH-315-R	Motor for drum rotation	604 \$
CLN-1022PGV	Basic lateral blades	487 \$
PGV-1022TRC COMBO	Total:	69 783 \$

PGV-1202TRC		63 959 \$
9599	P.T.O. shaft	1 675 \$
PR2G-250-3	Réducteur inverseur	5 540 \$
MLH-315-R	Chute rotation motor	604 \$
MLH-315-R	Motor for drum rotation	604 \$
CLN-1022PGV	Basic lateral blades	487 \$
PGV-1202TRC COMBO	Total:	<u>72 869 \$</u>

INDUSTRIAL SNOWBLOWERS- FULL FLIGHT AUGER

P-982TRC		39 998 \$
9599	P.T.O. shaft	1 675 \$
MLH-315-R	Chute rotation motor	604 \$
MLH-315-R	Motor for drum rotation	604 \$
CLN-982	Basic lateral blades	412 \$
P-982TRC COMBO	Total:	<u>43 293 \$</u>

P-1022TRC		56 338 \$
9599	P.T.O. shaft	1 675 \$
MLH-315-R	Chute rotation motor	604 \$
MLH-315-R	Motor for drum rotation	604 \$
CLN-1022	Basic lateral blades	487 \$
P-1022TRC COMBO	Total:	<u>59 708 \$</u>

SIDEWALK SNOWBLOWER - OPEN FLIGHT AUGER

P-542		15 009 \$
8114	P.T.O. shaft	485 \$
PSIG-5472	Semi-industrial chute	963 \$
MLH-250-R	Chute rotation motor	591 \$
25TR04	Deflector cylinder	161 \$
TSB-4864	Hose support	60 \$
P-542 COMBO	Total:	<u>17 269 \$</u>

P-54126-GV		10 811 \$
8114	P.T.O. shaft	485 \$
PC3C-GR 1,5	Semi-industrial chute	1 354 \$
MLH-250-R	Chute rotation motor	591 \$
25TR04	Deflector cylinder	161 \$
TSB-4864	Hose support	60 \$
P-54126-GV COMBO	Total:	<u>13 462 \$</u>

T-4864	Telescopic rod	price	96 \$
25TR04	Deflector cylinder	Credit	161 \$
TSB-4864	Hose support	Credit	60 \$
Credit for telescopic rod T-4864	Total:		<u>(125) \$</u>

SIDEWALK SNOWBLOWER - FULL FLIGHT AUGER

P-254		16 297 \$
8202	P.T.O. shaft	541 \$
PSIG-7486	Semi-industrial chute	1 385 \$
MLH-250-R	Chute rotation motor	591 \$
25TR08	Deflector cylinder	164 \$
TSB-74104	Hose support	82 \$
P-254 COMBO	Total:	<u>19 060 \$</u>

T-74104	Telescopic rod	price	96 \$
25TR08	Deflector cylinder	Credit	164 \$
TSB-74104	Hose support	Credit	82 \$
Credit for telescopic rod T-74104	Total:		<u>(150) \$</u>

SPEED REDUCER / INVERTER

110-81411	Inverter with SAE 80W90 oil	price	2 271 \$
PR-7502-1-KM	Mounting kit	Crédit	274 \$
Inverter PR-7502-1	Total:		<u>2 545 \$</u>

110-78081	Reducer Inverter with SAE 80W90 oil	price	2 307 \$
PR-7502-2-KM	Mounting kit	Crédit	238 \$
Reducer inverter PR-7502-2	Total:		<u>2 545 \$</u>

110-66651	Red. Inv. with MOBIL SHC GEAR 220	price	3 772 \$
PRH-25M-2-KM	Mounting kit	Crédit	301 \$
Reducer / Reducer inverter PRH-25M-2	Total:		<u>4 073 \$</u>

110-66651	Red. Inv. with MOBIL SHC GEAR 220	price	4 010 \$
PRH-25M-2,5-KV	Mounting kit	Crédit	404 \$
Reducer / Reducer inverter PRH-25M-2.5	Total:		<u>4 414 \$</u>

110-62121	Reducer & MOBIL SHC GEAR 220 oil	price	3 604 \$
PRH-30M-2-KM	Mounting kit	Crédit	297 \$
Reducer PRH-30M-2	Total:		<u>3 901 \$</u>

110-62121	Reducer & MOBIL SHC GEAR 220 oil	price	3 604 \$
PRH-30M-2.5-KV	Mounting kit	Crédit	380 \$
Reducer PRH-30M-2.5	Total:		<u>3 984 \$</u>

110-68721	Reducer & MOBIL SHC GEAR 220 oil	price	5 522 \$
PR3G200-2-KM	Mounting kit	Crédit	323 \$
Reducer PR3G200-2	Total:		<u>5 845 \$</u>

110-81401	Reducer & MOBIL SHC GEAR 220 oil	price	6 868 \$
PR3G250-2.5-KV	Mounting kit	Crédit	313 \$
Reducer PR3G250-2.5	Total:		<u>7 181 \$</u>

Reliability

Collegiality

Creating shared value



Consistency

Responsibility

Pride

Accountability



PRICE LIST 2023-2024

EFFECTIVE
2023-03-01

Our Agricultural Products / Dump Trailers Price List and our Snowblower Price List are now merged together.

Published once a year, our new Pronovost Price List is effective March 1st to February 28 of the following year and includes all our products.

Les Machineries Pronovost inc.
Let's Go Forward !

260, Haut du Lac Sud (route 159)
Saint-Tite, Quebec, Canada GOX 3H0
Tel.: 418 365-7551
Fax : 418 365-7954
www.pronovost.qc.ca
info@pronovost.qc.ca

Snowblowers on the back.

2023_LP12

AGRICULTURAL PRODUCTS

HAY EQUIPMENT
BALE HANDLERS, MACERATOR

DUMP TRAILERS
OFF-ROAD SERVICE





Visit our website
www.pronovost.qc.ca



LesMachineriesPronovost



machineriespronovost



Pronovostinc

Copyright© Les Machineries Pronovost Inc., 2023

All rights reserved.
Printed in Canada.

**INDEX**

Item	Page
Agland Macerator.....	4
Off-Road Dump Trailers.....	5
Auto-load Round Bale Handlers	10
Multimixer	12
Auto-load Bale Handlers Specifications.....	13
Off-Road Dump Trailers Specifications	14

F.O.B. St-Tite, Quebec, Canada.



MACERATOR

Agland authorized
dealers only



MAXIMIZE YOUR FEED VALUE !

- ✓ Gently nicks and cracks the stems.
- ✓ Heavy duty.
- ✓ Doesn't require tools for in field adjustments.
- ✓ The height of the collector is easily adjustable from the tractor.
- ✓ The unique pneumatic system works like a shock absorber and keeps the rolls tight together.
- ✓ Air pressure can easily and quickly be adjusted with a simple turn of the knob for maximum performance in various field conditions.

INTENSIVE FORAGE CONDITIONING PROMOTES :

- ✓ Faster dry down time.
- ✓ Better feed value.
- ✓ More palatability.
- ✓ Improved color and texture.

Visit our website to see the results from studies
about the Macerator and a video.

MODEL	DESCRIPTION		SUGGESTED RETAIL
6620-540	<ul style="list-style-type: none"> • Macerator for 540 RPM PTO. • Tires 11 L - 15 SL. • Suggested tractor size : 80 to 125 HP (60 to 93 kW). • Operating speed up to 10 MPH (16 km/hr). • Pickup 66" (165 cm) width. • Swath cuts up to 14' (426 cm). • Windrow 66" (165 cm) width. 	4400 lbs (1996 kg)	50,592. \$
6620-1000	<ul style="list-style-type: none"> • Macerator for 1000 RPM PTO. • Same as above. 	4500 lbs (2041 kg)	50,592. \$
OPTION			
801324	<p>WINDROWER</p> <p>Required with the "Power Merger". Returns product in a smooth evenly distributed windrow. The operator sets the windrow width.</p>	174 lbs (79 kg)	1,445. \$
807718	<p>SWATH SPREADER</p> <p>For extra aeration provides a thinner and a wider swath. Raking may be necessary to put the material back into a swath form.</p>	109 lbs (50 kg)	714. \$
808573	<p>MOLDBOARD MERGER</p> <p>Moves and turns the windrow up to 6' to one side, depending on the setting.</p>	139 lbs (63 kg)	2,816. \$
801682	<p>TEDDER (requires "attachment kit for Tedder #807883"). Allows the spreading of the crop as wide as possible (13' to 24').</p>	900 lbs (409 kg) with tedder attachment	3,555. \$
807883	Attachment kit for Tedder. Attachment hardware and hydraulic system without the "Tedder".		4,748. \$

Prices and specifications subject to change without notice. ALL TAXES EXTRA WHEN APPLICABLE.

WARRANTY: One (1) year on manufacturing defects - void if the product has been altered.



OFF-ROAD DUMP TRAILERS



RECOGNIZED MECHANIC, SUPERIOR DESIGN

- ✓ Quality engineered.
- ✓ Sturdy frame and reinforced floor.
- ✓ Removable profiled panels.
- ✓ Automatic opening of rear panel (except on P-503).
- ✓ Jack.
- ✓ Swivel hitch.
- ✓ Precision engineering and impeccable finish.
- ✓ Wide range of models.
- ✓ Dependable and built to last.

1.5 TONS (3000 LBS) - REAR DUMPING



P-503

2.5 TONS (5000 LBS) - REAR DUMPING



P-505

MODEL	DESCRIPTION	SUGGESTED RETAIL
P-503	<ul style="list-style-type: none"> • 1.5 tons (3000 lbs). • Rear dumping. • Trailer 4' 2 1/2" x 5' 10". • Interior dimensions 50 1/2" x 70". • Tandem axle. 4 tires 18 x 8.5 x 8. • 12" removable panels. • Tailgate opens from top or bottom. 	5,072. \$
P-505	<ul style="list-style-type: none"> • 2.5 tons (5000 lbs). • Rear dumping. • Trailer 5' x 7' 10". • Interior dimensions 60" x 94". • Tandem axle. • 4 tires Turf-Trac 4 plys 23" x 10.5" x 12" (tires for turf application). • 14" removable panels. 	9,076. \$
OPTION		
PHM3003	Manual hydraulic pump for P-503, high volume. Quick lift.	1,034. \$
P-503-PHEP	For P-503, electric hydraulic pump (12V). Battery and battery holder not included (pump shown on page 9).	1,794. \$
P-505-PHEP	For P-505, electric hydraulic pump (12V). Battery and battery holder not included (pump shown on page 9).	2,033. \$
P-500-SB	Battery holder (battery not included).	110. \$
P-505M	For P-505, 4 tires Multi Trac 6 plys 23" x 10.5" x 12" in lieu of Turf-Trac tires ¹ (tires shown on next page). ➔	Surcharge 423. \$

Note : Cylinders and hoses included, quick couplings included.

¹ Surcharge for option in replacement of the regular component.



OFF-ROAD DUMP TRAILERS



4 TONS (8000 LBS) - 3 SIDES DUMPING



P-508/3S

4 TONS (8000 LBS) - REAR DUMPING



P-509-60

MODEL	DESCRIPTION	SUGGESTED RETAIL
P-508/3S	<ul style="list-style-type: none"> • 4 tons (8000 lbs). (See note 1 page 14). • Dumps on 3 sides. • Trailer 5' 2" x 8' 3". • Interior dimensions 62" x 99" x 3/16". • Single axle. • 2 tires 11L15. • 14" removable panels. 	10,222. \$
P-509-60	<ul style="list-style-type: none"> • 4 tons (8000 lbs). (See note 1 page 14). • Rear dumping only. • Trailer 5' 11" x 8' 9". • Interior dimensions 71" x 105" x 3/16". • Single axle. • 2 tires 11L15. • 19" high x 12G removable panels. 	9,650. \$
OPTION		
XT2-11L15FI	Charge for 11L15FI (D) tires instead of 11L15 tires ¹ . FI tire is made for agricultural and road use*. Increase recommended maximum speed from 25 MPH to 60 MPH.	Surcharge 335. \$
P-510-PHEP	For P-508/3S, electric hydraulic pump (12V). Battery and battery holder not included (pump shown on page 9).	2,033. \$
P-511-PHEP	For P-509-60, electric hydraulic pump (12V). Battery and battery holder not included (pump shown on page 9).	2,033. \$
P-500-SB	Battery holder (battery not included).	110. \$
P-510G-E	Rear panel with central unloading hatch for P-508/3S ¹ (shown on page 9).	Surcharge 337. \$
P-511G-E	Rear panel with central unloading hatch for P-509-60 ¹ (shown on page 9).	Surcharge 337. \$

Note : Cylinders and hoses included, quick couplings included.

* According to the manufacturer's loading specifications.

← TIRE PICTURES FOR MODEL P-505

Standard tires
Turf-Trac



Optional tires
Multi Trac



¹ Surcharge for option in replacement of the regular component.



5 TONS (10 000 LBS) - 3 SIDED DUMPING



P-510/3S

5 TONS (10 000 LBS) - REAR DUMPING



P-511-60

MODEL	DESCRIPTION	SUGGESTED RETAIL
P-510/3S	<ul style="list-style-type: none"> • 5 tons (10 000 lbs). • Dumps on 3 sides. • Trailer 5' 2" x 8' 3". • Interior dimensions 62" x 99" x 3/16". • Tandem axle. • 4 tires 11L15. • 14" removable panels. 	11,971. \$
P-511-60	<ul style="list-style-type: none"> • 5 tons (10 000 lbs). • Rear dumping. • Trailer 5' 11" x 8' 9". • Interior dimensions 71" x 105" x 3/16". • Tandem axle. • 4 tires 11L15. • 19" high x 12G removable panels. 	10,666. \$
OPTION		
XT2-11L15FI	Charge for 11L15FI (D) tires instead of 11L15 tires ¹ . FI tire is made for agricultural and road use*. Increase recommended maximum speed from 25 MPH to 60 MPH.	Surcharge 335. \$
P-510-PHEP	For P-510/3S, electric hydraulic pump (12V). Battery and battery holder not included (pump shown on page 9).	2,033. \$
P-511-PHEP	For P-511-60, electric hydraulic pump (12V). Battery and battery holder not included (pump shown on page 9).	2,033. \$
P-500-SB	Battery holder (battery not included).	110. \$
P-510G-E	Rear panel with central unloading hatch for P-510/3S ¹ (shown on page 9).	Surcharge 337. \$
P-511G-E	Rear panel with central unloading hatch for P-511-60 ¹ (shown on page 9).	Surcharge 337. \$

Note : Cylinders and hoses included, quick couplings included.

¹ Surcharge for option in replacement of the regular component.



OFF-ROAD DUMP TRAILERS



8 TONS (16 000 LBS) - REAR DUMPING



P-516

8 TONS (16 000 LBS) - 3 SIDED DUMPING



P-516/3S

MODEL	DESCRIPTION	SUGGESTED RETAIL
P-516	<ul style="list-style-type: none"> • 8 tons (16 000 lbs). (See note 1 page 14). • Rear dumping only. • Trailer 4' 7" x 9' 9 1/2". • Interior dimensions 55" x 117 1/2" x 3/16". • Tandem axle. • 4 tires 11L15. • 16" removable panels. 	11,816. \$
P-516/3S	<ul style="list-style-type: none"> • 8 tons (16 000 lbs). (See note 1 page 14). • Dumps on 3 sides. • Trailer 7' 6" x 10'. • Interior dimensions 90" x 120" x 3/16". • Tandem axle. • 4 tires 11L15. • 16" removable panels. 	15,921. \$
OPTION		
XT4-11L15FI	Charge for 11L15FI (D) tires instead of 11L15 tires ¹ . FI tire is made for agricultural and road use*. Increase recommended maximum speed from 25 MPH to 60 MPH.	Surcharge 663. \$
XT4-12.5L15	Charge for 12.5L15 tires instead of 11L15 tires ¹ . Increase recommended maximum speed from 25 MPH to 60 MPH.	Surcharge 459. \$
P-516-PHEP	For P-516, electric hydraulic pump (12V). Battery and battery holder not included (pump shown on page 9).	2,033. \$
P-5163S-PHEP	For P-516/3S, electric hydraulic pump (12V). Battery and battery holder not included (pump shown on page 9).	2,033. \$
P-500-SB	Battery holder (battery not included).	110. \$
P-516G-E	Rear panel with central unloading hatch for P-516 ¹ (shown on page 9).	Surcharge 337. \$
P-516/3SG-E	Rear panel with central unloading hatch for P-516/3S ¹ (shown on page 9).	Surcharge 337. \$

Note : Cylinders and hoses included, quick couplings included.

* According to the manufacturer's loading specifications.

¹ Surcharge for option in replacement of the regular component.



12 TONS (24 000 LBS) - REAR DUMPING



MODEL	DESCRIPTION	SUGGESTED RETAIL
P-524	<ul style="list-style-type: none"> • 12 tons (24 000 lbs). (See note 2 page 14) • Rear dumping. • Trailer 7' x 11' 6". • Interior dimensions 84" x 138" x 3/16". • Tandem axle. 4 tires 12.5L15. • 24" removable panels. • Central unloading hatch (shown below). 	23,320. \$
OPTION		
XT4-12.5L15FI	Charge for 12.5L15FI (F) tires instead of 12.5L15 tires ¹ . FI tire is made for agricultural and road use*. Increase recommended maximum speed from 25 MPH to 60 MPH.	Surcharge 725. \$

Note : Cylinders and hoses included, quick couplings included.

* According to the manufacturer's loading specifications.

OPTIONS PICTURES

HYDRAULIC PUMP



MANUAL

PHM3003



12 VOLTS

P-503-PHEP



12 VOLTS

P-505-PHEP
P-510-PHEP
P-511-PHEP
P-516-PHEP
P-5163S-PHEP

CENTRAL UNLOADING HATCH



Standard on P-524.

Optionnal on
P-508/3S, P-509-60,
P-510/3S, P-511-60,
P-516 and P-516/3S.

¹ Surcharge for option in replacement of the regular component.

Prices and specifications subject to change without notice. ALL TAXES EXTRA WHEN APPLICABLE.

WARRANTY: One (1) year on manufacturing defects - void if the product has been altered.



AUTO-LOAD ROUND BALE HANDLERS



THE STATE OF THE ART EQUIPMENT FOR ROUND BALE HANDLING

- ✓ Heavy duty construction and precise engineering.
- ✓ Patented loading arm for turning and quick loading of the bales without stopping.
- ✓ Choice of electric or manual controls.
- ✓ Can handle 4' and 5' diameter bales.
- ✓ Choice of 6 models to meet all requirements.
- ✓ Road lights included.

Entirely double acting hydraulic system optional on all models.

MODEL	DESCRIPTION	SUGGESTED RETAIL
10 BALE MODELS		
P-6810M	<ul style="list-style-type: none"> • Loads and transports 10 bales 4' lg or 8 bales 5' lg. • Unloads horizontally in two parallel rows. • Total capacity 12 tons GVWR (tires 16.5L16.1). • Manually activated from the tractor's controls. • 3 hydraulic double action outlets required. • Suggested tractor : 80 HP PTO or over. • Adjustable sides for 4' to 5' diameter bales. 	41,118. \$
P-6810	<ul style="list-style-type: none"> • Same as manual model but with electric control installed in the tractor cab, connected to three electro-hydraulic valves. • Automatic return of the bale ram. • Supplied by only one hydraulic double action outlet. 	47,526. \$
12 BALE MODELS		
P-6812M	<ul style="list-style-type: none"> • Loads and transports 12 bales 4' lg or 10 bales 5' lg. • Unloads horizontally in two parallel rows. • Total capacity 12 tons GVWR (tires 16.5L16.1). • Manually activated from the tractor's controls. • 3 hydraulic double action outlets required. • Suggested tractor : 100 HP PTO or over. • Adjustable sides for 4' to 5' diameter bales. 	45,493. \$
P-6812	<ul style="list-style-type: none"> • Same as manual model but with electric control installed in the tractor cab, connected to three electro-hydraulic valves. • Automatic return of the bale ram. • Supplied by only one hydraulic double action outlet. 	51,902. \$
16 BALE MODELS		
P-6816M	<ul style="list-style-type: none"> • Loads and transports 16 bales 4' lg or 12 bales 5' lg. • Unloads horizontally in two parallel rows. • Total capacity 16 tons GVWR (tires 21.5L16.1). • Manually activated from the tractor's controls. • 3 hydraulic double action outlets required. • Suggested tractor : 125 HP PTO or over. • Adjustable sides for 4' and 5' diameter bales. 	60,657. \$
P-6816	<ul style="list-style-type: none"> • Same as manual model but with electric control installed in the tractor cab, connected to three electro-hydraulic valves. • Automatic return of the bale ram. • Supplied by only one hydraulic double action outlet. 	67,530. \$



AUTO-LOAD ROUND BALE HANDLERS



OPTION	DESCRIPTION	SUGGESTED RETAIL
	THIRD ROW LOADER	
P-6891TRM ★ INCREASE YOUR LOADING CAPACITY !	For manual models, third row loader option, 4' or 5' diameter bales. Manually actuated from the tractor's controls. Supplied by a fourth hydraulic double action outlet (floating required). The bales must not exceed 1500 lbs. For safety purpose, the third bale must not be loaded at the last rear bales group. (For 12 bale and 16 bale models, optional tires are necessary in order to increase the load capacity to carry silage bales).	6,018. \$
P-6891TR ★	Same as above, but for automatic models, adapt to the electric control. Fourth electro-hydraulic valve included.	6,290. \$
	BALES 6' ADAPTOR	RETAIL
P-6890XL	Option to handle 6' diameter bales on the 10 bale and 12 bale models.	995. \$
P-6896XL	Same as above, for 16 bales models.	1,283. \$
	SUPPLEMENTARY OIL OUTLET	RETAIL
P-6892VE	For manual models, electric valve kit to add a supplementary oil outlet (the kit is installed on the auto-loader). It is also possible to sell the valve alone not installed at 615. \$	1,116. \$
	CONVERSION KIT	RETAIL
P-6890CF	Electrical conversion kit for tractors with closed hydraulic circuit. Note : if the tractor's hydraulics are load sensing, this option is not required.	802. \$
	OPTIONAL TIRES	SURCHARGE
XT4-21.5L16.1	For 12 bale models, optional tires 21.5L16.1 ¹ , 10 plys, in lieu of 16.5L16.1 tires (this option increases the flotation by 50% and increases the capacity to 16 tons).	Surcharge 1,488. \$
HIGH-FLOTATION XT4-400/55-22.5-BKT	GVWR 12 tons, 10 plys, in lieu of tires 16.5L16.1 For 10 and 12 bale models, tires 400/55-22.5 ¹	Surcharge 1,768. \$
HIGH-FLOTATION XT4-500/45-22.5-2BKT XT4-550/45-22.5-2BKT	GVWR 12 tons, 16 plys, in lieu of tires 16.5L16.1 For 12 bale models, tires 500/45-22.5 BKT ¹ For 12 bale models, OVERWIDTH, tires 550/45-22.5 BKT ¹	Surcharge 3,149. \$ 3,937. \$
HIGH-FLOTATION XT4-500/45-22.5-BKT XT4-550/45-22.5-BKT	GVWR 16 tons, 16 plys, in lieu of tires 21.5L16.1 For 16 bale models, tires 500/45-22.5 BKT ¹ For 16 bale models, OVERWIDTH, tires 550/45-22.5 BKT ¹	Surcharge 1,660. \$ 2,449. \$
	HYDRAULIC BRAKES	RETAIL
XXXX ★	For all models, optional hydraulic brake kit. Including : change of tandems, disc brakes, hydraulic lines and hoses for connection to the outlet "hydraulic trailer brakes" of the tractor.	On demand
	HYDRAULIC JACK	RETAIL
XXXX	Hydraulic jack option, in place of manual jack.	On demand

★ N.B.: This option is available only when ordered at the same time as the Auto-load Round Bale Handler, before the production.
N.B.: For option on a delivered machine, call our sales department to get a quote.

¹ Surcharge for option in replacement of the regular component.

Prices and specifications subject to change without notice. ALL TAXES EXTRA WHEN APPLICABLE.
WARRANTY: One (1) year on manufacturing defects - void if the product has been altered.



MULTIMIXER



- ✓ 6.2 cu.ft. capacity.
- ✓ Spiral vane to mix and to unload by reversing the rotation.
- ✓ Easy to clean.
- ✓ Mix remains homogenous even when pouring small quantities at a time.
- ✓ Can also be used as an all purpose mixer to mix concentrate, feed, minerals, seeds, treat corn, inoculate soya beans, etc.
- ✓ Weight : 365 lbs / 166 kg.

MODEL	DESCRIPTION	SUGGESTED RETAIL
P-110	<ul style="list-style-type: none"> • All purpose mixer complete with hydraulic motor. • Cushion valve complete with hoses. • Adjustable stand included. 	3,277. \$
OPTION		
P-113SSL	Quick attach for skid steer loader.	1,058. \$

¹ Surcharge for option in replacement of the regular component.

Prices and specifications subject to change without notice. ALL TAXES EXTRA WHEN APPLICABLE.

WARRANTY: One (1) year on manufacturing defects - void if the product has been altered.

AUTO-LOAD BALE HANDLERS SPECIFICATIONS

ROUND BALES

MODELS	P-6810M	P-6810	P-6812M	P-6812	P-6816M	P-6816
Functions control	By 3 outlets	By 3 outlets	By 3 outlets	By 3 outlets	By 3 outlets	By 3 outlets
Sides adjustable to bale diameter	4' à 5 1/2' std. (6' opt.)	4' à 5 1/2' std. (6' opt.)	4' à 5 1/2' std. (6' opt.)	4' à 5 1/2' std. (6' opt.)	4' à 5 1/2' std. (6' opt.)	4' à 5 1/2' std. (6' opt.)
Bale lengths	4' à 5 1/2' std.	4' à 5 1/2' std.	4' à 5 1/2' std.	4' à 5 1/2' std.	4' à 5 1/2' std.	4' à 5 1/2' std.
Number of wheel bolts	8	8	8	8	8	8
Overall length	27' 6"	27' 6"	31' 10"	31' 10"	39' 10"	39' 10"
Overall width (empty)	8' 6" à 10' 0"	8' 6" à 10' 0"	8' 6" à 10' 0"	8' 6" à 10' 0"	8' 6" à 10' 0"	8' 6" à 10' 0"
Platform height (standard tires)	44 5/8"	44 5/8"	45 1/2"	45 1/2"	47 1/4"	47 1/4"
Platform height (optional tires)	- - -	- - -	47 1/4"	47 1/4"	47 1/4"	47 1/4"
Dumping angle	35°	35°	35°	35°	35°	35°
Dumping cylinder	2 double action	2 double action	2 double action	2 double action	2 double action	2 double action
Thread width (center/center)	83 5/8"	83 5/8"	80"	80"	80"	80"
Hitch weight approx. (empty)	1 500 lbs (680 kg)	1 500 lbs (680 kg)	1 800 lbs (820 kg)	1 800 lbs (820 kg)	2 300 lbs (1 040 kg)	2 300 lbs (1 040 kg)
Hitch	Swivel hitch	Swivel hitch	Swivel hitch	Swivel hitch	Swivel hitch	Swivel hitch
Manual jack	Included	Included	Included	Included	Included	Included
Hydraulic jack	NA	NA	NA	NA	NA	NA
Oil flow required	57 to 68 liters / min. (15 to 18 gallons US / min.)	57 to 68 liters / min. (15 to 18 gallons US / min.)	57 to 68 liters / min. (15 to 18 gallons US / min.)	57 to 68 liters / min. (15 to 18 gallons US / min.)	57 to 68 liters / min. (15 to 18 gallons US / min.)	57 to 68 liters / min. (15 to 18 gallons US / min.)
Transhydraulic oil volume required at the initial filling (made by Pronovost)	85 liters (22,4 gallons US)	73 liters (19,2 gallons US)	106 liters (27,9 gallons US)	92 liters (24,4 gallons US)	156 liters (41,2 gallons US)	145 liters (38,3 gallons US)
Maximum oil reserve required in operation	20 liters (5,3 gallons US)	20 liters (5,3 gallons US)	24 liters (6,3 gallons US)	24 liters (6,3 gallons US)	40 liters (10,6 gallons US)	40 liters (10,6 gallons US)
Full load indicator	Mechanical rod	Mechanical rod	Mechanical rod	Mechanical rod	Mechanical rod	Mechanical rod
Automatic return of bale ram	NA	Std	NA	Std	NA	Std
Remote control	NA	Std	NA	Std	NA	Std
Counter weight holder ¹	Included	Included	Included	Included	Included	Included
Axle	Tandem	Tandem	Tandem	Tandem	Tandem	Tandem
Hum capacity	8 000 lbs (3 636 kg)	8 000 lbs (3 636 kg)	10 000 lbs (4 545 kg)	10 000 lbs (4 545 kg)	10 000 lbs (4 545 kg)	10 000 lbs (4 545 kg)
Spindles diameter	3"	3"	3 1/4"	3 1/4"	3 1/4"	3 1/4"
Road lights	Included	Included	Included	Included	Included	Included
Hydraulic brakes	Opt.	Opt.	Opt.	Opt.	Opt.	Opt.
Recommended horse power	80 HP PTO	80 HP PTO	100 HP PTO	100 HP PTO	125 HP PTO	125 HP PTO
Gross vehicle weight rating	24 000 lbs (10 886 kg)	24 000 lbs (10 886 kg)	24 000 lbs (10 886 kg)	24 000 lbs (10 886 kg)	32 000 lbs (14 515 kg)	32 000 lbs (14 515 kg)
Total weight empty (approx.)	6 350 lbs (2 880 kg)	6 350 lbs (2 880 kg)	7 300 lbs (3 311 kg)	7 300 lbs (3 311 kg)	8 400 lbs (3 810 kg)	8 400 lbs (3 810 kg)

¹ Counterweight not included

Design and specifications subject to change without notice.

OFF-ROAD DUMP TRAILERS SPECIFICATIONS

MODELS	P-503	P-505	P-508/3S	P-509-60	P-510/3S	P-511-60	P-516	P-516/3S	P-524
Gross vehicle weight rating	1.5 tons	2.5 tons	4 tons ¹	4 tons ¹	5 tons	5 tons	8 tons ¹	8 tons ¹	12 tons ²
Box (interior dimensions)	50 1/2" x 69 1/2"	60" x 94"	62" x 99"	71" x 105"	62" x 99"	71" x 105"	55 5/8" x 117 1/2"	90" x 120"	84" x 138"
Bed thickness	12G	3/16"	3/16"	3/16"	3/16"	3/16"	3/16"	3/16"	3/16"
Side panel	12" x 12G	14" x 12G	14" x 12G	14" x 12G	14" x 12G	14" x 12G	16" x 12G	16" x 12G	24" x 12G
Front / back panel	12 1/4" x 12G	19" x 12G	19" x 12G	19" x 12G	19" x 12G	19" x 12G	24" x 12G	24" x 12G	32" x 12G
Removable panel	4	4	4	4	4	4	4	4	4
Rear panel opening	From top or bottom	Automatic	Automatic	Automatic	Automatic	Automatic	Automatic	Automatic	Automatic
Platform height	22"	29 1/2"	35 1/2"	35 1/2"	35 1/2"	35 1/2"	32"	36 1/2"	39"
Overall length	106"	139"	143"	147"	143"	147"	166"	177"	200 1/2"
Overall width	54"	64"	68"	77"	68"	77"	86"	97"	91"
Overall height	36"	52 1/2"	60"	60"	60"	60"	62"	65"	72"
Free height / max. lift	10"	15"	20"	14"	20"	14"	15"	20"	20"
Total height / max. lift	72"	103"	117"	108"	117"	108"	122"	130"	154"
Tread width c / c	36 1/4"	53 1/4"	51"	60"	51"	60"	75 1/2"	75"	72 1/2"
Dumping angle (back)	47°	47°	47°	47°	47°	47°	47°	47°	47°
Dumping angle (2 sides)	.	.	47°	.	47°	.	.	47°	.
Rear panel with grain door	.	.	Option	Option	Option	Option	Option	Option	Included
Axle	Tandem	Tandem	Single	Single	Tandem	Tandem	Tandem	Tandem	Tandem
Suspension
Hubs	4 bolts	5 bolts	6 bolts	6 bolts	6 bolts	6 bolts	6 bolts	6 bolts	8 bolts
Hub capacity	1 000 lbs	2 500 lbs	5 000 lbs	5 000 lbs	4 000 lbs	4 000 lbs	5 000 lbs	5 000 lbs	5 500 lbs
Spindles	1 1/4"	2"	2 1/4"	2 1/4"	2"	2"	2 1/4"	2 1/4"	2 1/4"
Wheels	4	4	2	2	4	4	4	4	4
Wheels dimensions	8.5" x 8"	12" x 8.5"	15" x 8"	15" x 8"	15" x 8"	15" x 8"	15" x 8"	15" x 8"	15" x 10"
Tires (included)	18 x 8.5 x 8"	Turf-Trac 23 x 10.5 x 12"	11L15 (8 plys)	11L15 (8 plys)	11L15 (8 plys)	11L15 (8 plys)	11L15 (8 plys)	11L15 (8 plys)	12.5L15 (10 plys)
Tires (optional)	.	Multi trac 23 x 10.5 x 12"	11L15FI (D)	11L15FI (D)	.	.	11L15FI (D)	11L15FI (D)	12.5L15FI (F)
Tires (optional)	12.5L15 (10 plys)	12.5L15 (10 plys)	.
Hitch : Clevis / swivel	Included	Included	Included	Included	Included	Included	Included	Included	Included
Hitch : Ball coupler
Jack	Included	Included	Included	Included	Included	Included	Included	Included	Included
Oil volume required max. lift	0,2 L	0,4 L	5 L	0,4 L	5 L	0,4 L	1,1 L	5,2 L	11 L
Manual hydraulic pump	Option	-	-	-	-	-	-	-	-
12V hydraulic pump	Option	Option	Option	Option	Option	Option	Option	Option	Option
Cylinder(s)	1 double acting	1 double acting	1 single acting	1 double acting	1 single acting	1 double acting	2 double acting	1 single acting	1 single acting
Approximate total weight	640 lbs	1 560 lbs	1 840 lbs	1 725 lbs	2 100 lbs	2 060 lbs	2 245 lbs	3 040 lbs	4 195 lbs

¹ Capacity with 11L15FI (D) tires at a speed of 60 MPH (96 km/h). ² Capacity with 12.5L15FI (F) tires at a speed of 60 MPH (96 km/h).

Design and specifications subject to change without notice.