



UTILITY AUGERS



FOR USE ON THE FOLLOWING CARRIES

Mini Digger Derricks, Digger Derricks and Pressure Diggers



PENGO AUGER SOIL CHART



Pengo has developed the chart below to help you decide which auger will be best suited for your project. The above triangles and color guide will be included with all products where applicable.



1	dirt; peat, organic silts, very loose sand, very soft, swamp, marsh	soil abrasion: low
2	sand; loose, fine sand; loess and medium clay, flood plain soils, lake clay	soil abrasion: medium
3	silt; coarse sand to stiff clay, dense hydraulic fill, compacted fill, residual soils	soil abrasion: high
4	clay; stiff to very stiff clay, glacial till, hard-pan, marls	soil abrasion: low to medium
5	gravel; basalt, very hard silts and clay, weathered laminated rock	soil abrasion: high
6	fracturable rock; caliche, coarse gravel and cobbles; frozen soil	soil abrasion: high
7	non-fracturable rock; granite, basalt, massive limestone	soil abrasion: high

PENGO UTILITY AUGERS

Pengo will commonly refer to the "parts" of the auger to help determine which one is suitable to your needs. Please use this as a reference guide when determining the auger you would like quoted.

Carrier	Auger(s) Compatible
 Mini Digger Derrick	TriMax® Auger
 Digger Derrick	MD Utility, Step Rock, Rock Ripper, MD Quick Change System
 Pressure Digger	Pressure Digger Dirt and Pressure Digger Rock

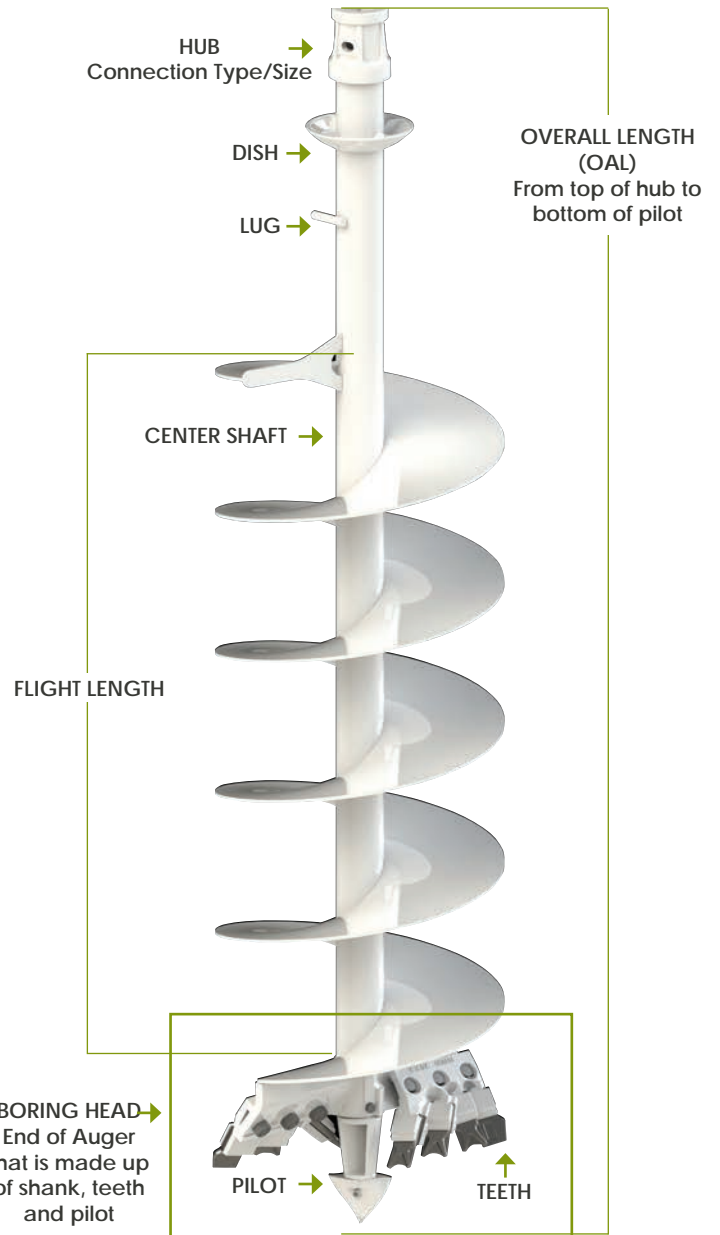

UTILITY AUGERS



88", 102" and 104" OAL

Recessed Socket connection provides added stability

FACT: In the Fall of 2015 the Pengo Utility auger received some improved features making this the "go-to" utility auger.



Patent Pending Flight Stabilizer Gusset

Seam Welds for Increased Life-Cycle

5/16" Flight Thickness

High Yield 4" OD x 3/8" Wall Center Shaft

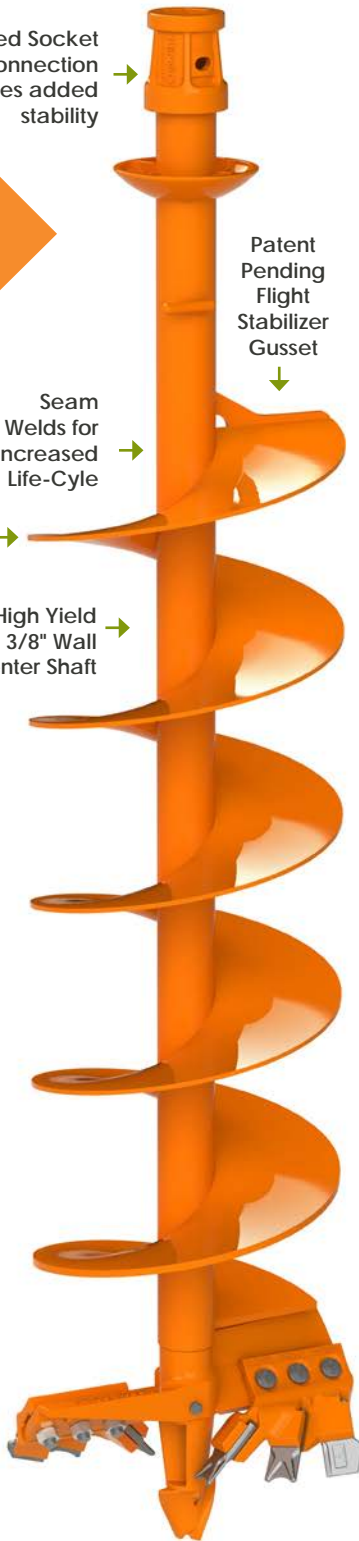

AVAILABLE OPTIONS:

1. **Standard Dirt (SHOWN)**
FH-205 Pilot, 1851 and 1652 Fas-N-Lok® Teeth
2. **Standard Dirt**
P-1650 Pilot, 1851 and 1652 Fas-N-Lok® Teeth
3. **Standard Dirt**
TF-600 Pilot, 1851 and 1652 Fas-N-Lok® Teeth
4. **Carbide**
FH-205C Pilot, 1658 and 1656 Fas-N-Lok® Teeth
5. **Carbide**
P-1656 Pilot, 1658 and 1656 Fas-N-Lok® Teeth
6. **Rock**
RCP-6.5 Pilot, SL-02 Conical Teeth

CONNECTIONS



AUGER DIAMETERS



CUT DIAMETER

Cut diameter is 1 1/2" larger than auger diameter.

DRILLING SOIL CONDITIONS:



Originally a Pengo patent, our MD auger line is the most widely used utility auger in the world. Recent enhancements include a recessed hub connection for added stability, seam welds for increased life cycle, high yield center shaft walls and a patent pending flight stabilizer gusset. Offered in a wide variety of flight lengths and head options, Pengo can provide a customized auger specifically for your drilling applications.

UTILITY AUGERS

UTILITY AUGERS

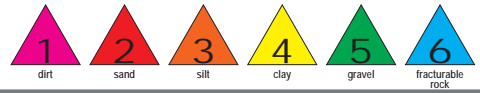

DIRT AUGERS | 104" Overall Length, 60" Flight



Item Description

ITEM	DIA	NO. 1851
8-MD-10460	8"	0
9-MD-10460	9"	0
10-MD-10460	10"	0
12-MD-10460	12"	2
14-MD-10460	14"	2
16-MD-10460	16"	2
18-MD-10460	18"	4
20-MD-10460	20"	4
22-MD-10460	22"	4
24-MD-10460	24"	5
27-MD-10460	27"	6
30-MD-10460	30"	6
36-MD-10460	36"	6
42-MD-10460	42"	8
48-MD-10460	48"	8

with FH-205 Pilot

LBS	2 1/2" PN	2 5/8" PN
171	552375	100049
170	552380	100107
195	552385	100165
	552390	100224
	552395	100282
	552400	100359
350	552405	100441
	552410	100523
	552415	100585
440	552420	100663
	552425	100725
	552430	100783
595	552435	100841
	552436	100899
	552437	100957

with P-1650 Pilot

LBS	2 1/2" PN	2 5/8" PN
191	100043	100051
109	100101	100109
215	100159	100167
	100218	100226
	100275	100284
	100350	100362
370	100431	100443
	100513	100525
	100579	100587
460	100653	100665
	100719	100727
	100777	100785
615	100835	100843
	100893	100901
	100951	100959

with TF-600 Pilot

LBS	2 1/2" PN	2 5/8" PN
171	100057	100058
170	100115	100116
195	100173	100174
250	100231	100232
	100289	100290
	100371	100372
350	100453	100454
	100535	100536
	100593	100594
440	100675	100676
	100733	100734
	100791	100792
595	100849	100850
	100907	100908
	100965	100966



*All dirt augers above include two 1652 outside gage teeth.

CARBIDE AUGERS | 104" Overall Length, 60" Flight



Item Description

ITEM	DIA	NO. 1656
8-MD-10460	8"	0
9-MD-10460	9"	0
10-MD-10460	10"	0
12-MD-10460	12"	2
14-MD-10460	14"	2
16-MD-10460	16"	2
18-MD-10460	18"	4
20-MD-10460	20"	4
22-MD-10460	22"	4
24-MD-10460	24"	5
27-MD-10460	27"	6
30-MD-10460	30"	6
36-MD-10460	36"	6
42-MD-10460	42"	8
48-MD-10460	48"	8

with FH-205C Pilot

LBS	2 1/2" PN	2 5/8" PN
171	100045	100053
170	100103	100111
195	100161	100170
235	100219	100227
265	100277	100285
305	100351	100364
350	100434	100445
385	554547	100527
415	100582	100589
440	554549	100667
	100721	100729
	100779	100787
595	100837	100845
	100895	100903
	100953	100961

with P-1656 Pilot

LBS	2 1/2" PN	2 5/8" PN
191	100047	100055
109	100105	100113
215	100163	100172
	100222	100230
		100288
	100353	100366
370	100435	100447
	100517	100529
	100583	100591
460	100657	100669
	100723	100731
	100781	100789
615	100839	100847
	100897	100905
	100955	100963

*All dirt augers above include two 1658 outside gage teeth.

ROCK AUGERS | 104" OAL, 60" Flight

Item Description

ITEM	DIA	NO. SL02	LBS	2 1/2" PN	2 5/8" PN
16-MD-10460	16"	8		100357	100369
18-MD-10460	18"	10	370	100439	100451
20-MD-10460	20"	10		100521	100533
24-MD-10460	24"	12	506	100661	100673



Additional sizes available by contacting Pengo Customer Service at 800.599.0211.

UTILITY AUGERS

UTILITY AUGERS



PARTS | Pilot Bits

Pengo Pilots and Teeth are rated for drilling conditions that may or may not be applicable to your power source. Refer to the soil chart listed on page 2 of the Utility Catalog to determine which tooth type is right for the job.

ITEM		LBS	PART NO.
FH-205		2.7 LBS	157382
TF-600		8.5 LBS	137357
P-1650		8.5 LBS	131726
FH-205C		3 LBS	132260
P-1656		24 LBS	131727
RCP 6.5 Bullet		18 LBS	132116

RCP Pilot Includes 5 SL-02 Teeth and CP-18

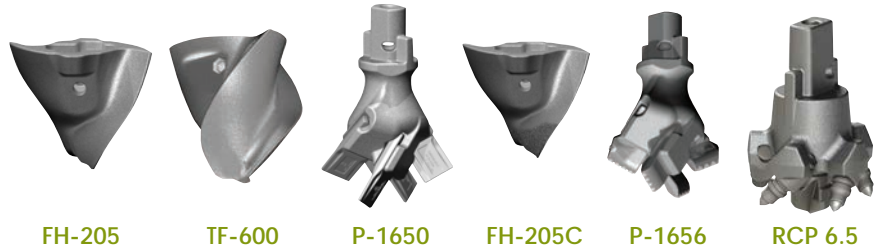

The RCP 6.5 Pilot uses the above Center Point 18. A Center Point 16 is also available.



PARTS | Fas-N-Lok® Teeth

ITEM		LBS	PART NO.
1650 Dirt		.5 LBS	140200
1851 Dirt		.5 LBS	140017
1652 Gage		.5 LBS	140020
1652 HF		.6 LBS	140086
1656		.6 LBS	140005
1658 Gage		1 LBS	140006
RB56		.4 LBS	140022
RB58		.4 LBS	140015



Fas-N-Lok® Teeth are manufactured with vulcanized rubber attached to the inside of the tooth, thus eliminating the need for RubRLok.

PARTS | Concial Teeth

ITEM		LBS	PART NO.
SL-02	.87 Shank Dia.	.6 LBS	850031
S-387-BF		.4 LBS	850030

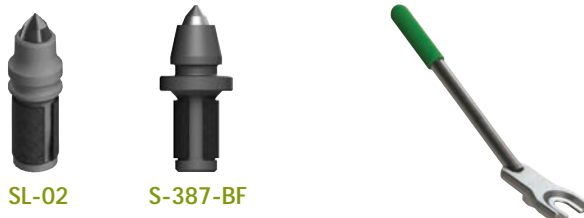

C123 Puller
Use with .86 shank size conical teeth
LBS | 3
PN | 134091

TRIDENT® SERIES | Holder and Teeth

One Holder, Three Teeth for Pengo Utility augers



Conical Tooth

Non-Rotating Tooth

Non-Rotating Wedge Tooth

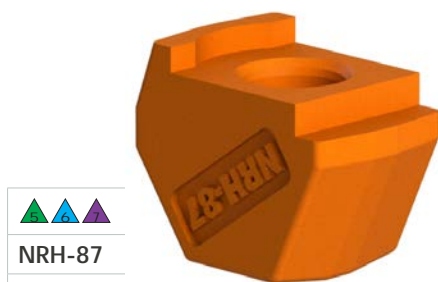

NRH-87
Fits .87" shank tooth
LBS | .56 ea.
PN | 990087



SL-02 Tooth
.87" shank
LBS | .56 ea.
PN | 850031

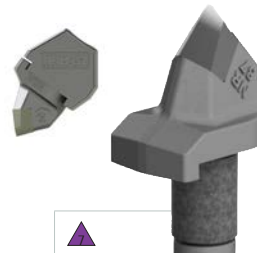

NR-87 Tooth
.87" shank
LBS | .99 ea.
PN | 990094



NRW-87 Tooth
.87" shank
LBS | 1.33 ea.
PN | 990100

UTILITY AUGERS



PARTS | MD Boring Heads

To Install: The MDOBH has an extended ramp on one side for welding to flight edge. Weld completely around center shaft and flight edge using a low hydrogen rod.

ITEM	DIA	NO. 1851	LBS	PN
8-MDOBH	8"	0	41	552005
9-MDOBH	9"	0	42	552010
10-MDOBH	10"	0	47	552015
12-MDOBH	12"	2	64	552025
14-MDOBH	14"	2	60	552030
16-MDOBH	16"	2	61	552035
18-MDOBH	18"	4	73	552040
20-MDOBH	20"	4	75	552045
22-MDOBH	22"	4	78	552050
24-MDOBH	24"	5	95	552055
26-MDOBH	26"	6	105	552060
27-MDOBH	27"	6	109	552065
30-MDOBH	30"	6	121	552070
36-MDOBH	26"	6	140	552075
42-MDOBH	42"	8	160	552076
48-MDOBH	48"	11	180	552077

Boring Head Kits Include: Shank Plates, PA-183L Pilot Bit Adapter, FH-205 Pilot, two 1652 and 1851 Teeth Series Fas-N-Lok® Teeth, nuts and bolts.



Pengo's Quick Ship Auger Program

HOW IT WORKS: 1. Select any ONE size auger from the list below. 2. Place your order by 12:00pm CST with your Pengo Customer Service Representative and be sure to reference P.D.Q. when ordering. 3. Auger(s) will ship by the end of the day to your chosen location.

TF-600 1851 and 1652 Fas-N-Lok® Teeth

ITEM	DIA	NO. 1656	LBS	2 1/2" PN	2 5/8" PN
18-MD-10460	18"	4	350	103312	100454
20-MD-10460	20"	4	385	103319	100536
22-MD-10460	22"	4	415	103326	100594
24-MD-10460	24"	5	440	103331	100676

FH-205C Pilot, 1656 and 1658 Fas-N-Lok® Teeth

18-MD-10460	18"	4	350	103313	100445
20-MD-10460	20"	4	385	103320	100527
22-MD-10460	22"	4	415	103327	100589
24-MD-10460	24"	5	440	103332	100667

RCP-6.5 Pilot and SL-02 Concial Teeth

18-MD-10460	18"	4	350	100439	100451
20-MD-10460	20"	4	385	100521	100533
24-MD-10460	24"	5	440	100661	100673

NOTE: Only one auger per size, per order will ship same day. Standard transit lead time applies to destination. Applies only to augers listed above. H-250 and H-262 Augers will be shipped with dish welded to auger.

SCREW ANCHOR TOOL

The SAT-85 is used for installing and removing anchors, without having to remove the auger. Slip the SAT-85 over the pilot, lock, and you are ready to attach your anchor.



SAT-85
LBS 17
PN 157533

REPLACEMENT PARTS for SAT-85

U-BOLT	157534
NUT	131683

CAUTION: The SAT-85 is for installation of anchors. You may use it to remove anchors as long as the u-bolt is securely in place. Failure to meet these precautions may cause safety hazards.

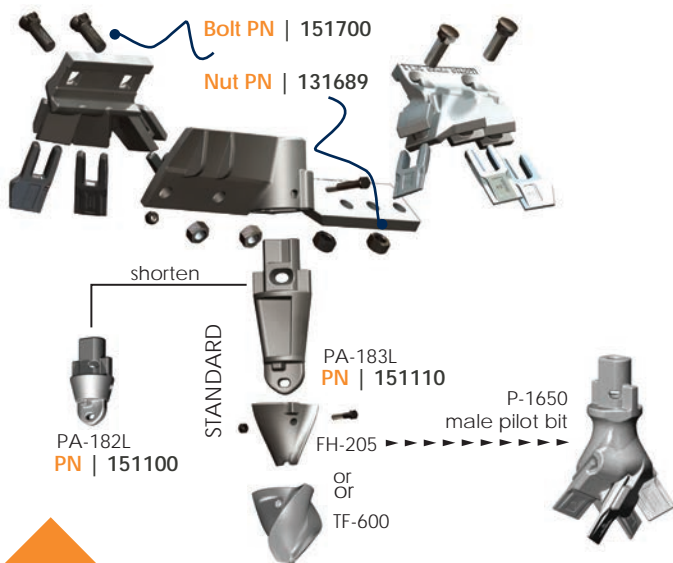

MD BORING HEAD

PENGO Utility Augers provide an abundance of drilling options. The above diagram depicts a typical Pengo dirt auger boring head with standard teeth and pilot bits. These boring heads provide many options depending on your drilling conditions.

UTILITY STEP ROCK



104" OAL

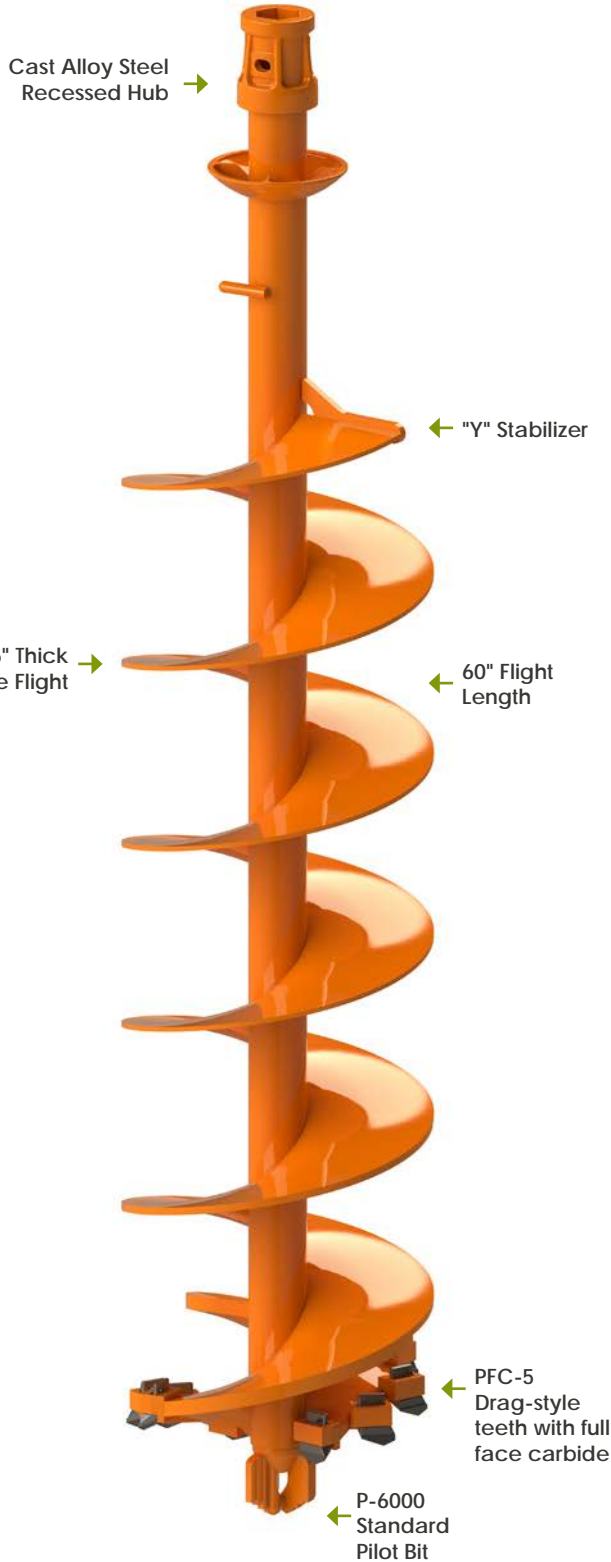

CONNECTIONS



AUGER DIAMETERS



CUT DIAMETER

Cut diameter is 1 1/2" larger than auger diameter.

DRILLING SOIL CONDITIONS:

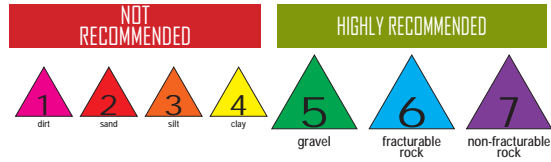

Pengo's Step Rock auger is specifically designed to overcome highly abrasive, non fracturable drilling applications. Featuring the same industry leading features of all Pengo Utility Augers, the Step Rock auger offers a recessed hub for added stability, seam welds for increased life cycle performance, our Patent-Pending flight stabilizer gusset and a high yield 4"OD center shaft. In addition, the Step Rock auger features a P-6000 API threaded pilot bit with PFC drag style teeth for highly abrasive soil in hard rock.

UTILITY STEP ROCK

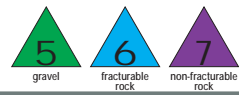

AUGERS | 104" Overall Length

ITEM	DIA	NO. TEETH	LBS	2" HEX	2 1/2" HEX	2 5/8" HEX
9-MDR-10460	9"	4	174	101100	554330	101101
10-MDR-10460	10"	4	183	101102	554331	101103
12-MDR-10460	12"	4	217	101104	554332	101105
14-MDR-10460	14"	4	244	101106	554333	101107
16-MDR-10460	16"	4	298	101108	554320	101109
18-MDR-10460	18"	6	327	101110	554335	101111
20-MDR-10460	20"	8	344	101112	554321	101113
24-MDR-10460	24"	12	434	101114	554322	101115
30-MDR-10460	30"	16	560	101116	554338	101117
36-MDR-10460	36"	20	590	101118	554339	101119



PARTS | Pilot Bits



P-6000

Step Rock pilot with API connection; for use in hard, fracturable rock

LBS | 8

PN | 151275



PARTS | Teeth



PFC-5

Drag style carbide tooth for highly abrasive soil in hard rock

LBS | 1

PN | 140115



PFC-5H

Holder for PFC-5 drag style teeth

LBS | 1.5

PN | 157027



P-10 ROLL PIN

Use with PFC-5 Tooth to secure tooth to shank. 6mm X 20mm

LBS | .1

PN | 137610

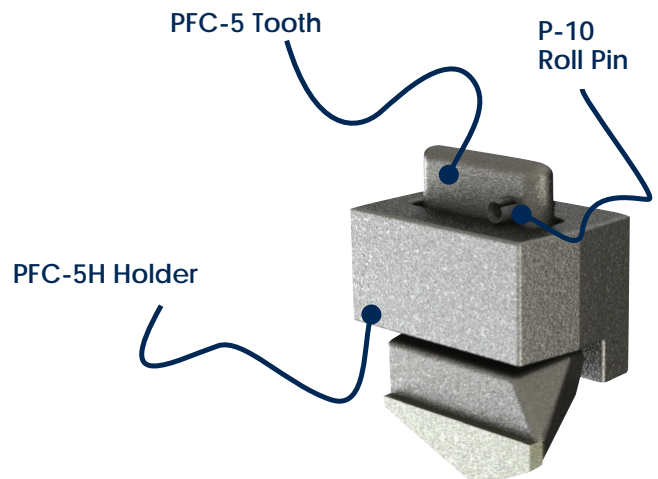

UTILITY ROCK RIPPER



104" OAL

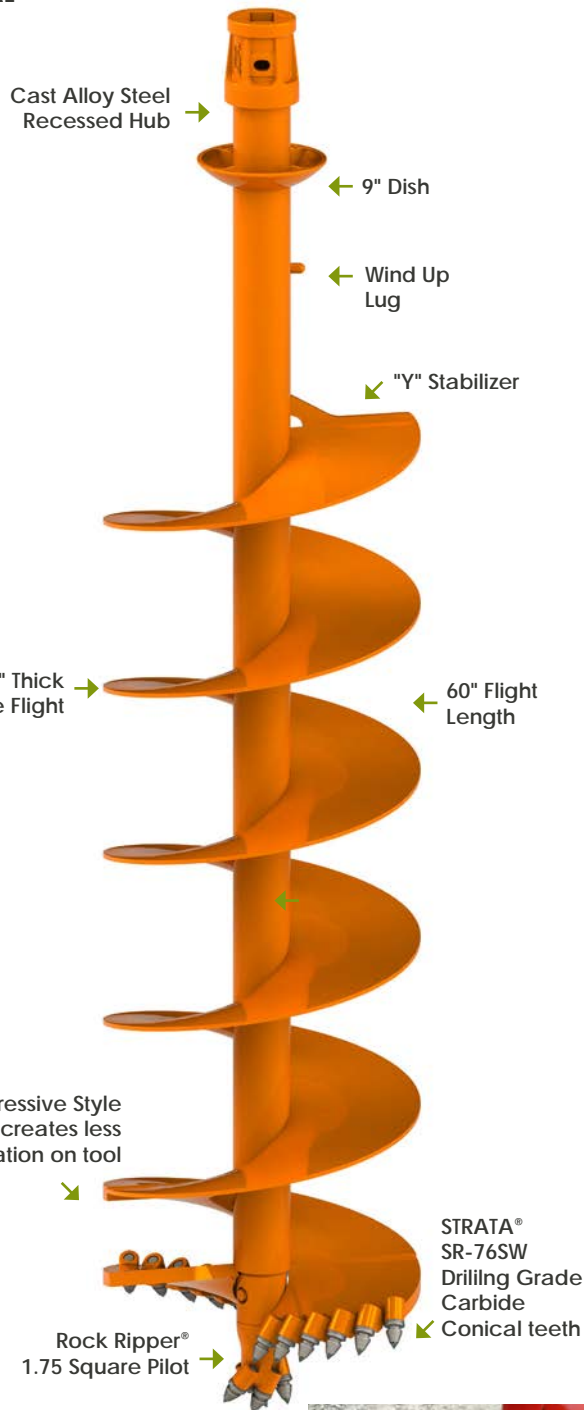

FACT: The redesigned progressive-style Rock Ripper® allows the auger to "bite" into the rock which reduces the vibration while it increases drilling production.



CONNECTIONS



AUGER DIAMETERS

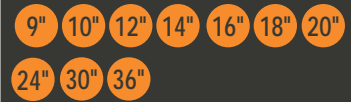

CUT DIAMETER

Cut diameter is 1 1/2" larger than auger diameter.

DRILLING SOIL CONDITIONS:

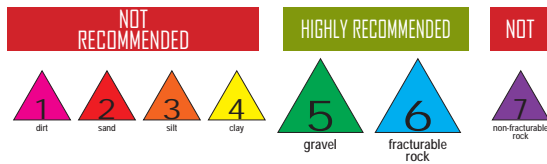

Pengo's Utility Rock Ripper® auger is a dedicated rock auger that overcomes gravel, fracturable, and non-fracturable drilling applications. Featuring a "progressive style" design, both pocket and teeth angles provide a smooth drilling action that minimizes vibration. All Rock Ripper® augers feature our exclusive Strata® series conical teeth, which offer drilling grade carbide that produces longer life cycles and greatly improves drilling efficiencies.

UTILITY ROCK RIPPER

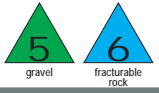

AUGERS | 104" Overall Length

ITEM	DIA	NO. TEETH	LBS	2" HEX	2 1/2" HEX	2 5/8" HEX
9-MRR-10460	9"	8	200	101150	133600	101151
10-MRR-10460	10"	9	225		134705	
12-MRR-10460	12"	10	250	101152	133601	101153
16-MRR-10460	16"	13	300	101154	133602	101155
18-MRR-10460	18"	14	340	101156	133603	101157
20-MRR-10460	20"	16	360	101158	133604	101159
22-MRR-10460	22"	17	390		101679	102898
24-MRR-10460	24"	19	420	101160	133605	101161
30-MRR-10460	30"	23	470	101162	133606	101163
36-MRR-10460	36"	27	500	101164	133615	101165



PARTS | Pilot Bits



ROCK RIPPER



RRP 1.75 SQ

Rock pilot for use in hard, fracturable rock

LBS | 15

PN | 137208

Use 1.75SQ Adapter PN | 137203

THE NUTS & BOLTS:

Included with the RRP 1.75 SQ Pilot. When purchased individually, this pilot ships with four STRATA® SR-76SW conical teeth.

PARTS | Teeth



Strata Drilling Grade Conical Teeth were developed by Pengo for the Drilling industry.

STRATA



STRATA® SR-76SW

LBS | .7

PN | 850035



SRL08

LBS | .5

PN | 990021

P-10 Pocket

.86 Shank pocket for PRL-08 and SR-76SW Conical Teeth

LBS | .8

PN | 990043

ACCESSORIES:

To prevent carbide on conical teeth from breaking, Pengo highly recommends using a soft hammer during installation of bullet teeth.



Soft Hammer

LBS | 3.5

PN | 137737



C30 Puller

LBS | 3

PN | 134090



C123 Puller

LBS | 3

PN | 134091

Due to the enlarged shoulder of the SR-76SW Strata® Tooth, the C30 Puller is recommended to aid in removing the tooth.

The S-RL08 Teeth will need the C123 Puller for removal.

MD QUICK CHANGE



104" OAL

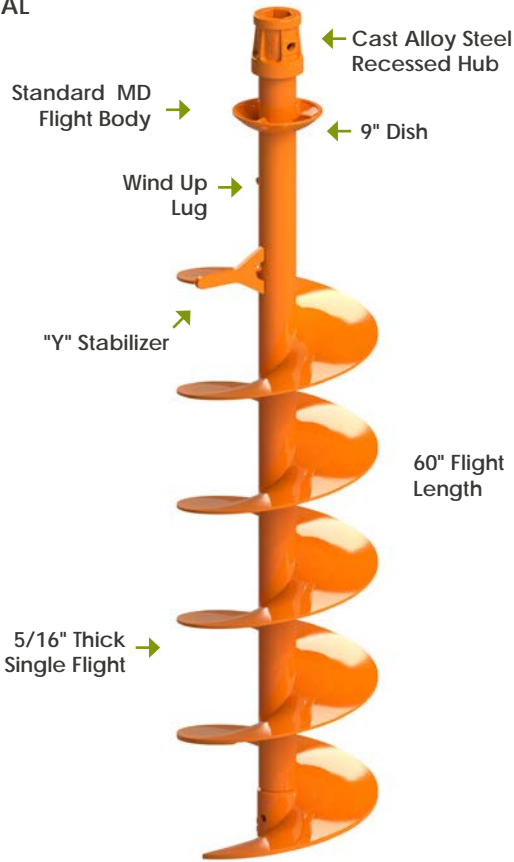

CONNECTIONS



AUGER DIAMETERS



CUT DIAMETER

Cut diameter is 1 1/2" larger than auger diameter.

DRILLING SOIL CONDITIONS:



AVAILABLE OPTIONS:

- 1. **Standard Dirt**
FH-205 Pilot, 1851 and 1652 Fas-N-Lok™ Teeth or TF-600 Pilot, 1851 and 1652 Teeth
- 1a. **Carbide**
FH-205C Pilot, 1656 and 1658 Fas-N-Lok™ Teeth
- 2. **Step Rock**
P-6000 Pilot and PFC-5 Drag Style Tooth
- 3. **Rock Ripper®**
RRP 1.75 Pilot and SR-76SW STRATA® Conical Teeth



When faced with a variety of drilling conditions, Pengo's MD quick change system is the most versatile solution in the market. Just select your flight body and choose between dirt, rock, or step rock heads. Choose all three and you're prepared to handle any drilling condition with a single tool.

MD QUICK CHANGE



FLIGHT SECTIONS | 104" OAL

ITEM	DIA	LBS	2" HEX PN	2 1/2" HEX PN	2 5/8" HEX PN
8-FMD-10460	8"		101016	556575	101017
9-FMD-10460	9"		101018	556580	101019
10-FMD-10460	10"		101020	556585	101021
12-FMD-10460	12"		101022	556595	101023
14-FMD-10460	14"		101024	556600	101025
16-FMD-10460	16"		101026	556605	101027
18-FMD-10460	18"		101028	556610	101029

ITEM	DIA	LBS	2" HEX PN	2 1/2" HEX PN	2 5/8" HEX PN
20-FMD-10460	20"		101030	556615	101031
22-FMD-10460	22"		101032	556620	101033
24-FMD-10460	24"		101034	556625	101035
26-FMD-10460	26"		101036	556630	101037
27-FMD-10460	27"		101038	556635	101039
30-FMD-10460	30"		101040	556640	101041
36-FMD-10460	36"		101042	556645	101043

HEADS | Dirt and Carbide

ITEM	DIA	1851 TEETH	FH-205 PN	TF-600 PN	FH-205C PN
POMDH-8	8"	0	556500	101579	101044
POMDH-9	9"	0	556505	101580	101045
POMDH-10	10"	0	556510	101581	101046
POMDH-12	12"	2	556520	101582	101047
POMDH-14	14"	2	556525	101583	101048
POMDH-16	16"	2	556530	101584	101049
POMDH-18	18"	4	556535	101585	101050
POMDH-20	20"	4	556540	101586	101051
POMDH-22	22"	4	556545	101587	101052
POMDH-24	24"	5	556550	101588	101053
POMDH-26	26"	6	556555	101589	101054
POMDH-27	27"	6	556560	101590	101055
POMDH-30	30"	6	556565	101591	101056
POMDH-36	36"	6	556570	101592	101057

*All dirt heads include two 1652 outside gage teeth and carbide heads include two 1658 outside gage teeth and 1656 teeth.

OPTION 1



FH-205 Pilot
LBS | 2.7
PN | 157382

1851 Tooth
LBS | .5
PN | 140017

OPTION 1A



FH-205C Pilot
LBS | 2.1
PN | 132260

TF-600
LBS | 8.5
PN | 137357

1652 Tooth
LBS | .5
PN | 140020

1656 Tooth
LBS | .7
PN | 140005

1658 Tooth
LBS | 1
PN | 140006

HEADS | Step Rock and Rock

ITEM	DIA	PFC-5 TEETH	P-6000 PN
POMDR-9	9"	4	554680
POMDR-10	10"	4	554687
POMDR-12	12"	4	554681
POMDR-14	14"	4	554688
POMDR-16	16"	6	554682
POMDR-18	18"	8	554683
POMDR-20	20"	8	554684
POMDR-24	24"	12	554685
POMDR-30	30"	16	554686
POMDR-36	36"	18	554689

OPTION 2



P-6000
LBS | 8
PN | 151275

PFC-5
LBS | 1
PN | 140115

ITEM	DIA	SR76SW TEETH	RRP-1.75 PN
POMRR-9	9"	8	133607
POMRR-10	10"	9	133621
POMRR-12	12"	10	133608
POMRR-14	14"	12	102095
POMRR-16	16"	13	133609
POMRR-18	18"	14	133610
POMRR-20	20"	16	133611
POMRR-24	24"	19	133612
POMRR-30	30"	23	133613
POMRR-36	36"	27	133620

OPTION 3



RRP-1.75 Sq
LBS | 15
PN | 137208

SR-76SW
LBS | .56
PN | 850035

PRESSURE DIGGER DIRT



30" and 36" OAL



CONNECTIONS		AUGER DIAMETERS	
SQUARE	2 1/2"	9"	12" 16" 18" 20" 24" 28"
SQUARE	3"	30"	36" 42" 48" 60" 72"
SQUARE	4"		

CUT DIAMETER
True Cut diameter is equal to the auger diameter.

DRILLING SOIL CONDITIONS:



The Pengo PDD augers feature a cast heat treated head that provides superior wear and performance compared to normal fabricated augers. In addition the cast head is field repairable with standard welding techniques, utilizing low hydrogen welding rods and no pre or post heating requirement.

These rugged augers feature a 1 1/2" thick lead flight followed by a 1" thick formed trailing flight. The 10" cut three-flute TriFlow® pilot provides outstanding ground penetration. PDD bits are equipped with Pengo's exclusive Fas-N-Lok® teeth, making replacement quick and easy.

PRESSURE DIGGER DIRT



AUGERS | 30" Overall Length

ITEM	DIA	NO. 2070 TEETH	NO. 2072 TEETH	LBS	S-250 PN	S-300 PN	S-350 PN	S-400 PN
16-PDD-30	16"	0	2			102945	136338	102991
18-PDD-30	18"	1	2		102535	102946	136339	102992
20-PDD-30	20"	2	2			102947	136340	
24-PDD-30	24"	3	2		102522	136356	136341	102993
28-PDD-30	28"	4	2				102593	102994
30-PDD-30	30"	4	2			136357	136343	
36-PDD-30	36"	6	2		102819	102429	136344	102995
42-PDD-30	42"	8	2				136345	102996
48-PDD-30	48"	10	2		102426	102415	136346	102997
60-PDD-30	60"	18	2				136347	

CAST DIRT HEAD

For Repair of your PDD Auger

Weld-On head for quick field repair.



The PENGU Pressure Digger Dirt Augers are built with a heat-treated cast dirt head. These cast heads are high strength and low maintenance.

ITEM	DIA	NO. TEETH	LBS	PN
DIRT 16	16"	1	120	752810
DIRT 18	18"	1	135	752811
DIRT 20	20"	2	153	752812
DIRT 24	24"	3	180	752813
DIRT 36	36"	6	270	752814
DIRT 48	48"	8	345	752815

All Include two 2072 outside gage teeth and 2070 inside teeth.

PARTS | Pilot Bits



Heavy-duty dirt pilot with 2 1/2" square stem for easy installation.

THE NUTS & BOLTS:

Included with the TF-1000 Pilot Bit assembly.

TF-1000
LBS 43
PN 137348
Uses S-250 Pilot Adapter
PN 151598

PARTS | Fas-N-Lok® Dirt Teeth



2070 Dirt
LBS 2
PN 140002



2072 Dirt
LBS 2.3
PN 140000

FAS-N-LOK® Dirt Teeth have vulcanized rubber attached to tooth thus making installation quick and easy.

PARTS | Fas-N-Lok® Carbide Teeth



2077
LBS 2.3
PN 140003

2078
LBS 2.4
PN 140004

Drift Punch
LBS .8
PN 137750



Use the Drift Punch for easy removal.

PRESSURE DIGGER ROCK



30" and 36" OAL

CONNECTIONS		AUGER DIAMETERS	
SQUARE	2 1/2"	9"	12" 16" 18" 20" 24" 28"
SQUARE	3"	30"	36" 42" 48" 60" 72"
SQUARE	3 1/2"		
SQUARE	4"	CUT DIAMETER <i>True Cut diameter is equal to the auger diameter.</i>	

DRILLING SOIL CONDITIONS:

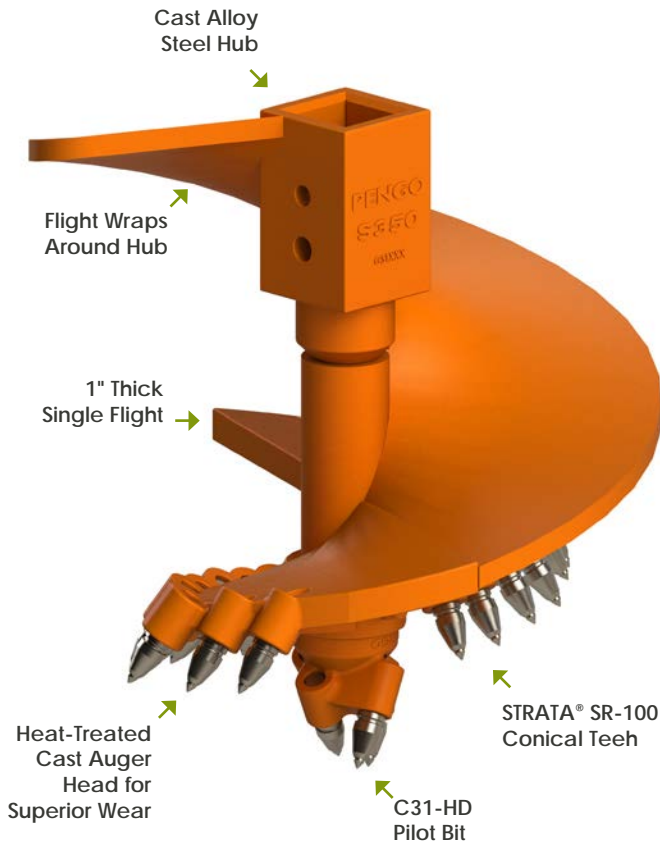

FACT: The Pengo® PDR is great for use in undesirable rocky conditions and in areas with minimum ground clearance.

Pengo® True Cut PDR augers are made with thick, heat-treated cast alloy heads and Pengo's own STRATA® SR-100 conical teeth. The cast heat treated head provides superior wear and performance compared to normal fabricated augers. In addition the cast head is field repairable with standard welding techniques, utilizing low hydrogen welding rods and no pre- or post-heating requirement.

PRESSURE DIGGER ROCK

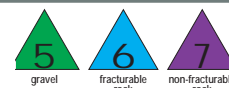

AUGERS | 30" Overall Length

ITEM	DIA	NO. TEETH	LBS	S-250 PN	S-300 PN	S-350 PN	S-400 PN
9-PDR-30	9"	6		102401		101005	
10-PDR-30	10"	6		102941	102889		
12-PDR-30	12"	8		101975		101006	
16-PDR-30	16"	8		102460	102365	101007	
18-PDR-30	18"	9		101976		101008	
20-PDR-30	20"	11		102386	102603		102069
24-PDR-30	24"	12				101009	
30-PDR-30	30"	17		102450		101010	102070
36-PDR-30	36"	20			101713	101011	
42-PDR-30	42"	24		102957	102185	101012	
48-PDR-30	48"	28				101013	
60-PDR-30	60"	37			102361	101014	
72-PDR-30	72"	44				101015	

CAST ROCK HEAD

Weld-On head for quick field repair.

For Repair of your PDR Auger



The PENGU Pressure Digger Rock Augers are built with a heat-treated cast dirt head. These cast heads are high strength and low maintenance.

ITEM	DIA	NO. TEETH	LBS	PN
ROCK 16	16"	8	70	752800
ROCK 18	18"	9	77	752801
ROCK 20	20"	11	85	752802
ROCK 24	24"	12	102	752803
ROCK 30	30"	17	127	752804
ROCK 36	36"	20	153	752805
ROCK 42	42"	24	180	752806
ROCK 48	48"	28	204	752807

PARTS | Pilot Bits

C31HD 8.5
LBS | 30
PN | 135913
 Uses S-250 Pilot Adapter
PN | 151598



PILOT BIT ASSEMBLY:

The C31HD includes four SR-100 STRATA® Conical teeth.

PINS and WASHERS:

Included with the Pilot bit assembly.

PARTS | Conical Teeth

STRATA® SR-100
LBS | 1.1
PN | 850023



STRATA
 Large Carbide Tip for extreme hard rock drilling

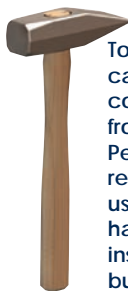

To prevent carbide on conical teeth from breaking, Pengo highly recommends using a soft hammer during installation of bullet teeth.

S31-HD
LBS | 1.1
PN | 850037



P30 Pocket
LBS | 2.6
PN | 990001

Soft Hammer
LBS | 3.5
PN | 137737

S31
LBS | 1.3
PN | 850026



TRIDENT® SERIES | Holder and Teeth



NRH-100
 Fits 1" shank tooth
LBS | 2.4 ea.
PN | 990088



One Holder, Three Teeth for Pengo PDR augers!

Conical Tooth

Non-Rotating Tooth

Non-Rotating Wedge Tooth

SR-100
LBS | .56 ea.
PN | 850023



NR-100
LBS | .99 ea.
PN | 990092



NRW-100
LBS | 1.33 ea.
PN | 990098



UTILITY SHANK PLATES and KITS



SHANK PLATES | Bolt on Shanks for Utility Augers

ITEM	DIA	TEETH	MM	BOLTS	LBS	PN
810X	8"-10"	1	203	1	5.5	553997
12X	11"-13"	2	279	1	11	553998
145X	14"	2	356	2	10.9	553999
16X1	16"	2	406	2	9.5	554000
16X2	16"	2		2	9.5	554001
18X1	18"	3	457	2	14	554002
18X2	18"	3		2	14	554003
20X-1	20"	3	508	2	14	554004
20X-2	20"	3		2	14	554005
22X-1	22"	3	559	3	16	554006
22X-2	22"	3		3	16	554007
24X-1	24"	3	610	3	18	554008
24X-2	24"	4		3	18	554009
267X-1	26"-27"	4	620	4	20.5	554010
267X-2	26"-27"	4		4	20.5	554011
30X-1	30"	4	762	4	25.5	554014
30X-2	30"	4		4	25.5	554015
36X-1	36"	4	914	4	32	554016
36X-2	36"	4		4	32	554017

Available in sizes from 8" to 36"



Nuts and Bolts included

Use to repair worn shanks on MD dirt augers

How To Determine which shank you need. Example - 20X-1 and 20X-2.

Order one of each if both shanks need to be replaced.

If only need to replace one shank, the end-user needs to provide number from either the shank that he is replacing or the one he still has. If your customer provides you with the shank he still has, i.e. 20X-1, then you will need to order the 20X-2 shank.

SHANK KIT | Bolt on Rock Shank Kits for Utility Augers

ITEM	DIA	TEETH	LBS	PN
RSK-16	16"	13	43.5	554230
RSK-18	18"	15	56.3	554231
RSK-20	20"	15	51.5	554232
RSK-24	24"	17	56.5	554233

SHANK & PILOT ROCK KIT

Includes: Rock Shank Plates, RCP-6.5 Pilot and SL-02 Conical Teeth. These shank plates bolt on to MDOBH heads and allows for drilling in fracturable rock.

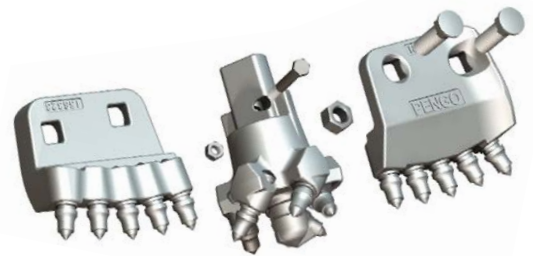

SHANK KIT | Bolt on Rock Shanks for Utility Augers

ITEM	DIA	TEETH	LBS	PN
RSP-16	16"	4	12.5	554240
RSP-18	18"	5	15	554241
RSP-20	20"	5	16.5	554242
RSP-24	24"	6	19	554243

PENGO Style Rock Shanks

Includes: Rock Shank Plates, and SL-02 Conical Teeth. Numbers below are per shank. These shank plates bolt on to MDOBH heads and allows for drilling in fracturable rock.

UTILITY ADAPTERS and HUBS



ADAPTER HUBS | For Utility Augers

FEMALE	X	MALE	LBS	PN
H-200	X	H-250	22	132609
H-200	X	H-262	23	133379
H-250	X	H-200	30	132419
H-250	X	H-262	26	136466
H-262	X	H-200	26	133938
H-262	X	H-250	30	132702
H-300	X	H-200	22	132608
H-300	X	H-250	30	132086
H-300	X	H-262	30	131263
S-250	X	S-300	41	133914
S-350	X	S-250	66	132938



Listed are just a few of our most requested adapter sizes. We offer over one hundred different sizes, so please contact PENGO if you are in need of something other than what is listed above.

HUBS | For Utility Auger Repair

ITEM	DESC	LBS	PN
H-200 U	2" Universal	10.5	154121
H-250	2 1/2" Slotted	19.7	154141
H-262	2 5/8" Slotted	17.6	154151
H-225	2 1/4" Cast	12.5	154160
H-300	3" Cast	21	154205
S-250	2 1/2" Cast	21	154010
S-300	3" Cast	40	154020
S-350	3 1/2" Cast	52.3	154030



Listed are the common Utility auger replacement hubs. For additional items please contact our sales department

ACCESSORIES | Storage

ITEM	LBS	PN
10" 1345-3.75 DISH	6.8	151735
10" CUST - 4" ID DISH	7	132875
8" 1345-3.00 DISH	4.5	151732
8" 1345-3.75 DISH	4.5	151731
2 3/8" API, 3 1/2" OD BOX THREAD	6.1	132191
2-3/8" API, 4" OD BOX THREAD	7	151193
REACH ALL WIND-UP	0.8	157704

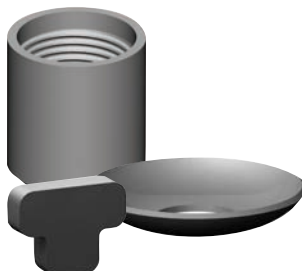

UTILITY EXTENSIONS



EXTENSION | Telescoping

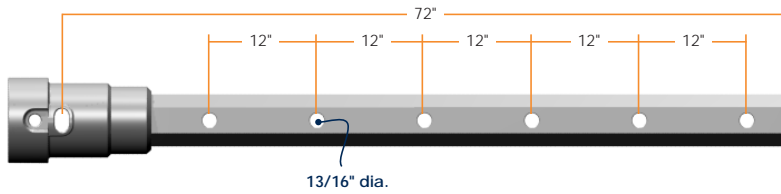

ITEM	DESCRIPTION	LBS	PN
HE20-12	2" HEX X 12"	22	557142
HE20-24	2" HEX X 24"	34	557143
HE20-36	2" HEX X 36"	46	557144
HE20-48	2" HEX X 48"	58	557145
HE20-60	2" HEX X 60"	70	557146
HE20-72	2" HEX X 72"	82	557147
HE25-12	2 1/2" HEX X 12"		557126
HE25-24	2 1/2" HEX X 24"		557162
HE25-36	2 1/2" HEX X 36"		557128
HE25-48	2 1/2" HEX X 48"		557129
HE25-60	2 1/2" HEX X 60"		557130
HE25-72	2 1/2" HEX X 72"		557163
HE26-12	2 5/8" HEX X 12"		557119
HE26-24	2 5/8" HEX X 24"		557120
HE26-36	2 5/8" HEX X 36"		557121
HE26-48	2 5/8" HEX X 48"		557122
HE26-60	2 5/8" HEX X 60"		557160
HE26-72	2 5/8" HEX X 72"		557161
	H-250F X H-262M X 72"		557172
	H-262F X H-250M X 72"		557170

Listed are the common MD telescoping extensions. For additional items please contact our sales department.



EXTENSION BARS | No Hubs, with Holes

ITEM	LBS	PN
2" HEX X 72" STD		137570
2-5/8" HEX X 72" STD		137572
H-250 X 72" STD		137571

COUPLERS | Hex

ITEM	DESCRIPTION	A	L	LBS	PN
H-200-C	2" x 2"	3"	8"	13	553400
H-250-C	2 1/2" x 2 1/2"	5"	8"	22	553402
H-262-C	2 5/8" x 2 5/8"	5"	8"	21	553403

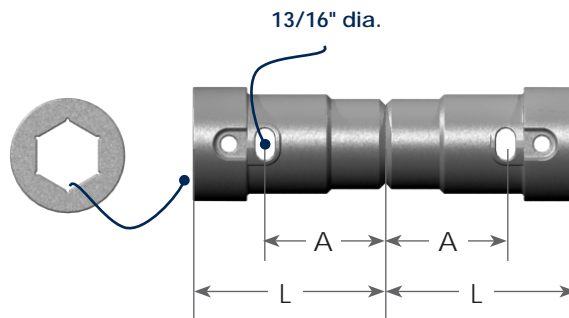

PENGO UTILITY AUGERS

800.599.0211

UTILITY_Q41719