

AGILA

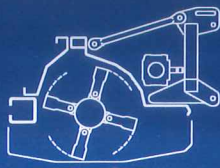

UNIKA

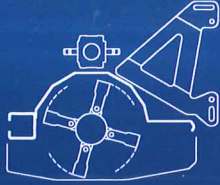

FALC[®]



50-120 HP

FALC

I TRINCIA
F BROYEUR
GB SHREDDER

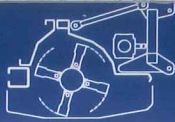

AGILA

I SOLO POSTERIORE
F SEULEMENT ARRIERE
GB ONLY REAR

D NUR HINTER
E SOLAMENTE POSTERIOR
РУС ТОЛЬКО ЗАДНИЙ

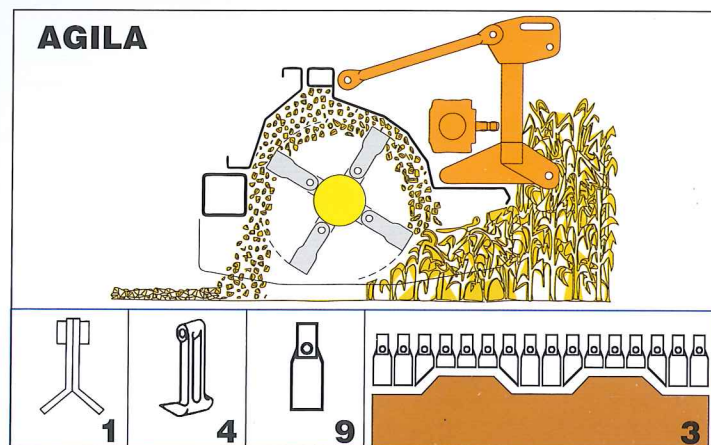

I Attacco con spostamento idraulico
F Attelage avec déplacement hydraulique
GB Linking with hydraulic shifting

D Anschluß mit hydraulik Vershub
E Enganche con desplazamiento hidráulico
РУС С гидравлическим смещением



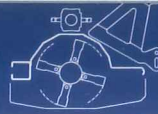

- I** ANTERIORE O POSTERIORE
- F** ANTERIEUR OU ARRIERE
- GB** FRONT OR REAR

- D** VORDER ODER HINTER
- E** ANTERIOR O POSTERIOR
- PYC** ПЕРЕДНИЙ ИЛИ ЗАДНИЙ



- I** G/M del rotore
- F** T/M du rotor
- GB** Rotor's RPM
- D** Rotor U/M
- E** R/M de rotor
- PYC** Об/Мин ротора

- I** Velocità periferica dei coltelli
- F** Vitesse périphérique des couteaux
- GB** Tip speed of blades
- D** Messersumfangsgeschwindigkeit
- E** Velocidad periferica de las cuchillas
- PYC** СКОРОСТЬ ВРАЩЕНИЯ НОЖЕЙ

AGILA - UNIKA

1600	N° 2132
1800	N° 2132
2100	N° 2132
2300	N° 2132
2500	N° 2132
2700	N° 1910

AGILA - UNIKA	m/sec.	inches/sec.
1600-1800-2100	64	2520
2300-2500	68	2677
2700	61	2402

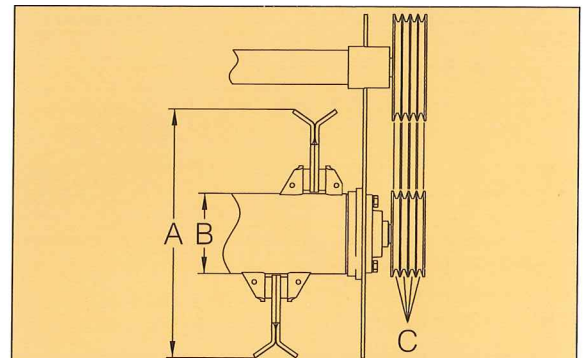

		AGILA - UNIKA
A	Ø mm 575 Ø mm 611	1600-1800-2100 2300-2500-2700
B	Ø mm 159x10 Ø mm 193,7x10	AGILA - UNIKA 1600-1800-2100 2300-2500-2700
C	n. 3 n. 4	AGILA - UNIKA 1600-1800 2100-2300-2500-2700





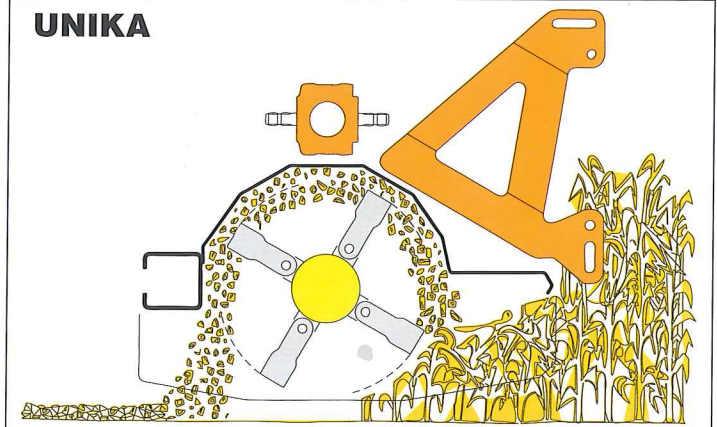



UNIKA

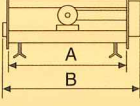

AGILA - UNIKA

I dati tecnici, le caratteristiche e le illustrazioni sono indicative e non impegnano il costruttore. - Les données techniques, les caractéristiques et les illustrations sont indicatives et ne compromettent ni le constructeur. - Die technische Angaben, die Merkmale und die Bilder sind weisend und verbinden nicht den Hersteller. - Los datos técnicos, las características y las ilustraciones son indicativas y no comprometen al constructor. - Технические характеристики, спецификации и иллюстрации носят ознакомительный характер и не являются обязательными для производителя.

AGILA UNIKA							 AGILA		 UNIKA		
	HP	P.T.O.	A mm.	B mm.	A inches	B inches	KG	LBS	KG	LBS	N.
1600	50 - 100	540	1581	1822	62,24	71,73	660	1455	656	1446	32
1800	50 - 100	540	1761	2002	69,33	78,82	706	1556	688	1517	36
2100	50 - 100	540	2121	2362	83,50	92,99	750	1653	751	1656	44
2300	50 - 120	540	2305	2546	90,75	100,24	910	2006	887	1955	48
2500	50 - 120	540	2485	2726	97,83	107,32	965	2127	926	2041	52
2700	50 - 120	540	2665	2906	104,92	114,41	1020	2249	968	2134	56

1 AGILA

- I** Macchina con barra posteriore e rullo
- F** Machine avec barre postérieure et rouleau
- GB** Machine with rear bar and roller
- D** Maschine mit hinterer Stange und Walze
- E** Máquina con barra trasera y rodillo
- PYC** Машина с задней панелью и валиком

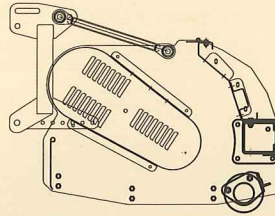

1 UNIKA

- I** Macchina con slitte regolabili
- F** Machine avec patins réglables
- GB** Machine with adjustable skids
- D** Maschine mit einstellbarem Kufenpaar
- E** Máquina con patines regulables
- PYC** Машина с регулируемыми лыжами

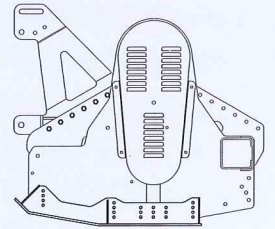

2 AGILA

- I** Macchina con barra posteriore e coppia ruote sterzanti
- F** Machine avec barre postérieure et couple de roues braquantes
- GB** Machine with rear bar and pair of steering wheels
- D** Maschine mit hinterer Stange und Steuerräderpaar
- E** Máquina con barra trasera y 2 ruedas girantes
- PYC** Машина с задней панелью и парой рулевых колес

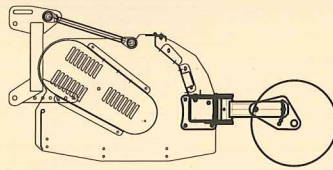

2 UNIKA

- I** Macchina con rullo
- F** Machine avec rouleau
- GB** Machine with roller
- D** Maschine mit Walze
- E** Máquina con rodillo
- PYC** Машина с валиком

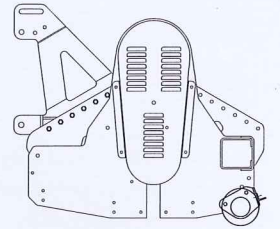

3 AGILA

- I** Macchina con rullo e lamiera di protezione
- F** Machine avec rouleau et tôles de protection
- GB** Machine with roller and guarding sheets
- D** Maschine mit Walze und Schutzbleche
- E** Máquina con rodillo y chapas de protección
- PYC** Машина с валиком и защитным металлическим листом

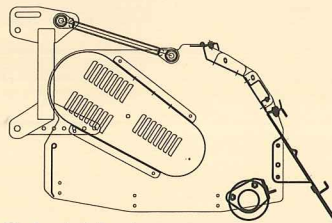

3 UNIKA

- I** Macchina con coppia ruote sterzanti
- F** Machine avec couple de roues braquantes
- GB** Machine with pair of steering wheels
- D** Maschine mit Steuerräderpaar
- E** Máquina con 2 ruedas girantes
- PYC** Машина с парой рулевых колес

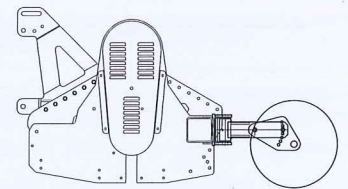

FALC - Via Proventa, 41 - 48018 FAENZA (ITALIA) - e-mail: info@falc.eu - www.falc.eu

Numero nazionale:

Tel. 0546 29050
Fax 0546 663986

International number:

Tel. +39 0546 29050
Fax +39 0546 663986

FALC®

