

USER AND MAINTENANCE MANUAL

Manufacturer: **FALC S.r.l.**
via Proventa n.41 - Faenza (Ravenna) - ITALIA -
Tel. +39 0546 29050
Fax +39 0546 663986
e-mail: info@falc.eu
www.falc.eu

Series: **Rotary tillers A – BS/BS Super – C1/CS – D – HD – EL – FL
GL – GSL – Kappa – Gamma/P – Cultiline – Reverse – RU –
Strip-Till**

Model: _____

Serial Number: _____

INDEX

- 1.1 CE conformity declaration
- 1.2 CE plate
2. Conditions of use
- 2.1 Technical data
- 2.2 Stability of the combined machine/tractor unit
3. Conditions for the operator
- 3.1. Connection of the rotary tiller to the tractor
- 3.2. Connection to the PTO shaft
- 3.3. Disconnection of the rotary tiller from the tractor
- 3.4. Rotary tillers CS-D-HD-EL-FL-GL-GSL-Cultiline: Gearbox with manual gears replacement
- 3.5. Rotary tillers KAPPA: gearbox with lever change
- 3.6. Adjustment of working depths
- 3.7. Adjustment of the rear guard
- 3.8. Rotary tillers EL-FL-GL-GSL-KAPPA-Strip-Till: use of the seeder attachment
- 3.9. Rotary tillers D-HD-EL-FL-GL-GSL-KAPPA-RU: use with trace breaker
- 3.10. Rotary tillers EL-FL-GL-GSL-KAPPA: use with subsoiler
4. Operation
5. Transport
6. Maintenance and repairs
7. Causes of possible malfunctions and relevant actions
8. Warranty
9. Norms to be followed for correctly ordering spare parts
10. Safety pictograms

NOTA BENE:

- **THIS MANUAL MUST ACCOMPANY EACH EXAMPLE OF THE ABOVE MENTIONED SERIES.**
- **IN ORDER TO ENSURE A COMPLETE UNDERSTANDING OF THE MACHINE'S CORRECT FUNCTIONING, THE USER MUST FULLY READ EACH SECTION OF THE MANUAL.**
- PARTICULARLY IMPORTANT NOTES REGARDING SAFETY ARE WRITTEN IN BOLD PRINT.
- ANY USERS WHO MUST CARRY OUT PARTICULAR OPERATIONS ON THE MACHINE FOR WHICH NO SPECIFIC INSTRUCTIONS HAVE BEEN SUPPLIED MUST DIRECTLY ASK OUR SALES OR TECHNICAL OFFICE.



1.1 CE CONFORMITY DECLARATION



Falc - cod. 2001 01/2010 - Inglese -

Min. Comm. Estero M RA 000637 - R.E.A. RA n. 111028 - Part. IVA 00963130398 - C.F. e Iscr. Reg. Impr. 00963130398 - Cod. Ident. C.E.E. IT 00963130398 - Cap. Soc. € 1.664.000 i.v.

CE CONFORMITY DECLARATION in accordance with 2006/42/CE directive and subsequent modifications

The undersigned Company

FALC S.r.l.

via Proventa n. 41 - Faenza (Ravenna) - ITALIA -

Declares on its own responsibility that the machine:

(Model)

(Serial number)

is in conformity with the Safety and Health Protection Essential Requirements of
the 2006/42/CE directive and subsequent modifications

Person authorized to compile the technical file:
Falc Srl – via Proventa n. 41 – Faenza (Ravenna) - Italia

Faenza (Ravenna) – ITALIA

On behalf of Falc S.r.l.
The President
Piero Zama

/ /



MEMBER

FALC s.r.l. - Via Proventa n. 41 - 48018 FAENZA (RA) - ITALIA
e-mail: info@falc.eu www.falc.eu

Numero Nazionale: ☎ 0546 29050 - Fax 0546 663986
International Number: ☎ +39 0546 29050 - Fax +39 0546 663986

Privacy: D.L. 196/2003 - La Falc srl, in qualità di titolare del trattamento, informa che i Vs. dati personali sono acquisiti, trattati e diffusi esclusivamente per finalità connesse allo svolgimento dei rapporti commerciali e/o precontrattuali e/o contrattuali di cui siete parte

1.2.CE PLATE

Every machine is equipped with an identification plate with the following details:

1. Manufacturer's brand and address
2. Machine model;
3. Machine serial number;
4. Year of manufacture;
5. CE marking.

FALC	(1)
VIA PROVENTA, 41 - FAENZA (RA) - ITALIA	
MOD. (2)	(5)
N° (3)	ANNO DI FABBRICAZIONE (4)
CE	

2. CONDITIONS OF USE

FALC rotary tillers are built to be coupled to an ideal tractor provided with a 3-point hitch and a cardan shaft transmission. The rotary tillers are used to refine the soil and prepare it for sowing.

EVERY OTHER USE OF THE ROTARY TILLER AND THE APPLICATION TO THE SAME OF ACCESSORIES NOT MANUFACTURED BY FALC IS TO BE CONSIDERED ILLEGAL AND NOT PERMITTED BY THE MANUFACTURER.

Do not:

- work with rotary tiller installed on the front of the tractor;
- allow unauthorised, unqualified and untrained personnel to use the machine;
- use the system in conditions other than those specified in these instructions for use (see chapter 4).

On some models of rotary tiller produced by FALC, it is possible to replace the traditional hoe rotor with a straight cutters rotor (Terraking) or with a toothed rotor (Rotoking)

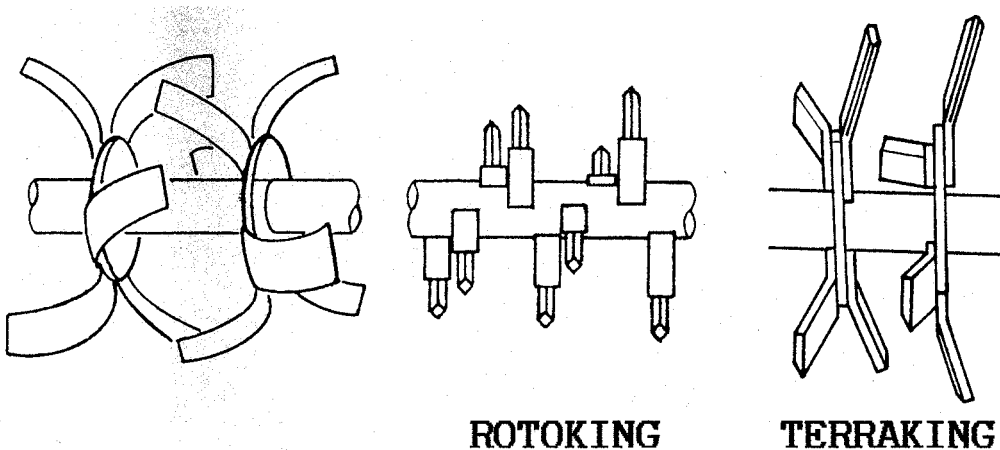

The use of the Rotoking rotor is recommended for particularly heavy, difficult or stony soils; the special shape of the tooth and its specific inclination make it so that even the hardest sods are "attacked" and do not escape the teeth in operation; breaks the ground, is ideal for the destruction of herbs cultivations or old lawns, breaks and buries stubble that remains after harvest and the waste of previous cultivations; does not cause the formation of the smooth impermeable layer; is ideal for working vineyards and fruit orchards in general.

Gamma Folding Rotary Tiller:

The folding rotary tillers has been designed to satisfy the requirements of subcontractors, of the large farming companies and for all those who generally have problems in transferring a large farming machine from one work place to another. In fact, in transport conditions, the total overall dimension is below 3 m. The opening and closing of the machine is achieved by the activation of 2 hydraulic cylinders connected to the tractor's gear case. The 2 cylinders are complete of blockage valve to give absolute safety during the opening and closing operations.

The safety valves on the lifting cylinders and the sequence valves which adjust the safety hooks must NOT absolutely be set by the user. The tempering of these valves can injure the security of the machine.

During the opening and closing operations of the power rotary tillers, the operator is obliged to ensure that no animals, persons or things are located within a range of 5 m around the machine.

The operator must not carry out any opening or closing operation of the rotary tiller if the previous condition has not been adhered to.

In order to “close” the rotary tillers, the operations are as follows:

- Stop the tractor on plane ground, disengage the power take-off, activate the handbrake, ease the rotary tillers on the ground by operating on the control of the 3rd point and turn the engine of the tractor itself off.
- Climb off the tractor, disconnect the Cardan shaft from the tractor's power take-off and place it in the appropriate support.

This operation is indispensable for tractors in which the PTO, when disengaged, is completely locked, and hence does not allow for small rotations.

Attention: the company FALC is not responsible of any eventual damage on the rotary tiller or on the tractor if the following operation is effectuated without disconnecting the cardan shaft from the tractor pto.

- Climb on the tractor again, start the motor, lift the machine by about 200 mm from the ground and operate the hydraulic gear case to activate the 2 cylinders which allow the closure of the rotary tiller.
- After the cylinders will have entirely carried out their stroke, the machine will be in a configuration similar to that shown on fig.2.
- Put the safety manual bar.

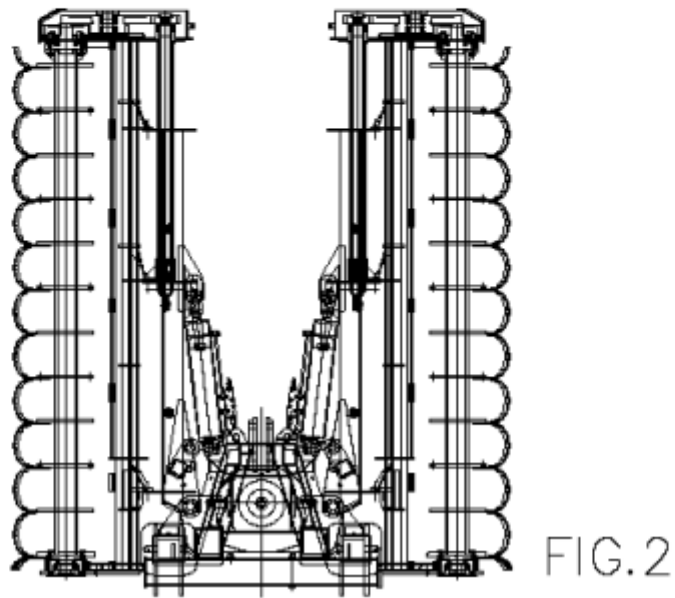
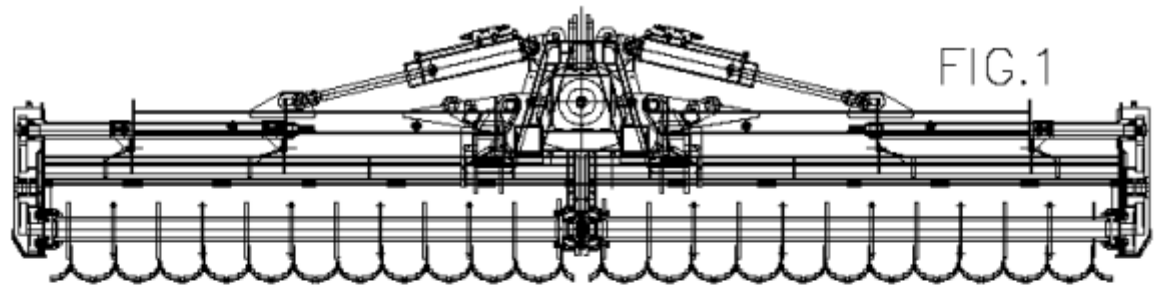

In order to open the Rotary tillers operate as follows:

- Stop the tractor on level ground, activate the handbrake and check that there are no persons, animals or things in a radius of 5 m around the rotary tiller.
- **It is absolutely prohibited** to “open” the rotary tiller from outside the tractor’s driver’s cabin.
- Take the safety manual bar away.
- Operate the hydraulic control lever to lower the 2 mobile parts until, at the end of the cylinders’ stroke, the machine will take up the working condition, namely, perfectly horizontal.
- Ease the Rotary tillers on the ground by operating the tractor’s 3rd point.
- Climb off the tractor and connect the Cardan shaft according to the specific instructions

2.1. TECHNICAL DATA

<i>Model</i>	Weight kg	Tractor Hp
A 900	160	15-30
A 1100	170	15-30
A 1250	180	15-30
A 1450	190	15-30
A 1650	200	15-30
BS 900	195	20-50
BS 1100	224	20-50
BS 1250	234	20-50
BS 1450	246	20-50
BS 1550	266	20-50
BS 1650	276	20-50
BS Super 1250	245	20-55
BS Super 1450	255	20-55
BS Super 1550	275	20-55
BS Super 1650	290	20-55
BS Super 1800	300	20-55
Cultiline 1300	674	60-80
Cultiline 1600	720	60-80
CS 1300	380	40-70
CS 1500	400	40-70
CS 1600	420	40-70
CS 1800	450	40-70
CS 2100	490	40-70
C1 1300	375	40-70
C1 1500	395	40-70
C1 1600	415	40-70
C1 1800	445	40-70
C1 2100	485	40-70
D 1600	540	60-100
D 1800	590	60-100
D 2100	640	60-100
D 2300	700	60-100
D 2500	740	60-100
Strip-Till 3000 (4 Rows)	2650	130-220
Strip-Till 3000 (6 Rows)	2750	130-220
Complete with: Packer roller + Huckepack + Front Tines		

<i>Model</i>	Weight kg	Tractor Hp
HD 1600	560	60-100
HD 1800	615	60-100
HD 2100	660	60-100
HD 2300	710	60-100
HD 2500	750	60-100
HD 2800	790	60-100
EL 2500	905	60-120
EL 3000	1025	60-120
FL 2500	1100	80-140
FL 3000	1200	80-140
GL 2500	1520	130-220
GL 3000	1480	130-220
GL 3500	1685	130-220
GSL 4000	1940	150-240
GSL 4500	2120	150-240
Kappa 4000	2690	190-300
Kappa 4500	3090	190-300
Kappa 5000	3490	190-300
Kappa 6000	3920	190-300
Gamma 5000/P	4090	180-380
Gamma 6000/P	4490	180-380
Reverse 1500	850	80-120
Reverse 1700	940	80-120
Reverse 1850	1010	80-120
Reverse 2000	1070	80-120
Reverse 2300	1180	80-120
Reverse 2500	1320	80-120
Reverse 3000	2496	180-300
Reverse 4000	3140	180-300
RU 3100	1880	160-300
RU 3600	2060	160-300
RU 4100	2240	160-300
RU 4100 DT	2430	160-300
RU 4600 DT	2610	160-300
RU 4850 DT	2700	160-300
RU 6300 DT	/	160-300

2.2. STABILITY OF THE COMBINED MACHINE/TRACTOR UNIT

To avoid rollover accidents, the tractor to be coupled to the rotary tiller must be chosen taking into account the weight of the equipment (kg). Moreover, the tractor power must be suitable for the rotary tiller dimensions. FALC recommends the following tractor power values:

$$M \times s \leq 0,2 T \times i + Z (d + i)$$

$$M \leq 0,3 T$$

i = distance between tractor wheels	T = tractor weight
d = distance of the front axis from the ballast	Z = ballast weight
s = start from the rear axis of the shredder	M = weight

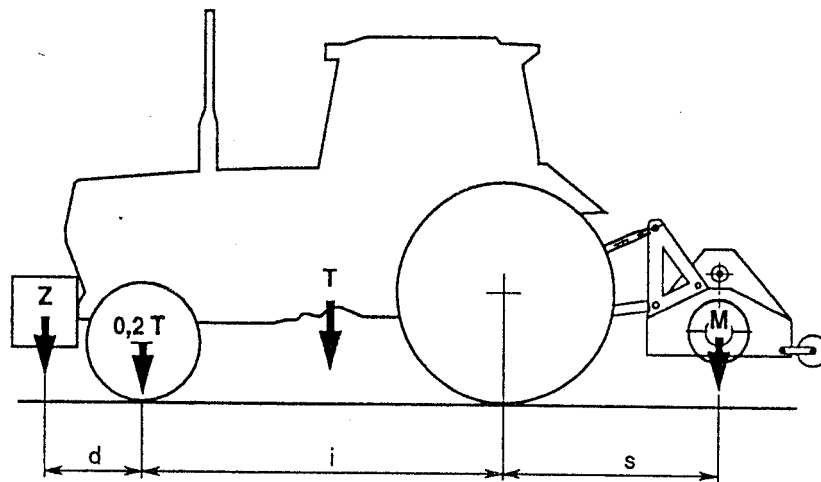

IT IS PROHIBITED TO TAKE ON BOARD AND TRANSPORT PERSONS, ANIMALS OR OBJECTS ON ALL ROTARY TILLERS PRODUCED BY FALC.

3. CONDITIONS FOR THE OPERATOR

- 1) Before commissioning the machine, make sure that the safety guards provided have been installed properly.
If the guards are damaged, do not use the machine until they have been replaced with original spare parts.
- 2) During use of the rotary tiller, the operator must stay on the tractor in the driver's position. The operator cannot leave the driver's position on the tractor if he hasn't disengaged the power take-off from the tractor itself and has not waited for the moving parts of the rotary tiller (rotor, etc.) to come to a complete standstill.
- 3) In normal conditions, that is, with the rear bonnet closed, the operator must ensure that when starting up the rotary tiller and during its operation, there are no persons within a radius of 5 m around the machine. **The operator must immediately stop the tractor as well as the rotary tiller if one or more persons enter within a 5 m radius around the machine.**
- 4) The operator cannot activate the tractor's lifting device without first disconnecting the power take off. **Before lifting the rotary tiller from the ground using the tractor's lifting device, the operator must ensure that the power take off is disconnected.**







5) Sound level

Determining sound power levels under no-load conditions (UNI EN ISO 4254-1)

Sound pressure level: LpAm (A)	db 81.1
Sound power level: LwA (A)	db 97.8

6) During the various service life stages of the machine, the operator is obliged to wear personal protective equipment.

The PPE to be used for each single stage is listed in the following table.

STAGE	 Protective clothing	 Safety shoes	 Gloves	 Goggles	 Ear protectors	 Face mask	 Helmet
Handling	YES	YES	YES	NO	NO	NO	YES
Installation	YES	YES	YES	NO	NO	NO	NO
Ordinary use	YES	YES	YES	NO	YES	YES	NO
Cleaning	YES	YES	YES	YES	NO	YES	NO
Maintenance	YES	YES	YES	YES	NO	NO	YES
Demolition	YES	YES	YES	NO	NO	NO	NO

PPE must be CE marked and comply with Regulation (EU) 2016/425.

3.1. CONNECTION OF THE ROTARY TILLER TO THE TRACTOR

- 1) All Falc rotary tillers can be applied to any type of tractor as long as it is supplied with 3-pin universal attachment.
- 2) The rotary tiller must be positioned on the level and in a stable position.
- 3) The tractor must reverse towards the rotary tiller until its arms correspond with the arms of the 3p rotary tiller. During this phase, any pedestrian operator must be at least 5 m. from the machine.
- 4) Position the plugs of the lower 3 pins and block them using the supplied cotter pins.
- 5) Connect the upper tractor arm to the upper pin of the 3-pin, adjusting it in a way that the machine takes on a horizontal position with respect to the ground.
- 6) Position the cardan shaft and, as specified by standard EN ISO 4254-1:2013, make sure that the guard overlaps that of the PTO shaft by 50mm, with the shaft in a straight position.

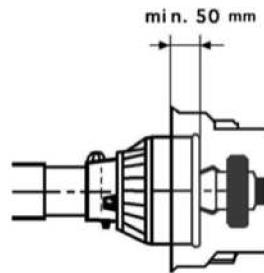

- 7) Fix the anti-rotation chains present on the drive shaft both on the tractor side and on the rotary tiller side. **During this phase the tractor engine must be switched off, to prevent an incorrect manoeuvre from activating the Power take off (PTO).**

NOTE: For any other information regarding the installation of the PTO shaft, please refer to the relevant instruction manual for use.

- 8) After having carried out these operations, it is possible to activate the tractor lifting device to release the support feet (if present), which must be completely raised and blocked using the supplied pins.
- 9) NORMAL SUPPLY:
Power take off (PTO) of the tractor = 540 revs/minute
for models A-BS/BS Super-C1/CS-D/HD- Cultiline-Reverse 15-17-185-20-23-25
Power take off (PTO) of the tractor = 540/1000 revs/minute
for models EL (check the couple of gears mounted in the gearbox)
Power take off (PTO) of the tractor = 1000 revs/minute
for models FL-GL-GSL-Kappa-Gamma/P- RU- Reverse 3000-4000-Strip-Till
- 10) If the land has masses, stones or anything else that may cause a blow to the hoes, the use of propeller shafts with clutch or with other safety systems (shear Bolt Torque Limiter or Automatic Torque Limiter LR) is indispensable. It is also advised to let the motor tick over at low revs, in a way to soften blows to a maximum. Any problems caused by working on particularly rocky land will not be covered by the warranty. The calibration of the cardan joint clutch must also be checked to be sure that it carries out its function correctly. It is advised to carry out this control at a specialised centre. The clutches on the propeller shaft normally supplied by Falc, are calibrated to the maximum available load. It is advised to have the propeller shaft clutch controlled by a specialist every 300 working hours or, if the work is seasonal, on re-starting activity after the break.

3.2. INSTALLATION OF THE PTO SHAFT

IF THE GUARD OF THE PTO SHAFT IS DAMAGED, MANDATORY REPLACEMENT IS REQUIRED.

- 1) Before installing the PTO shaft, it is necessary to temporarily remove the PTO guard from the box.

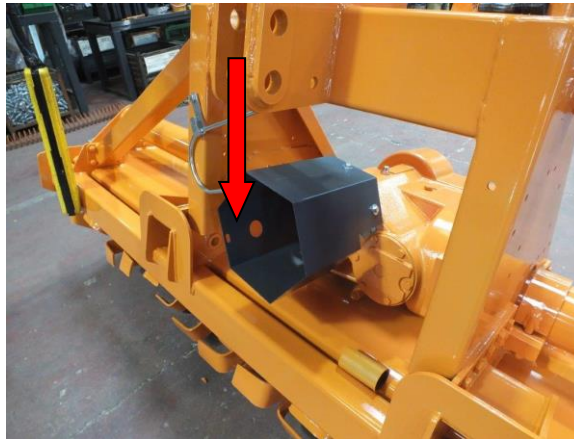

- 2) To remove the guard you need to unscrew the 3 bolts with a spanner, so as to expose the PTO.



- 3) Once the PTO is exposed, the PTO shaft can be mounted.



4) After mounting the shaft, tighten the bolt.



5) Put the PTO guard back into place on the rotary tiller side.



6) Insert the relevant hook.



7) Remove the hook before coupling the PTO shaft.

3.3. DISCONNECTION OF THE ROTARY TILLER FROM THE TRACTOR

The arrangements necessary for correct disconnection of the rotary tiller from the tractor are the following:

- 1) Stop the tractor on level ground, activate the handbrake and remove the power take off.
- 2) Rest the rotary tiller on the ground in a way that it is stable and horizontal.
- 3) Switch the tractor engine off.



- 4) Disconnect the cardan joint from the tractor's power take off and place it on the relevant hook.
- 5) Disconnect the rotary tiller from the 3-point hitch of the tractor first by sliding out the split pins that block the dowels and then by removing the pins themselves.
- 6) Climb onto the tractor again and move it forward to completely free the tractor's arms from the 3rd point of the rotary tiller.

3.4. ROTARY TILLERS CS-D-HD-EL-FL-GL-GSL-CULTILINE-STRIP-TILL: GEARBOX WITH MANUAL REPLACEMENT OF THE GEARS

The CS-D-HD-EL-FL-GL-GSL-Cultiline-Strip-Till series have a gearbox with manual gears replacement mounted on them. It is therefore possible to vary the gear ratio depending on the operator's specific requirements.

MANUAL REPLACEMENT OF THE GEARS IN THE GEARBOX CAN ONLY BE CARRIED OUT IF THE ROTARY TILLER IS NOT CONNECTED TO THE TRACTOR'S POWER TAKE OFF.

The operations for gears replacement are the following:

- 1) Stop the tractor with the rotary tiller attached on level ground, activate the handbrake and disconnect the power take off.
- 2) Get off of the tractor and disconnect the cardan joint from the tractor's power take off.
- 3) Wait for the gearbox to cool before touching it. Cooling time depends on previous use of the rotary tiller before stopping and also atmospheric conditions.
- 4) After having ensured that the gearbox is cold, unscrew the outlet plug and collect the air that runs out in an adequate container.
- 5) ATTENTION: do not dispose of this oil in the environment.
- 6) Remove the rear cover and pay attention not to damage the seal (if present).

- 7) Replace the mounted gears with those stocked scrupulously following the diagram shown on the label supplied with every rotary tiller (if in doubt about the positioning of the gears, refer to the area's authorised dealer or Falc sales office directly).
- 8) Rotary tillers CS-D-HD-Cultiline: position the replaced gears in the relevant seats in the cover and block them carefully.
- 9) Remount the cover, the relative seal (if present), place the screws and position the outlet plug.
- 10) Use the inlet plug to replace the oil previously removed and check the level.

3.5. ROTARY TILLERS Kappa: GEARBOX WITH LEVER CHANGE

The rotary tillers of the Kappa series have a gearbox with 3-speed gearstick.

To change the rotation speed of the rotor follows the indications below:

- 1) Stop the tractor on level ground with the rotary tiller attached, activate the handbrake and disconnect the power take off.
- 2) Get down from the tractor and remove the cardan joint from the tractor's power take off.
- 3) Wait for the gearbox to cool down before touching it. The cooling time depends on the previous use of the rotary tiller and atmospheric conditions.
- 4) Activate the gearstick to insert the desired gear ratio.

The possible speeds that can be obtained with the gearstick are stated on the label applied to every rotary tiller. If in doubt about the speed inserted, refer to the area's authorised dealer or Falc sales office directly.

3.6. ADJUSTMENT OF WORKING DEPTHS

Before using the rotary tiller it is necessary to supervise working depth adjustment in a particular manner.

Adjustments can only be made when the machine is stopped and the Cardan joint is not connected to the tractor's power take-off.

RECOMMENDED WORKING DEPTH: 110 mm OR GREATER.

Each rotary tiller model has its own depth adjustment system.

Rotary tillers D-HD-EL-FL-GL-GSL-Kappa-Gamma/P-Reverse-RU with roller or wheels:

The working depth is adjusted by positioning the 2 dowels in the holes of the machine's fixed side panels, in such a way as to block the movement of the rear roller or of the wheels (pos.A). The arms can be completely blocked by using the second dowel furnished (pos.B).

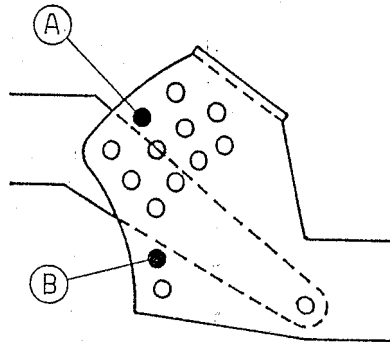

Rotary tillers Cultiline with rear roller:

The working depth is adjusted by means of a hand wheel fixed to the upper part of the rotary tiller and to the roller's frame

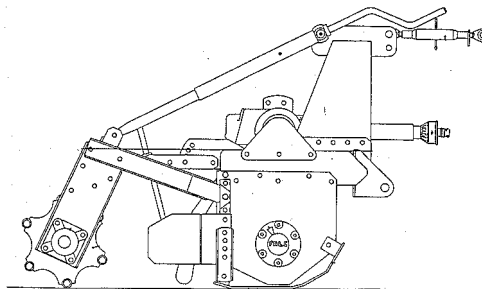

Rotary tillers A-BS/BS Super-C1/CS-D-HD-EL-FL-GL-GSL-Kappa with skids:

The working depth is adjusted by moving the skids by one or more positions with respect to the side to which they are bolted. It is recommended to position the skids always at the same height so as not to have a different working depth between one side of the rotary tiller and the other.

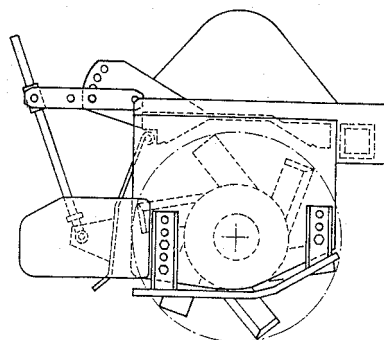

3.7. REAR GUARD ADJUSTMENT

Together with working depth adjustment it is opportune also to adjust the rear guard bonnet.

Rotary tillers A-BS/BS Super: it is possible to adjust the height of the rear bonnet by lengthening or shortening the carrying chain.



CARRYING CHAIN

Rotary tillers C1/CS-D-HD-EL-FL-GL-GSL-Kappa-Gamma/P-RU: it is possible to adjust the height of the rear sump by moving the arm with shock absorber spring by one or more positions.



ARMS WITH SHOCK ABSORBERS

The position of the rear bonnet determines the good result of working:

- 1) Dry lands: to obtain the best breaking-up of the land and perfect levelling, the bonnet must be lowered and kept near to the hoes.
- 2) Damp, wet or clayey land: to prevent flooding the bonnet must be raised and kept as far away as possible from the hoes

The adjustments can only be carried out when the machine is at a standstill and the cardan joint is not connected to the tractor's power take off.

3.8. ROTARY TILLERS EL-FL-GL-GSL-Kappa-Strip-Till: USE OF THE SOWER HITCH

The EL-FL-GL-GSL-Kappa-Strip-Till series rotary tillers are predisposed to utilize a hydraulic sower hitch.

The various types of sower hitches manufactured by FALC can only be utilized if linked to machines manufactured by FALC. Even if sold separately as accessories, they absolutely cannot be linked to other types of machines. Improper use of a sower hitch produced by FALC, will be considered illegal and not permitted by the manufacturer.

The sower hitch can be supplied already mounted on the machine or as an accessory to be applied by the end user. It is anyhow recommended to always consult a service center, or directly FALC's commercial or technical departments if one intends mounting a sower hitch on an existing rotary tiller.

The sower hitch is fixed to the rotary tiller's 3rd point in 3 positions (A) by means of dowels and relative split pins..

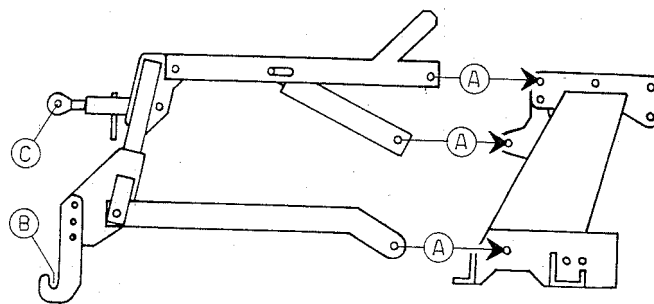

To mount the sower hitch, follow these operations:

- 1) Stop the tractor and the rotary tiller on plane ground, activate the handbrake, switch the tractor off and ease the rotary tiller on the ground taking care that it maintains a plane configuration with respect to the ground.
- 2) Disengage the tractor's power take-off.
- 3) Climb off the tractor, disconnect the Cardan shaft from the tractor's power take-off and place it in the relative support.
- 4) Lift the sower hitch with suitable lifting apparatus and place it in correspondence of the hitches located on the rotary tiller's 3rd point.

ATTENTION: if suitable apparatus is not available to carry out this operation, it is recommended to always consult a FALC service center or a specialized workshop.

- 5) Position the dowels and block them with the split pins.

In transport conditions, namely, with the hydraulic sower hitch positioned, it is compulsory to fix the safety dowel (A) in correspondence of the holes provided on the upper part of the rotary tiller's 3rd point.

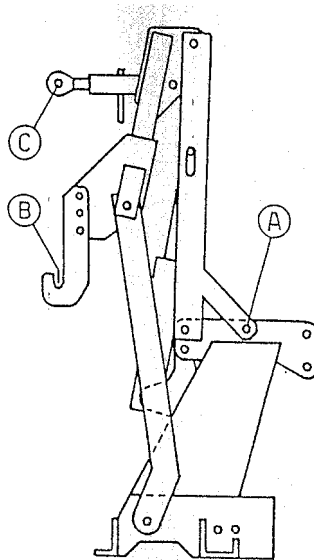

The sowing machine must be placed in location of the 2 hooks (**B**) and of the adjustable tierod (**C**).

If the sowing machine is to be connected to the rotary tiller's gearbox by means of the Cardan joint, the plastic output shaft cover on the rear side of the gearbox itself must be removed and replaced with an appropriate cover which is supplied on request.

THE COVER OF THE ROTARY TILLER'S GEARBOX'S THROUGH SHAFT CAN ONLY BE REMOVED IF A CARDAN SHAFT CONNECTION WITH A SOWING MACHINE IS TO BE CARRIED OUT.

As soon as the junction between the rotary tiller's gearbox and the sowing machine is disconnected, it is obligatory to reposition the cover of the through shaft.

As already highlighted, the installation of the sower hitch, the sowing machine and the connection between rotary tiller and sowing machine by means of a cardan shaft can only be carried out if the tractor and the rotary tiller are NOT connected by cardan joint.

Connection of the hydraulic seeder attachment:

Rotary tillers EL-FL-GL: Hydraulic Seeder Attachment with 1 piston

Rotary tillers GL-GSL-KAPPA-Strip-Till: Hydraulic Seeder Attachment with 2 pistons (with adjustable arms)

The seeder attachment is complete with hydraulic pipes with automatic coupling for connection with the control unit on the tractor. By activating the hydraulic control unit lever, movement of the seeder attachment and seeder is obtained.

During the movement phases of the sower hitch and of the sowing machine, the operator must ensure that there are no persons, animals or things within a radius of 5 m around the machine.

If the operator uses the Hydraulic Seeder Attachment for the first time, he is advised to practice movements made possible by the pistons before starting work.

3.9. ROTARY TILLERS D-HD-EL-FL-GL-GSL-Kappa: USE WITH ADJUSTABLE TRACE BREAKER.

One or more adjustable trace breaker can be applied to the front pipe of the rotary tiller's framework by means of threaded clips. Normally, the ploughing peg teeth are positioned in couples close to the tractor wheels.

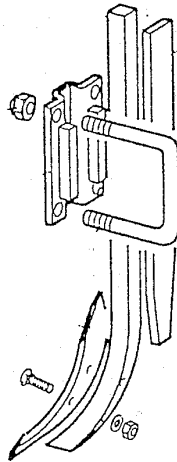

3.10. ROTARY TILLERS EL-FL-GL-GSL-Kappa: USE WITH SUBSOILER

In order to reduce production costs, it is possible to apply a subsoiler in front of the rotary tillers to “break” the ground in depth. The subsoiler is provided with suitable hitches for application to the rotary tiller and to the tractor's rear arms

It is necessary to dispose of suitable lifting means to apply the subsoiler to the rotary tiller. If suitable lifting apparatus is not available to apply the subsoiler to the rotary tiller's 3rd point, it is compulsory to consult a FALC service center or a specialized workshop.

The weights of the subsoilers are the following:

Subsoiler 3000 = kg 490

Subsoiler 4000 = kg 670

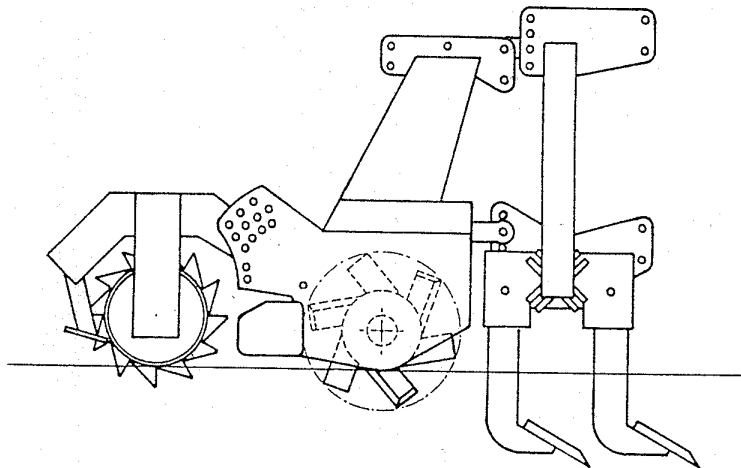

4. OPERATION

Start with PTO at operating speed and gradually lower the machine into the ground. During this operation all **personnel involved must stay at a distance of at least 5 m from the machine.**

The tractor driver must take the following factors into account in order to ensure adequate tillage:

- nature of the soil;
- working depth;
- travel speed;
- optimal machine adjustment.

After adjusting the rear cover according to the required tillage, engage the PTO and start moving with the tractor while slowly lowering the machine.

The machine is equipped with special guards that prevent access to its moving parts.

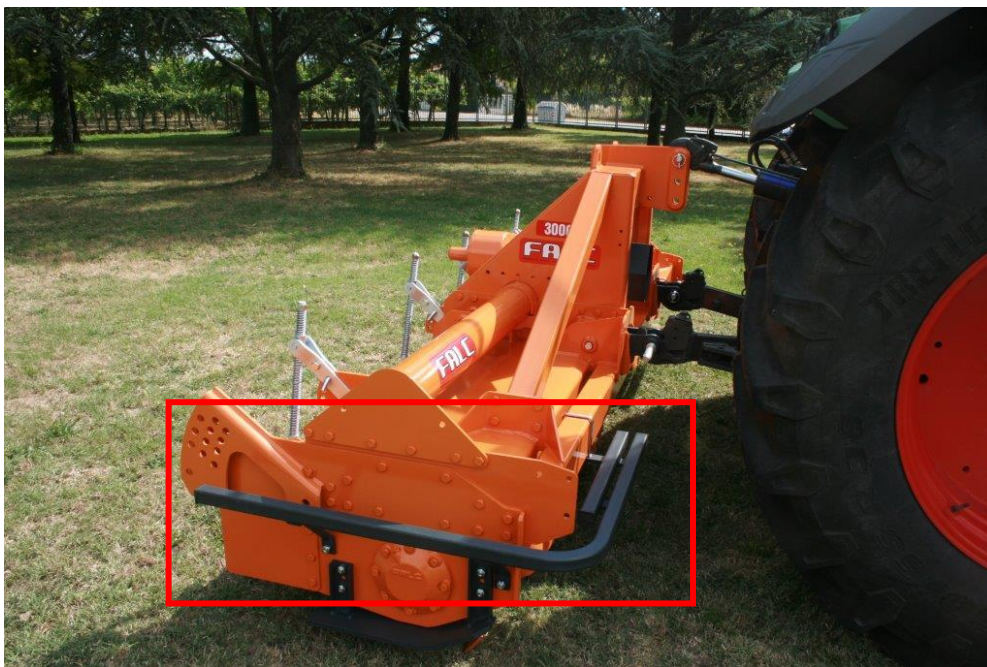

WARNING:

It is forbidden to use the machine without guards.

It is forbidden to go between the tractor and the machine if the engine is on and the PTO shaft is engaged or if the hand brake is not engaged.

Do not operate the machine when it is above the ground.

It is forbidden to turn when the machine is in the ground.

It is forbidden to work in reverse gear.

Before adjusting the machine, always turn the tractor off and disconnect the PTO shaft.

5. TRANSPORT

During operation the rotary tillers rest nearly on the roller, on the lateral slides and, in some cases, also on wheels. They are lifted by the tractor arms at the front.

When turning or moving in reverse gear, always lift the machine, as it is forbidden to perform these operations when the machine is working.

To switch from working mode to **transport mode**, it is necessary to **disengage the tractor PTO** and lift the rotary tiller with the tractor's hydraulic lifter.

Then proceed as explained in section 4.

During transport, rotary tillers are supported completely by the tractor (see Point 2.2).

For movement, made necessary for loading, unloading and storage, always use equipment that is suitable for the weight of the machine and use the pegs that are positioned on the machine.

During transport, use the relevant chains and straps to secure the side lifting arms of the tractor.

During road transportation with the machine lifted, set the control lever of the tractor's hydraulic lifter to the lock position. If while the machine is lifted from the ground the PTO shaft couplings are bent at an angle over 40° (PTO stopped), remove the PTO shaft from the tractor.

As a result of the space taken up during transport, it may be necessary to dismantle the side and front guarding furnished. In this case, the guarding will be placed in a very evident manner on the machines onto which they will have to be remounted; it will be the responsibility of the receiver to provide for their positioning. In order to correctly position the side and front guarding simply consult the spare parts table related to the specific type of rotary tiller. The guards are supplied complete of their fixing nuts and screws. If in doubt, contact the area service centre or directly FALC's sales or technical departments.

6. MAINTENANCE AND REPAIRS

Before approaching the machine to carry out any maintenance or repairs, it is compulsory to take some precautions:

- 1) Stop the tractor on level ground**
- 2) Ease the rotary tiller on the ground**
- 3) Activate the handbrake**
- 4) Disengage the power take-off**
- 5) Turn the engine off.**

In case of specific maintenance or repair where it is necessary to lift the machine from the ground or rotate it, it is indispensable to use suitable equipment built for such purposes. It is always recommended to consult the area sales assistance or mechanical workshops ideally equipped. The machines' weights are reported in point 2.1. of this manual.

Wait for very hot machine parts, such as the gearbox, bearings, chains, etc. to cool, before carrying out any interventions. The cooling time for these parts depends on the previous work carried out and external atmospheric conditions.

6.1 Maintenance

Lubricants used		
Rotary tiller A – BS/BS Super C1/CS – D	Gearbox	(oil MobilGear 634 - SAE 140) (oil Mobilgear 600 XP 460) oil DIN 51517 part 3 CLP - ISO VG 460
	Lateral transmission	(grease EP1) grease EP lithium - NLGI 1
Rotary tiller HD – EL – FL – GL – GSL – Kappa – Cultiline Reverse – RU – Strip-Till	Gearbox	(oil MobilGear 634 - SAE 140) (oil Mobilgear 600 XP 460) oil DIN 51517 part 3 CLP - ISO VG 460
	Lateral transmission	(oil MobilGear 634 - SAE 140) (oil Mobilgear 600 XP 460) oil DIN 51517 part 3 CLP - ISO VG 460
Rotary tiller Gamma/P	Gearbox	oil (MobilGear 634 - SAE 140) (oil Mobilgear 600 XP 460) oil DIN 51517 part 3 CLP - ISO VG 460
	Lateral transmission	(oil Mobilgear 600 XP 1000) oil DIN 51517 part 3 CLP - ISO VG 1000 Totally Synthetic

Even though all the rotary tillers are delivered well greased and lubricated, hereafter is a list of rules which must strictly be adhered to, so as to obtain the best results.

- 1) After the first hour of operation**
 - Check that all bolts and screws are correctly tightened.
- 2) Daily**
 - Check the oil level in the transmission box
 - Check the oil level of the lateral transmission (both with chains and gears).

- Check the guard of the PTO shaft. **In the event of damage, the PTO shaft guard must be replaced.**
 - Lubricate the cardan joint (see the specific instruction book relative to the drive shaft).
ATTENTION: the Cardan joint is in general supplied by FALC and is suitable for the effective power required for the tractor-shredder link-up. In case of replacement always use a Cardan joint with characteristics not inferior to those of the original Cardan shaft.
- 3) **Every 8 working hours (use EP2-NLGI2 lithium grease)**
- Lubricate rotor bearings using the relevant greasers that are indicated on the machine. Grease moderately introducing a small amount of grease at a time.
 - Grease all points indicated on the machine.
- 4) **Every 8 working hours – For rotary tillers with secondary chain drive**
- Check chain tension to prevent rapid wear of the chain and relative gears.
- 5) **Every 300 working hours**
- Change the oil in the transmission box and in the side transmission.
 - Check that the gearbox vent cap is not blocked internally with dust or earth.
- If in doubt replace the vent cap.
ATTENTION: the used oil must not be discharged into the natural environment, but consigned to bodies authorized for collection and subsequent disposal.

6.2 Rotary tillers A-BS/BS SUPER-Cultiline- REVERSE- RU: checking the tension of the side transmission chain

The chain tension can only be checked if the rotary tiller is **not** connected to the tractor's Power Take-Off with the Cardan joint.

It is hence prohibited to approach the side transmission if the machine is connected to the tractor's Power Take-Off with the Cardan joint.

To check for the correct tension of the chain, the operations are as follows:

- 1) Loosen the counternut (B).
- 2) Screw with in the adjustment screw (A) with a screwdriver or special spanner.

ATTENTION: If the chain is too loose or too tight, it can cause breakages on various mechanical components of the rotary tiller.

If in doubt or difficulty in adjusting the chain, contact the area service center or directly FALC's sales or technical departments.

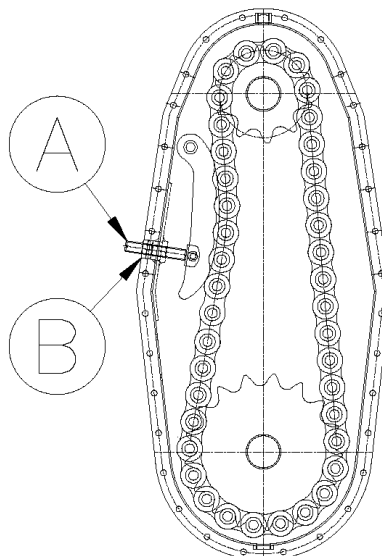

7. CAUSES OF POSSIBLE MALFUNCTIONS AND RELEVANT ACTIONS

Excessive soil tillage

CAUSE:

ACTION:

Rear casing too closed

Lift the rear casing to reduce clod crushing.

Travel speed too low

Increase travel speed.

Rotor rotation overspeed (versions with gearshift)

Reduce rotor rotation speed (version with gearshift).

Poor soil tillage

CAUSE:

ACTION:

Rear casing too open.

Lower the rear casing to increase clod crushing.

Travel speed too high

Reduce travel speed

Soil too wet

Do not work on excessively wet soil.

Low rotor rotation speed (versions with gearshift)

Increase rotor rotation speed (version with gearshift).

Rotor clogging

CAUSE:

ACTION:

Soil too wet

Do not work on excessively wet soil

Rear casing too closed

Lift the rear casing

Travel speed too high

Reduce travel speed

Presence of very long grass and/or of excessively long residues

Avoid working if the grass is very long or in the event of very long residues; if necessary, thoroughly clean by removing any residues from the supports on the rotor sides to prevent them from overheating.

The machine bounces on the ground or vibrates

CAUSE:

ACTION:

Foreign bodies stuck between the hoes

Remove any foreign bodies from the rotor

Improperly mounted hoes, without helical configuration or with the non-cutting edge penetrating the ground first

Remove the set of hoes and mount it correctly.

Worn or damaged hoes

Replace the entire hoe set.

Rotor deformation due to blows by foreign bodies in the central part during work.

Replace the rotor.

Insufficient work depth

CAUSE:

ACTION:

Incorrect adjustment of the depth skids.

Readjust the depth skids.

Insufficient tractor power

Reduce travel speed.

Soil too hard

Repeat the operation several times.

Insufficient penetration of the hoes into the soil

Reduce travel speed.

8. WARRANTY

- a) Warranty period is fixed at 1 year from delivery. The company commits itself to replace parts which might present material or construction defects, in the least time possible. Labor time necessary for the replacement is excluded from the warranty. Transport and/or dispatch expenses are also excluded from the warranty.
- b) The buyer loses the warranty right if the faults are derived from force majeure, from an incorrect use of the machine or from any wrong action on behalf of the buyer, his employees or third parties. Repairs, replacements and modifications carried out or made to carry out by the buyer without the manufacturing company's authorization are included among these actions. An incorrect use of the machine is the result of absence of adherence to the operating instructions listed in this manual.
- c) Parts which due to their nature or function are subject to inevitable wear and tear or strain, are excluded from the warranty.
- d) Bearings and oil seals are excluded from the warranty.
- e) The Cardan shaft is excluded from the warranty
- f) The following rules are applicable to the parts for which warranty is intended:
 - the part to be replaced must be returned to the company on request of the new part.
 - the spare parts will always be invoiced on dispatch.
 - **only the examination of the part on behalf of the manufacturing company's technicians could give the right to recognition of the warranty and hence a right to the credit.**

9. RULES TO OBSERVE TO ORDER SPARE PARTS CORRECTLY

To obtain a speedy dispatch of spare parts orders, it is necessary to specify:

- a) Machine type, Model, Serial Number.
(e.g. ROTARY TILLER GL 3000 S.N. XXXXX)
- b) Spare parts table number where the part in question is located, Identification Number, Part code.
(e.g. Table no. YY, Detail no. JJ, Code KKKKKK)
- c) Exact name of the detail.
- d) Quantity of pieces requested.
- e) Dispatch instructions.
(by rail, parcel post, courier, etc.)
- f) The minimum delivery time of the requested parts is 3 days from receipt of order

IF ANY PART OF THIS INSTRUCTION MANUAL SHOULD RESULT INSUFFICIENTLY CLEAR, WE ASK YOU TO KINDLY CONTACT YOUR CLOSEST AUTHORISED DEALER OR CONTACT US DIRECTLY AT OUR TECHNICAL AND COMMERCIAL DEPARTMENTS.

This handbook or any part of it cannot be reproduced, copied or published without prior written authorization of FALC. FALC reserves the right to modify the here described specifications at any time without committing itself to update this handbook every time.

10. SAFETY PICTOGRAMS

All the safety pictograms applied to Falc's machines, are based on norms ISO 11/684.

The adhesive labels adopted are 168 x 88 mm and are divided in two equal parts.

The left part contains within the triangular danger symbol the graphic description of the symbol itself.

e.g. Attention - Danger of flying objects.

The right part shows how to avoid the risk.

e.g. Maintain a safety distance.

Together, these 2 graphics synthesise the full message which is intended to be transmitted to all those which for various reasons are in direct contact or nearby a Falc-produced machine.

(see enclosure C of the norm)

The graphical message is hence directed to the machine operators as well as all those that enter within the working radius of the machine.

The operator is obliged to carefully read the machine's instruction manual in order to understand its correct operation and to have a comprehensive explanation of the safety pictograms

The complete list of all the pictograms which are applied to Falc-produced machines is reported hereafter with the relative explanation on the side.

Label no.1

ATTENTION: Read the instruction manual before using the machine.

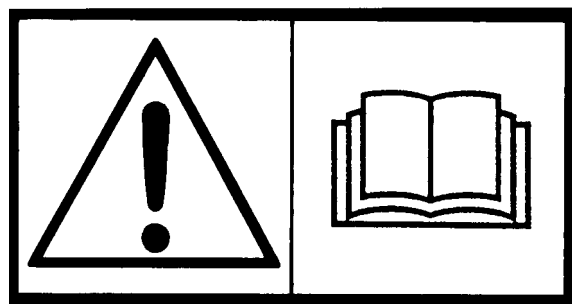

FALC FAENZA (RA) - ITALY - TEL. 0546/29050 - FAX 0546/663986 1

Label no.2

ATTENTION: Danger of hand and fingers collision with movements in alternate rotation. Keep the safety distance.

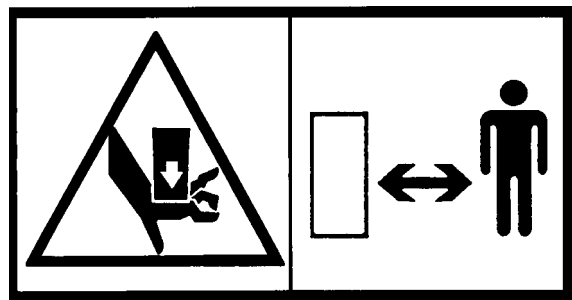

FALC FAENZA (RA) - ITALY - TEL. 0546/29050 - FAX 0546/550866 2

Label no.3

ATTENTION: Danger of foot collision with movements in alternate rotation. Keep the safety distance.

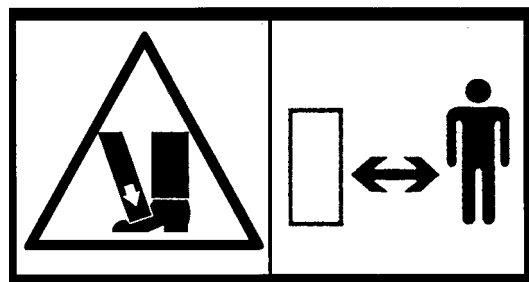

FALC FAENZA (RA) - ITALY - TEL. 0546/29050 - FAX 0546/550866 3

Label no.4

ATTENTION: Danger for feet due to rotating cutters with horizontal rotating axis.
Keep the safety distance.

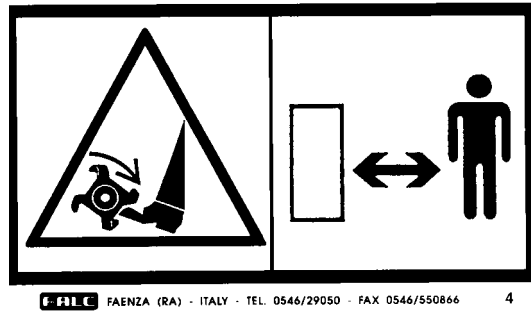

Label no.5

ATTENTION: Danger due to machine component that can be lifted from the ground.
Keep the safety distance.

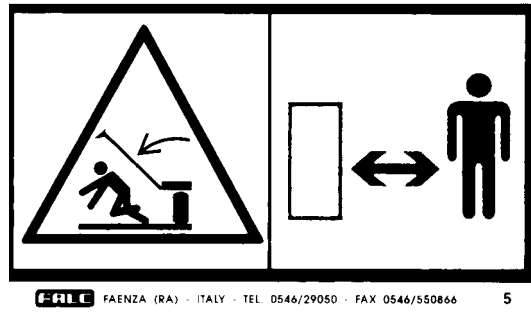

Label no.6

ATTENTION: Danger of cutting due to moving parts.
Wait until all moving components are completely still before approaching the machine.



Label no.7

ATTENTION: Danger due to flying objects.
Keep the safety distance.

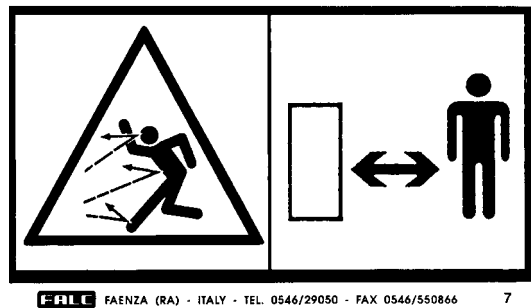

Label no.8

ATTENTION: Danger due to hot surfaces.
Keep the safety distance.



Label no.9

ATTENTION: Danger of hand and finger cutting.
Keep the safety distance.

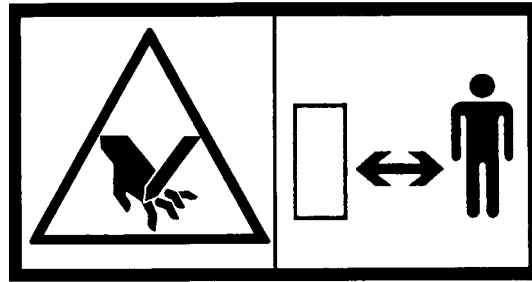

Label no.10

ATTENTION: Danger of feet cutting.
Maintain the safety distance.

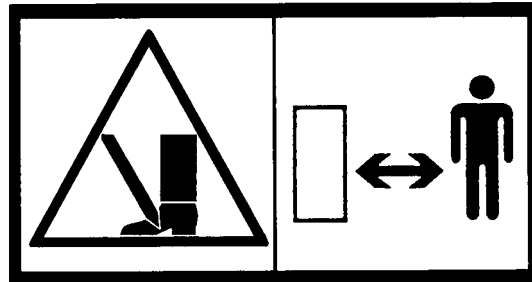

Label no.11

ATTENTION: Danger of rotating movements.
Do not open or remove the safety guards of the rotating shafts while the machine is in operation.

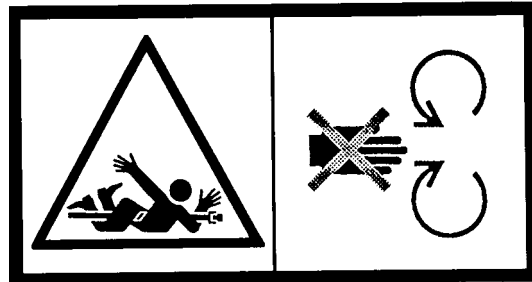

Label no.12

ATTENTION: Danger due to loads lifted from the ground.
Keep the safety distance.

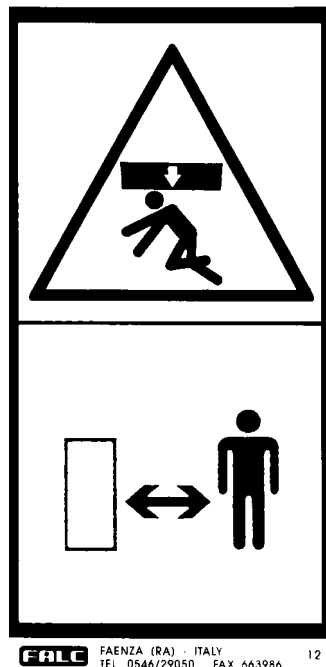

Italiano: Istruzione per il montaggio del cardano

<p>Prima di montare il cardano, leggere attentamente il Libretto fornito dal costruttore del cardano stesso. La Ditta Falc Srl declina ogni responsabilità per operazioni effettuate sul cardano senza seguire le Istruzioni specifiche fornite dal costruttore del cardano stesso.</p>	<p>Prima di iniziare a lavorare, si raccomanda di verificare la lunghezza del cardano: se è LUNGO, alzando o abbassando la macchina, le 2 parti telescopiche si accoppieranno completamente creando pressione sulle crociere e sulle forcelle; se è CORTO, alzando o abbassando la macchina, le 2 parti telescopiche si sfileranno troppo.</p>	<p>Le macchine agricole portate sono collegate direttamente al trattore e posizionate mediante attacco a tre punti. Generalmente con attrezzo in lavoro (a) si ha la configurazione di minore lunghezza dell'albero ed angoli di snodo sensibilmente uguali. Ad attrezzo sollevato (b) si ha la massima estensione dell'albero, l'aumento e la diversificazione degli angoli di snodo. Durante il sollevamento è INDISPENSABILE interrompere la rotazione del cardano.</p>
---	--	---

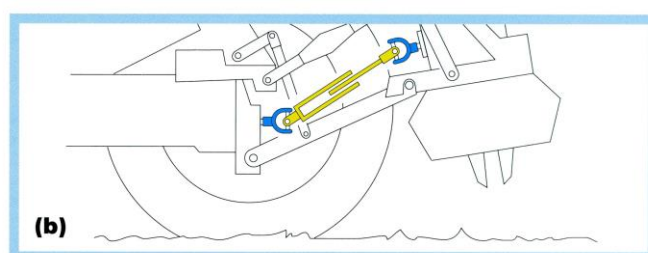
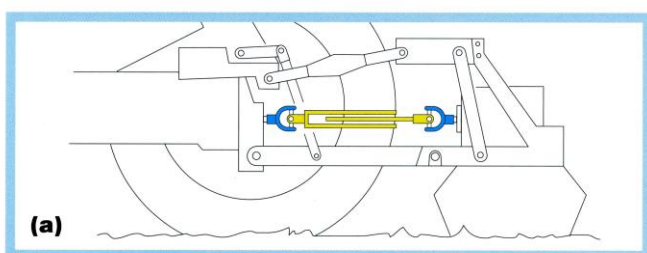

Français: Instructions pour le montage de l'arbre à cardan

<p>Avant de monter le cardan, lire attentivement le Livret fourni par le fabricant du cardan lui-même. L'entreprise Falc Srl décline toute responsabilité pour toute opération effectuée sur le cardan sans avoir suivi les instructions spécifiques fournies par le fabricant de ce cardan.</p>	<p>Avant de commencer à travailler, nous recommandons de vérifier la longueur du cardan : s'il est LONG, en relevant ou en baissant la machine, les deux parties télescopiques vont s'accoupler complètement en exerçant une pression sur les tourillons et les fourchettes ; s'il est COURT, en relevant ou en baissant la machine, les 2 parties télescopiques risquent de se désenfiler trop.</p>	<p>Les machines agricoles portées sont connectées directement au tracteur et mises en place par l'attelage à trois points.. Avec l'outil en fonction (a) la configuration du cardan est de longueur minimum et les angles d'articulation sont similaires. Lorsque l'outil est soulevé (b), l'extension du cardan est au maximum et on a l'augmentation et la diversification des angles d'articulation. Pendant le soulèvement il est INDISPENSABLE d'interrompre la rotation du cardan.</p>
--	--	---

English: Instructions for the assembling of the cardan shaft

<p>Before mounting the cardan shaft, carefully read the booklet supplied by the Manufacturer. Falc Srl declines all responsibility for operations carried out on the cardan shaft if the specific instructions supplied by the Manufacturer are not followed.</p>	<p>Before starting work, it is advised to check the length of the cardan shaft: if it is LONG, by raising or lowering the machine, the 2 telescopic parts will couple completely, creating pressure on the cross and on the forks; if it is SHORT, by raising or lowering the machine, the 2 telescopic parts will slide apart too much.</p>	<p>The agricultural machinery carried is connected directly to the tractor and positioned using a three-point attachment. Generally, when the equipment is functioning (a) the shorter length of the shaft with equal articulation angles is present. With the equipment raised (b) there is maximum extension of the shaft, increase and diversification of the articulation angles. During lifting it is INDISPENSABLE to interrupt rotation of the cardan shaft.</p>
---	--	--

Deutsch: Bedingungen für die Gelenkwellenanbau

<p>Bevor Sie die Kardanwelle montieren, ist das vom Hersteller der Kardanwelle gelieferte Handbuch aufmerksam durchzulesen. Falc Srl haftet nicht für an der Kardanwelle durchgeführte Arbeiten, bei denen die spezifischen Anweisungen des Herstellers der Kardanwelle nicht eingehalten wurden.</p>	<p>Vor dem Beginn der Arbeiten ist die Länge der Kardanwelle zu überprüfen. Falls die Kardanwelle LANG ist, kuppeln die beiden Teleskopteile bei Heben oder Senken vollständig ein und drücken auf das Gelenkkreuz und das Gabelgelenk. Falls die Kardanwelle KURZ ist, fahren die beiden Teleskopteile bei Heben oder Senken zu sehr aus.</p>	<p>Die Anbau-Landmaschinen werden direkt an den Traktor angeschlossen und mit einem Dreipunktanschluss positioniert. Im Allgemeinen sind im Fahrzustand der Maschine (a) die Welle kürzer und die Gelenkwinkel annähernd gleich. Bei gehobener Maschine (b) ist die Welle maximal ausgefahren; die Gelenkwinkel sind größer und unterscheiden sich voneinander. Während des Hubs MUSS die Rotation der Welle unterbrochen werden.</p>
---	--	---

Español: Instrucciones para el montaje de la cardan

<p>Antes de montar el cardan, leer detenidamente el Manual suministrado por el fabricante de éste. La empresa Falc Srl se exime de cualquier responsabilidad frente a operaciones que puedan efectuarse en el cardan sin cumplimiento de las instrucciones específicas dictadas por el fabricante del mismo.</p>	<p>Antes de iniciar a trabajar, se recomienda comprobar que la longitud del cardan sea la adecuada: Si es demasiado LARGO, al alzar o descender la máquina sus 2 partes telescópicas se acoplarán completamente, creando presión en las crucetas y en las horquillas. Si es demasiado CORTO, al alzar o descender la máquina sus 2 partes telescópicas se desengancharán excesivamente.</p>	<p>Las máquinas agrícolas traídas están directamente unidas al tractor por medio de un enganche de tres puntos. Generalmente, cuando el equipo está en posición de trabajo (a) se obtiene una configuración con una menor longitud del árbol y con ángulos de articulación muy parecidos. Con el equipo en posición alzada (b) se obtiene la extensión máxima del árbol, con un aumento de los ángulos de articulación, que ahora serán distintos entre si. Durante la elevación es INDISPENSABLE interrumpir la rotación del cardan.</p>
--	---	---

Nederlands: Instructies voor montage van de aftakas

<p>Lees de door de fabrikant geleverde handleiding aandachtig door alvorens de aftakas te monteren. Falc Srl wijst elke aansprakelijkheid af als de betreffende specifieke montageaanwijzingen niet worden opgevolgd.</p>	<p>Controleer eerst de lengte van de aftakas alvorens met de montage-werkzaamheden te beginnen. Als de aftakas TE LANG is, schuiven de beide telescopische delen volledig in tijdens het heffen en dalen van het werktuig en wordt druk uitgeoefend op de kruiskoppeling en de vorken; Als de aftakas TE KORT is, schuiven de beide telescopische delen tijdens het heffen en dalen van het werktuig te veel uit elkaar.</p>	<p>Aanbouwmachines worden bevestigd aan de driepuntkoppeling van de tractor. In het algemeen geldt dat als het werktuig in bedrijf is (a) de korter is en de knikhoek gelijk. Met het werktuig in geheven positie (b) is de as maximaal uitgeschoven, en is de knikhoek groter en variabel. Als het werktuig wordt geheven MOET de aftakas worden uitgeschakeld.</p>
---	--	--

Dansk: Montage af kardanaksel

<p>Før montagen af kardanakslens påbegyndes, gennemlæses producentens brugervejledning grundigt. Falc Srl er fritaget for ethvert ansvar i forbindelse med arbejder foretaget på kardanakslens, hvis de givne retningslinier, som er specificeret af producenten, ikke er fulgt nøje.</p>	<p>Før arbejdet påbegyndes, anbefales det at kontrollere kardanakslens længde ved at hæve eller sænke redskabet. Hvis den er for LANG, resulterer det i, at de to kardan dele støder sammen, når redskabet er i sin yderposition, hvilket bevirker et ødelæggende tryk på kardankryds og transmissioner. Hvis den er for KORT, resulterer det i, at de to kardan dele kan glide fra hinanden, hvilket bevirker, at de ikke er i indgreb med hinanden.</p>	<p>Redskabet monteres direkte på traktorens 3-punktsophæng. Generelt gælder, at når redskabet er sænket (a), er kardanakslens i sin korteste position, og når redskabet er hævet (b), er kardanakslens i sin længste position. Når redskabet hæves, SKAL kardanakslens rotation afbrydes.</p>
---	---	---

