

**TRINCIA
BROYEUR
SHREDDER
HÄCKSLER
DESBROZADORA
ИЗМЕЛЬЧИТЕЛЬ**

FALC[®]

WIND



VISION

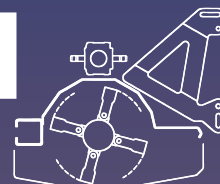

FALC[®]

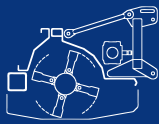

WIND



SOLO POSTERIORE



SEULEMENT ARRIERE



ONLY REAR



NUR HINTER



SOLAMENTE POSTERIOR



ТОЛЬКО ЗАДНИЙ



1

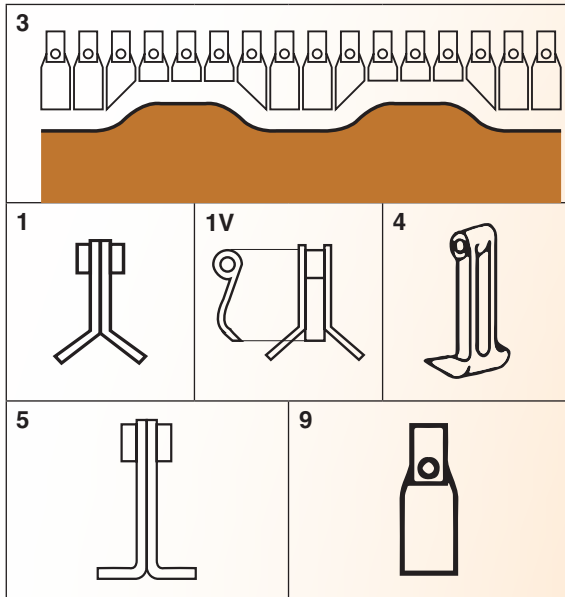

	Velocità periferica dei coltelli
	Vitesse périphérique des couteaux
	Tip speed of blades
	Messersumfangsgeschwindigkeit
	Velocidad periferica de las cuchillas
	Скорость вращения ножей

	G/M del rotore
	T/M du rotor
	Rotor's RPM
	Rotor U/M
	R/M de rotor
	Об/Мин ротора

WIND - VISION	m/sec.	inches/sec.
2700 - 3200	72	2835
3600 - 4000	61	2402

WIND - VISION	
2700	N° 2058
3200	N° 2058
3600	N° 1744
4000	N° 1744



2

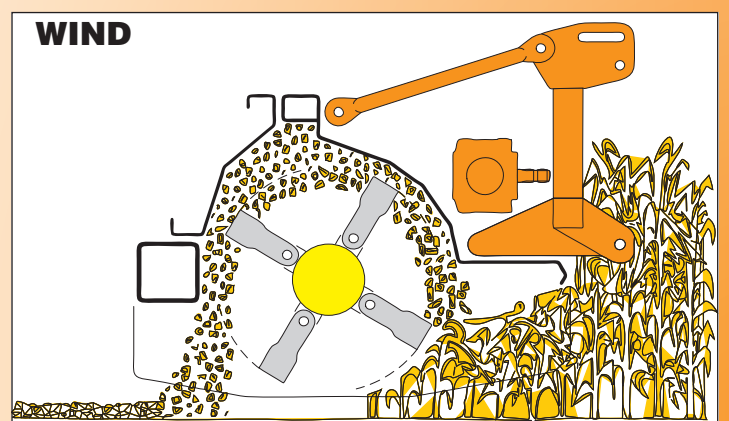

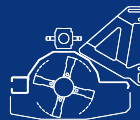

ANTERIORE O POSTERIORE



ANTERIEUR OU ARRIERE



FRONT OR REAR



VORDER ODER HINTER



ANTERIOR O POSTERIOR



ПЕРЕДНИЙ ИЛИ ЗАДНИЙ





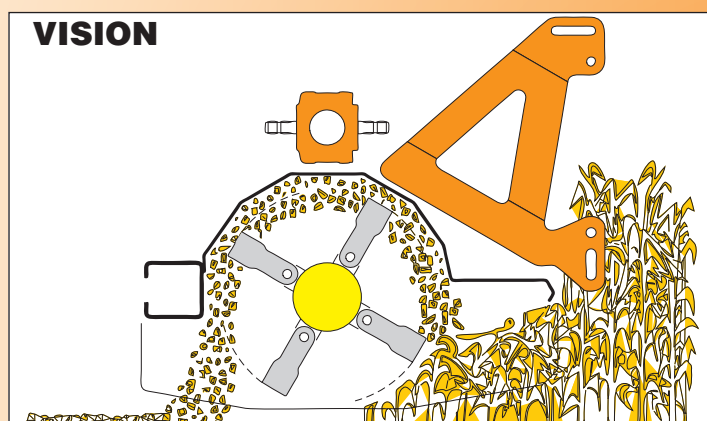

WIND VISION





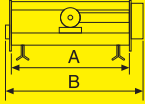
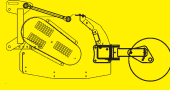
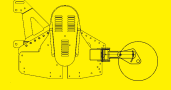

2700-3200-3600-4000	A	Ø mm 663
2700-3200-3600-4000	B	Ø mm 244,5x10
WIND 3200 DT 2700-3200-3600 4000	C	n. 4+4 n. 6



WIND - VISION





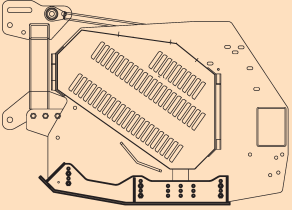

WIND VISION											
	HP	P.T.O.	A mm.	B mm.	A inches	B inches	KG	LBS	KG	LBS	N.
2700	70 - 160	1000	2665	2960	104,92	116,54	1326	2923	1196	2637	56
3200	70 - 160	1000	3184	3479	125,35	136,97	1441	3177	1316	2901	68
3200 DT	70 - 160	1000	3184	3498	125,35	137,72	1681	3706	/	/	68
3600	70 - 160	1000	3655	3950	143,90	155,51	1566	3452	1440	3175	80
4000	70 - 160	1000	4015	4310	158,07	169,69	1671	3684	1545	3406	88

WIND 1

-  Macchina con slitte regolabili
-  Machine avec patins réglables
-  Machine with adjustable skids
-  Maschine mit einstellbarem Kufenpaar
-  Máquina con patines regulables
-  Машина с регулируемыми лыжами







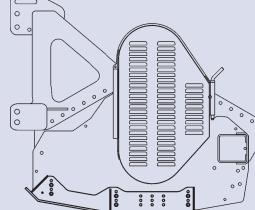

VISION 1

-  Macchina con slitte regolabili
-  Machine avec patins réglables
-  Machine with adjustable skids
-  Maschine mit einstellbarem Kufenpaar
-  Máquina con patines regulables
-  Машина с регулируемыми лыжами



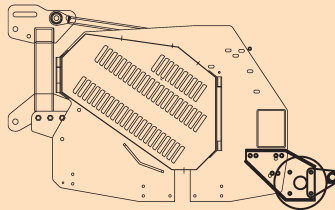

WIND 2

-  Macchina con rullo
-  Machine avec rouleau
-  Machine with roller
-  Maschine mit Walze
-  Máquina con rodillo
-  Машина с валиком









VISION 2

-  Macchina con rullo
-  Machine avec rouleau
-  Machine with roller
-  Maschine mit Walze
-  Máquina con rodillo
-  Машина с валиком





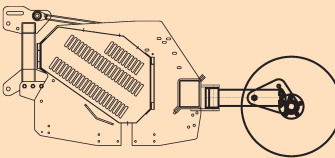

WIND 3

-  Macchina con coppia ruote sterzanti
-  Machine avec couple de roues braquantes
-  Machine with pair of steering wheels
-  Maschine mit Steuerräderpaar
-  Máquina con 2 ruedas girantes
-  Машина с парой рулевых колес



VISION 3

-  Macchina con coppia ruote sterzanti
-  Machine avec couple de roues braquantes
-  Machine with pair of steering wheels
-  Maschine mit Steuerräderpaar
-  Máquina con 2 ruedas girantes
-  Машина с парой рулевых колес

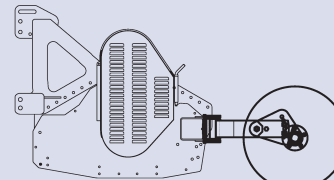

FALC - Via Proventa, 41 - 48018 FAENZA (ITALIA) - e-mail: info@falc.eu - www.falc.eu

Tel. +39 0546 29050
Fax +39 0546 663986



I dati tecnici, le caratteristiche e le illustrazioni sono indicative e non impegnano il costruttore. - Les données techniques, les caractéristiques et les illustrations sont indicatives et n'engagent pas le constructeur. - Die technische Angaben die Merkmale und die Bilder sind weisend und verbinden nicht den Hersteller. - Los datos técnicos, las características y las ilustraciones son indicativas y no comprometen al constructor. - Технические характеристики, спецификации и иллюстрации носят ознакомительный характер и не являются обязательными для производителя.