

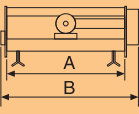

KRONOS



FALC

KRONOS						RUOTE ROUES WHEELS RÄDERN RUEDAS КОЛЕСАМИ	 **				G/M del rotore T/M du rotor Rotor's RPM Rotor U/M R/M de rotor Об/Мин. ротора
		HP	A mm.	B mm.	A inches	B inches	N.	KG	LBS	N.	N.
4000 DT/MR	100-160	4011	4425	157,91	174,21	2	2500	5511	88	1	1835
4800 DT/2R	100-160	4821	5235	189,80	206,10	2	2820	6217	104	2	1835
5400 DT/2R	120-180	5541	5955	218,15	234,44	2	3300	7275	120	2	1786
6400 DT/2R	120-180	6441	6855	253,58	269,88	4	3820	8422	144	2	1786
8000 DT/2R*	160-280	8018	8435	315,66	331,96	4	4840	10670	176	2	1721

DT = doppia trasmissione

MR = mono rotore

2R = doppio rotore

I * A richiesta **F** * Sur demande **GB** * On request **D** * Auf Wunsch **E** * A pedido **РУС** * По запросу

I ** Pesi con ruote **D** ** Gewicht mit Rädern
F ** Poids avec roues **E** ** Pesos con ruedas
GB ** Weights include wheels **РУС** ** Вес с колесами

I Cofani anteriori e posteriori apribili (con cerniere)
F Capots de fermeture avant et arrière (avec charnières)
GB Front and rear closing bonnets (hinged)
D Vordere und hintere Haube (aufklappbar)
E Capots delanteros y traseros que se pueden abrir (con goznes)
РУС Открывающийся передний и задний капот (с шарнирным соединением)

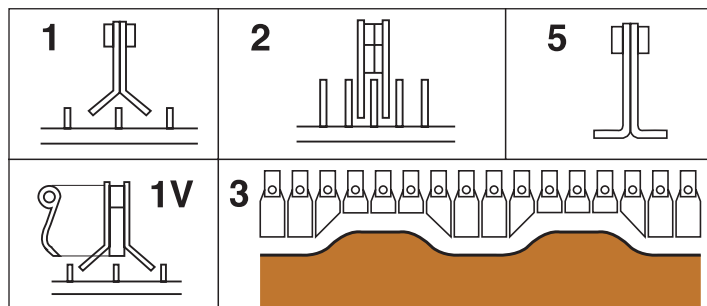
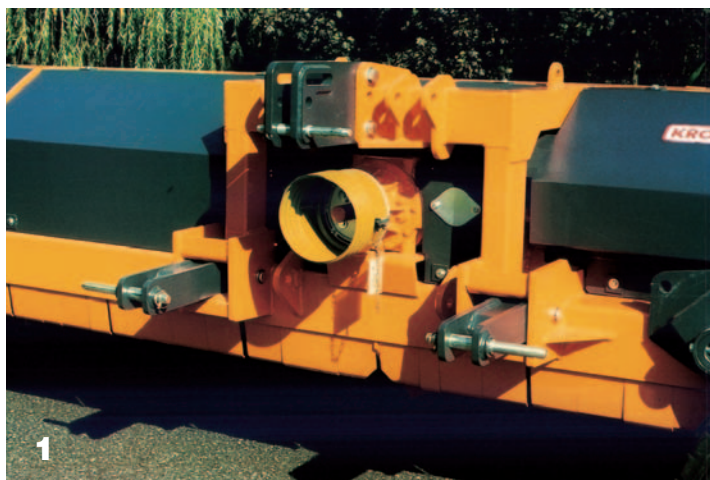

I VELOCITÀ PERIFERICA DEI COLTELLI **D** MESSERSUMFANGSGESCHWINDIGKEIT
F VITESSE PERIPHERIQUE DES COUTEAUX **E** VELOCIDAD PERIFERICA DE LAS CUCHILLAS
GB TIP SPEED OF BLADES **РУС** ПЕРИФЕРИЧЕСКАЯ СКОРОСТЬ НОЖЕЙ

SERIE	m/sec	inch/sec
KRONOS 4000-4800	70	2756
KRONOS 5400-6400	68	2677
KRONOS 8000	66	2598



100-280 HP.

KRONOS

HÄCKSLER **D**
DESBRUZADORA **E**
ИЗМЕЛЬЧИТЕЛЬ **PVC**

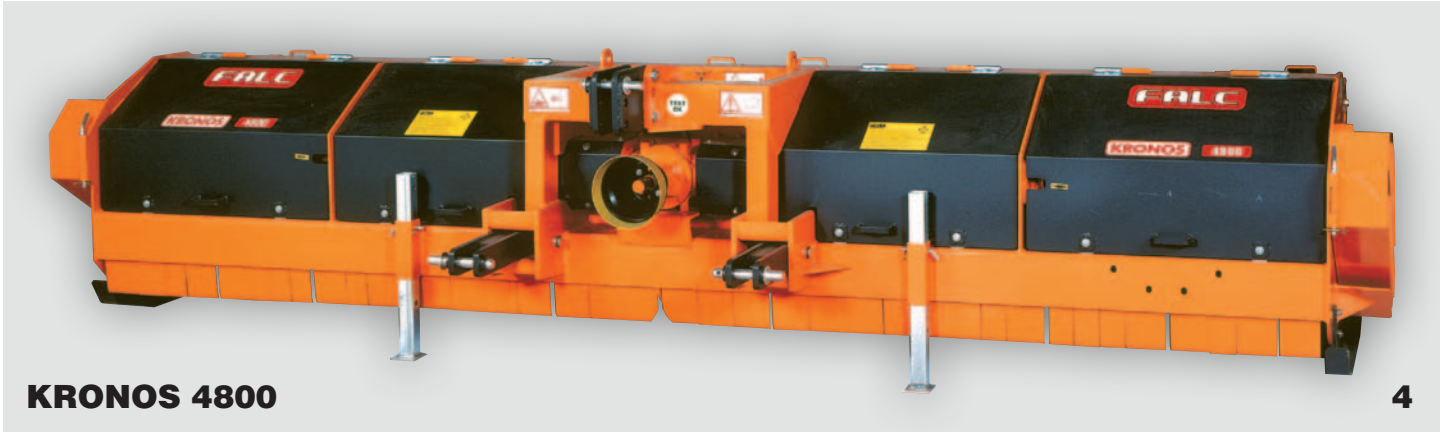

KRONOS 4800

4

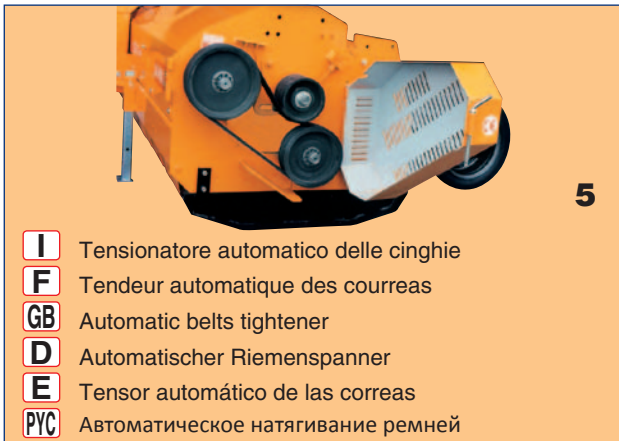

5

- I** Tensionatore automatico delle cinghie
- F** Tendeur automatique des courreas
- GB** Automatic belts tightener
- D** Automatischer Riemenspanner
- E** Tensor automático de las correas
- PVC** Автоматическое натягивание ремней



6



7

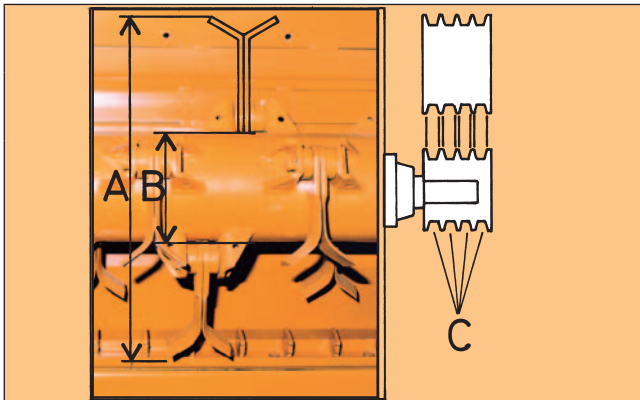

A	Ø mm 728 (inches 28,66)
B	Ø mm 298,5 x 10 (inches 11,75 x 0,39)
C	<p>N° 4 + 4 = KRONOS 4000 MONOROTORE 2 TRASMISSIONI</p> <p>N° 4 + 4 = KRONOS 4800 2 ROTORI 2 TRASMISSIONI</p> <p>N° 5 + 5 = KRONOS 5400 2 ROTORI 2 TRASMISSIONI</p> <p>N° 5 + 5 = KRONOS 6400 2 ROTORI 2 TRASMISSIONI</p> <p>N° 6 + 6 = KRONOS 8000 2 ROTORI 2 TRASMISSIONI</p>

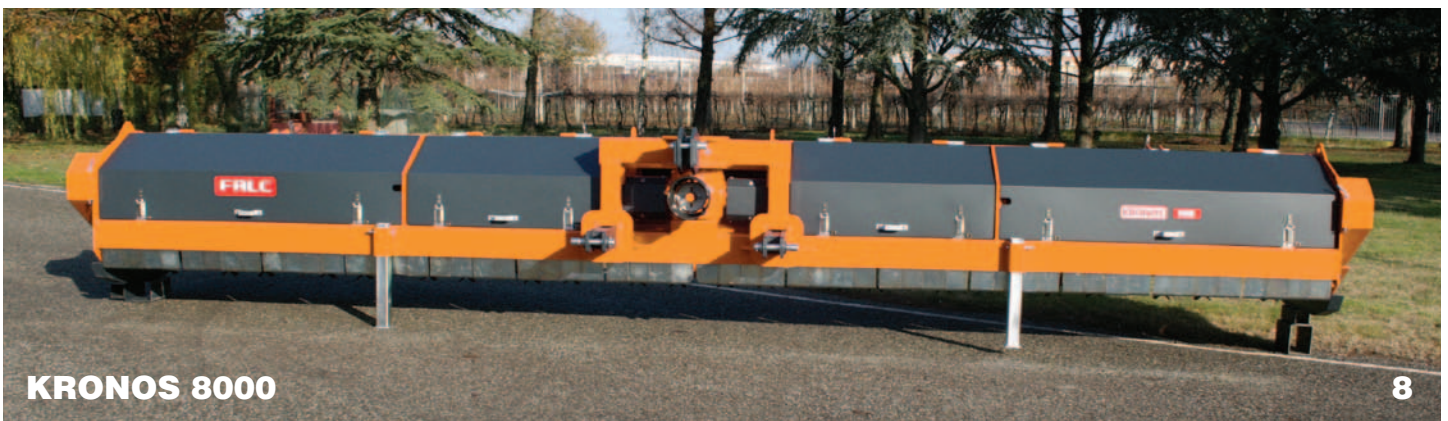

KRONOS 8000

8

- I** Possibilità di montare la lamiera d'usura
- D** Ausstattung des Verschleißblech möglich
- F** Possibilité de monter la tôle d'usage
- E** Este modelo permite montar chapa para prevenir el desgaste
- GB** Possibility to assemble a wear & tear plate
- PVC** Возможность установки листового износа

I TRINCIA
F BROYEUR
GB SHREDDER

KRONOS

D HÄCKSLER
E DESBROZADORA
PVC ИЗМЕЛЬЧИТЕЛЬ



KRONOS 4800

9

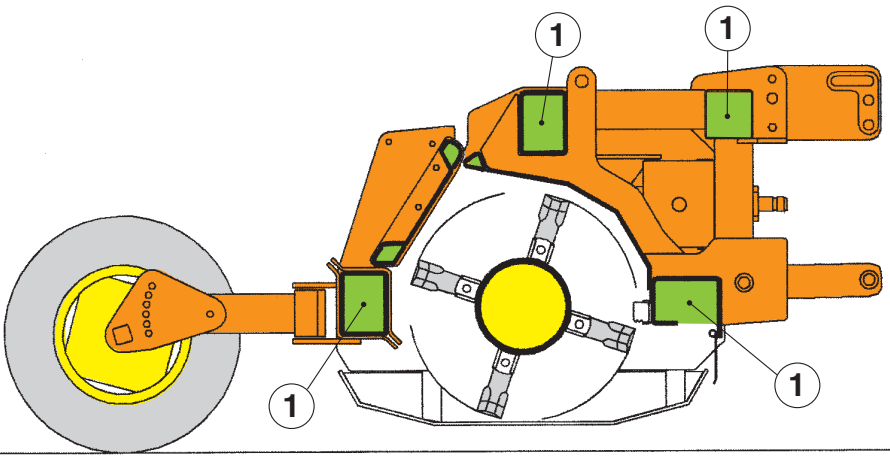

- I** Elementi della struttura che rendono il telaio indeformabile.
- F** Eléments de chassis rendant l'ensemble de la structure indeformable.
- GB** Reinforced frame eliminates risk of distortion.
- D** Rahmenteile, welche dem Chassis eine grosse Stabilität verleihen.
- E** Elementos de construcción que aseguran un chasis indeformable.
- PVC** Элементы структуры, которые делают шасси недеформируемыми

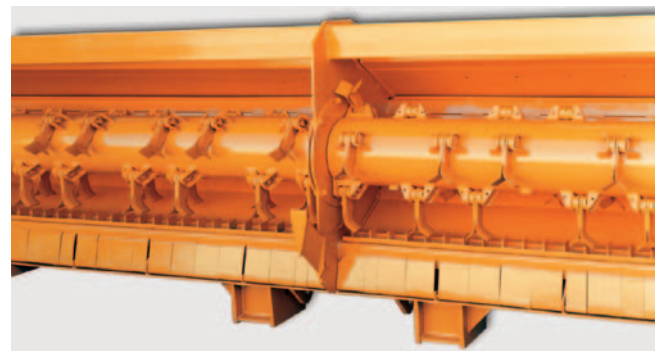

- I** N° 2 Rotori
- F** N° 2 Rotors
- GB** N° 2 Rotors
- D** N° 2 Rotoren
- E** N° 2 Rotores
- PVC** N° 2 Ротора

FALC - Via Proventa, 41 - 48018 FAENZA (ITALIA) - e-mail: info@falc.eu - www.falc.eu



Numero nazionale:

International number:

Tel. 0546 29050
 Fax 0546 663986

Tel. +39 0546 29050
 Fax +39 0546 663986

