



**TRINCIA
BROYEUR
SHREDDER
HÄCKSLER
DESBROZADORA
ИЗМЕЛЬЧИТЕЛЬ**

FALC[®]



CAT







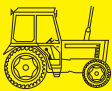
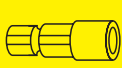

FALC[®]

-  È ideale per la trinciatura di erba e potature leggera
-  Il est idéal pour le broyage d'herbes et sarments légers
-  It is ideal for the cutting of grass and light prunings







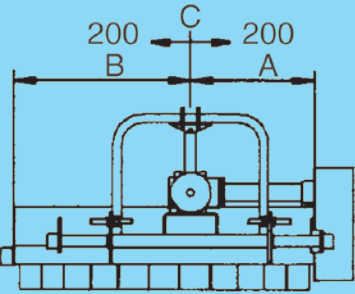

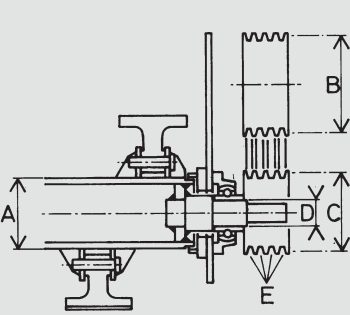
CAT SP SPOSTABILE						
			HP.	PTO	KG	LBS
1350	20 - 60	540	353	778	36	18
1500	30 - 60	540	374	824	40	20
1800	40 - 60	540	417	919	48	24
2100	50 - 60	540	468	1032	56	28
2500	50 - 60	540	550	1213	68	34

-  ATTACCO CON SPOSTAMENTO IDRAULICO
-  ATTELAGE AVEC DEPLACEMENT HYDRAULIQUE
-  HYDRAULIC OFFSET LINKAGE
-  ANSCHLUß MIT HYDRAULISCHEM SEITENSCHUB
-  ÉNGANCHE CON DESPLAZAMIENTO HIDRÁULICO
-  ГИДРАВЛИЧЕСКИМ СМЕЩЕНИЕМ

	CAT SP	A mm.	B mm.	A inches	B inches	C	
	1350	570	812	22,44	31,96	- spostamento - déplacement - offset mm. 400	- Seitenschuß - desplazamiento - перемещение inches 15,748
1500	570	954	22,44	37,55			
1800	570	1238	22,44	48,74			
2100	570	1522	22,44	59,92			
2500	905	1613	35,63	63,50			

	A Ø mm. 121	inches 4,763
	A Ø mm. 194 x mod. 2500	inches 7,637
	B Ø mm. 200	inches 7,874
	C Ø mm. 160	inches 6,299
	D Ø mm. 40	inches 1,574
E	N° 3 MOD. 1350 - 1500 - 1800	
	N° 4 MOD. 2100 - 2500	

-  GIRI AL MINUTO DEL ROTORE
-  TOURS A LA MINUTE DU ROTOR
-  ROTOR'S RPM
-  ROTORHUMDREUNGEN IN DER MINUTE
-  ROTACIONES AL MINUTO DEL ROTOR
-  ОБ/МИН ПОТОРА

N. 2025



- Er eignet sich hervorragend für das Häckseln von Unkraut, Ästen und Stauden
- Es ideal para el trinchado de hierbas y de podas livinianas
- Идеально подходит для кошения травы и легкой обрезки



CAT F FISSO						
			HP.	PTO		
800*	20 - 60	540	260	573	20	10
1000*	20 - 60	540	280	617	28	14
1200*	20 - 60	540	300	661	32	16
1350	20 - 60	540	315	694	36	18
1500	30 - 60	540	340	750	40	20
1800	40 - 60	540	380	838	48	24
2100	50 - 60	540	430	948	56	28
2500*	50 - 60	540	510	1124	68	34

* A RICHIESTA - * SUR DEMANDE - * ON REQUEST - * AUF WUNSCH - * A PEDIDO - * ПО ЗАПРОСУ

- ATTACCO FISSO CON 2 POSIZIONI (ESCLUSO 800-1000-1200)
- ATTELAGE FIXE A 2 POSITIONS (EXCLU 800-1000-1200)
- FIX LINKAGE WITH 2 POSITIONS (EXCLUDED 800-1000-1200)
- FESTER ANSCHLUß MIT 2 POSITIONEN (AUSSCHLIESSLICH 800-1000-1200)
- ENGANCHE FIJO CON 2 POSICIONES (EXCLUIDO 800-1000-1200)
- ФИКСИРОВАННОЕ КРЕПЛЕНИЕ С 2 ПОЛОЖЕНИЯМИ (ЗА ИСКЛЮЧЕНИЕМ 800-1000-1200)

	CAT F	A	B	A	B
		mm.	mm.	inches	inches
800	407	407	16,02	16,02	
1000	513,5	513,5	20,22	20,22	
1200	607	633	23,90	24,92	

- PREDISPOSIZIONE PER RASTRELLO POSTERIORE. (ESCLUSO 2100-2500)
- DISPOSITION POUR RÂTEAU POSTÉRIEUR. (EXCLU 2100-2500)
- FACILITY FOR REAR RAKE (EXCLUDED 2100-2500)
- VORBEREITUNG FÜR HINTEREN RECHEN. (AUSSCHLIESSLICH 2100-2500)
- PREDISPOSICIÓN PARA RASTRILLADORA POSTERIOR. (EXCLUIDO 2100-2500)
- ПРЕДРАСПОЛОЖЕНИЕ ДЛЯ ГРАБЛЕЙ (ЗА ИСКЛЮЧЕНИЕМ 2100-2500)

	CAT F	A	B	C	D	A	B	C	D
		mm.	mm.	mm.	mm.	inches	inches	inches	inches
1350	745	637	388	994	29,33	25,08	15,28	39,13	
1500	745	779	388	1136	29,33	30,67	15,28	44,72	
1800	745	1063	388	1420	29,33	41,85	15,28	55,91	
2100	745	1347	388	1704	29,33	53,03	15,28	67,09	
2500	1270	1248	912	1606	50,00	49,13	35,91	63,23	

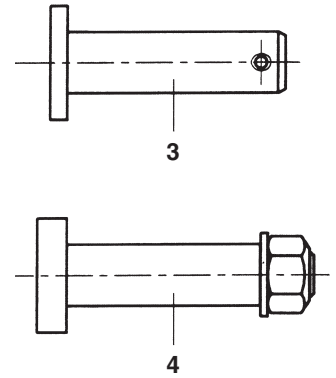
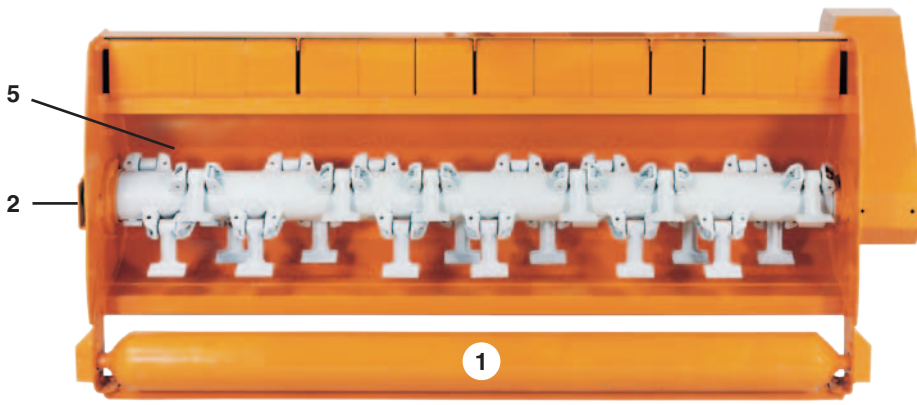

1. Rullo posteriore regolabile in altezza Ø 140 mm.
2. Cuscinetti rotore UCF 208 (Ø perno 40 mm).
3. Perno standard in acciaio temperato.
4. Perno per terreni sassosi.
5. Lamiera telaio spessore 5 mm.

A richiesta ruote anteriori di appoggio (regolabili in altezza): col rullo posteriore (1) permettono una costante sicura altezza di taglio. Il CAT "diventa" trainato.



1. Rouleau arrière réglable en hauteur Ø 140 mm.
2. Roulements rotor UCF 208 (Ø axe 40 mm).
3. Axe standard en acier trempé.
4. Axe pour terrains caillouteux.
5. Tôle châssis épaisseur 5mm.

Sur demande roues avant d'appui (réglables en hauteur): avec rouleau arrière (1) elles permettent une constante sûre hauteur de coupe.



1. Rodillo posterior regulable en altura Ø 140 mm.
2. Cojinetes rotores UCF 208. (Ø perno 40 mm).
3. Perno standard em acero templado.
4. Perno para terrenos pedregosos.
5. Palastro (chapa) chasis espesor 5 mm.

A pedido ruedas anteriores de apoyo (regulables en altura): con el rodillo posterior (1) permiten una constante y segura altura de corte.



1. Rear roller is adjustable in height; Ø 140 mm [inches 5,51].
2. Rotor bearings UCF 208 (pin Ø 40 mm) [inches 1,57].
3. Standard pin in hardened steel.
4. Pin for stony soils.
5. Frame sheet thickness 5 mm [inches 0,20].

On request front support wheels (adjustable in height): with rear roller (1), they allow a steady cutting height The CAT "becomes" towed.



1. Задний ролик регулируемый по высоте Ø 140 мм.
2. Подшипники ротора UCF 208 (Ø штифта 40 мм)
3. Стандартный штифт из закаленной стали
4. Штифт для каменистых почв
5. ощина металлического листа каркаса 5 мм.

По просьбе передние колеса поддержки (регулируемые по высоте): с задним роликом (1) позволяют иметь постоянную безопасную высоту косы. CAT можно брать на буксир.

FALC - Via Proventa, 41 - 48018 FAENZA (ITALIA) - e-mail: info@falc.eu - www.falc.eu



Numero nazionale:

Tel. 0546 29050
Fax 0546 663986

International number:

Tel. +39 0546 29050
Fax +39 0546 663986

