

**2020-2021
PRODUCTION**



FALC

1960-2020

60th ANNIVERSARY

FALC





1960-2020





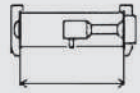



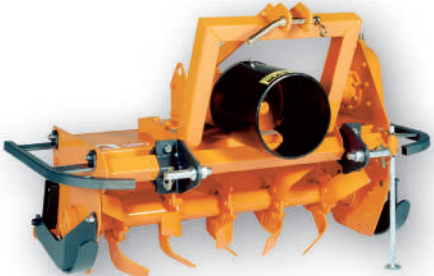

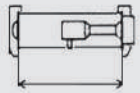

WORLD WIDE DEALER NETWORK





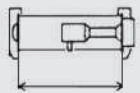





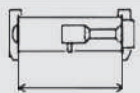

ROTARY TILLERS - FRÄSEN - ФРЕЗЫ - FREZEN

A							 540
	HP.	mm.	inches	KG	LBS	N.	
900	15-30	875	34,44	160	353	20	
1100	15-30	1055	41,53	170	375	24	
1250	20-30	1246	49,05	180	397	28	
1450	20-30	1435	56,49	190	419	32	
1650	25-30	1625	63,97	200	441	36	



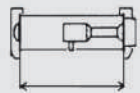

BS							 540
	HP.	mm.	inches	KG	LBS	N.	
900	20-50	922	36,29	195	430	20	
1100	20-50	1092	42,99	224	494	24	
1250	25-50	1263	49,72	234	516	28	
1450	30-50	1432	56,37	246	542	32	
1550	35-50	1548	60,94	266	586	36	
1650	40-50	1642	64,64	276	608	36	



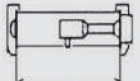

CS							 540
	HP.	mm.	inches	KG	LBS	N.	
1300	40-70	1340	52,75	380	838	30	
1500	40-70	1495	58,85	400	882	36	
1600	50-70	1585	62,40	420	926	36	
1800	50-70	1830	72,04	450	992	42	
2100	60-70	2090	82,28	490	1080	48	



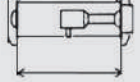

D							 540
	HP.	mm.	inches	KG	LBS	N.	
1600	60-100	1576	62,04	540	1191	36	
1800	60-100	1821	71,69	590	1300	42	
2100	60-100	2066	81,33	640	1411	48	
2300	60-100	2311	90,98	700	1543	54	
2500	60-100	2556	100,63	740	1631	60	



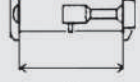

HD							 540
	HP.	mm.	inches	KG	LBS	N.	
1600	60-100	1576	62,04	560	1234	36	
1800	60-100	1821	71,69	615	1355	42	
2100	60-100	2066	81,33	660	1455	48	
2300	60-100	2311	90,98	710	1565	54	
2500	60-100	2556	100,63	750	1653	60	
2800	60-100	2801	110,27	790	1741	66	



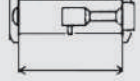

ROTARY TILLERS - FRÄSEN - ФРЕЗЫ - FREZEN

EL								540-1000
	HP.	mm.	inches	KG	LBS	N.	N.	
2500	60-120	2615	102,95	885	1951	44	60	
3000	60-120	3115	122,64	1005	2216	50	72	

FL								1000
	HP.	mm.	inches	KG	LBS	N.	N.	
3000	100-160	3115	122,64	1200	2646	60	72	

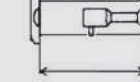



GL								1000
	HP.	mm.	inches	KG	LBS	N.	N.	
3000	130-220	3115	122,64	1480	3263	60	72	
3500	140-220	3615	142,32	1685	3715	70	84	





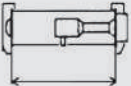



GSL								1000
	HP.	mm.	inches	KG	LBS	N.	N.	
4000	150-240	4115	162,00	1940	4277	80	96	
4500	160-240	4615	181,69	2120	4674	90	108	

KAPPA								1000
	HP.	mm.	inches	KG	LBS	N.	N.	
4000	190-300	4115	162,00	2690	5930	80	96	
4500	190-300	4615	181,69	3090	6812	90	108	
6000 DT*	190-300	6322	248,89	3920	8642	120	144	

 * ON REQUEST -  * AUF WUNSCH -  * ПО ЗАПРОСУ -  * OP AANVRAAG





ROTARY TILLERS - FRÄSEN - ФРЕЗЫ - FREZEN

RU						N.	 1000
	HP.	mm.	inches	KG	LBS		
3100 *	150-300	3115	122,64	1850	4078	72	
3600 *	150-300	3615	142,32	2060	4541	84	
4100 *	150-300	4115	162,00	2240	4938	96	
4100 DT *	180-300	4115	162,00	2470	5445	96	
4600 DT *	180-300	4615	181,69	2620	5776	108	
4850 DT *	180-300	4865	191,53	2700	5952	120	

 * ON REQUEST -  WEIGHT WITHOUT ROLLER
  * AUF WUNSCH -  GEWICHT OHNE WALZE
 * ПО ЗАПРОСУ -  ВЕС БЕЗ КАТКОМ
  * OP AANVRAAG -  GEWICHT ZONDER ROL

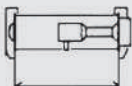
FOLDING ROTARY TILLER - KLAPPBARER FRÄSE СКЛАДНАЯ ФРЕЗА - ОРКЛАПВАРЕ FREZEN

New

Gamma				 Ø 550				 50 K	
	HP.	mm.	inches	KG	LBS	mm.	inches	N.	N.
4600 *	180-380	4530	178,35	3890	8576	2796	110,08	82	108
5000 *	180-380	5030	198,03	4090	9017	2796	110,08	92	120
5400 *	200-380	5400	212,60	4340	9568	2796	110,08	/	132
6000	200-380	6030	237,40	4490	9899	2796	110,08	112	144
7000 *	240-380	7030	276,77	4940	10890	2796	110,08	132	168

 * ON REQUEST -  * AUF WUNSCH -  * ПО ЗАПРОСУ -  * OP AANVRAAG

 1000







SUBSOILERS - TIEFENLOCKERER - ГЛУБОКОРЫХЛИТЕЛИ - WOELERS



 Combinable with rotary tillers and power harrows
 Für Anbau an Fräsen und Kreiseleggen
 Агрегатируемые с фрезами и роторными боронами
 Combineerbaar met frees en rotorkoepg

ROTARY TILLERS - FRÄSEN - ФРЕЗЫ - FREZEN

Cultiline		 foto 2			540 
	HP.	KG	LBS	N.	
1300	60-80	674	1486	34	 ①
1600	60-80	720	1588	40	



With compacting roller (photo 1)
With motorized hydraulic roller (photo 2)
With bed former (photo 3)



Mit Verdichtungswalze (Foto 1)
Mit hydraulischer motorisierter Walze (Foto 2)
Mit Beetformer (Foto 3)



С прикатывающим катком (фото 1)
С катком с гидроприводом (фото 2)
С грядоформирователем (фото 3)







Met verdichtingsrol (foto 1)
Met aangedreven hydraulische rol (foto 2)
Met bedvormer (foto 3)

MOTORIZED ROLLERS
MOTORIZIERTE WALZE
КАТОК С ГИДРОПРИВОДОМ
AANGEDREVEN ROL

BEDS FORMER
BEETFORMER
КОЖУХ С ГРЯДОФОРМИРОВАТЕЛЕМ
RUGVORMER

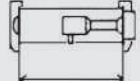





BURIER FOR STONES AND VEGETAL RESIDUALS UMKEHRFRÄSE ЗАКАПЫВАТЕЛИ ДЛЯ КАМНЕЙ И ОСТАТКОВ РАСТЕНИЙ OVERTOPFREES VOOR STENEN EN GROENMASSA





Reverse									
	HP.	mm.	inches	KG	LBS	KG	LBS	N.	N.
1500	80-120	1500	59,06	850	1874	233	514	31	42
1700	80-120	1700	66,93	940	2072	258	569	41	48
1850	80-120	1850	72,83	1010	2227	280	618	45	54
2000	80-120	2000	78,74	1070	2359	303	668	49	54
2300	90-120	2300	90,55	1180	2601	348	768	56	60
2500 *	100-120	2500	98,43	1320	2910	380	838	61	66

 * ON REQUEST -  * AUF WUNSCH -  * ПО ЗАПРОСУ -  * OP AANVRAAG





ROTARY TILLERS - FRÄSEN - ФРЕЗЫ - FREZEN

Ypsilon					 540
	HP.	KG	LBS	N.	
1600	40-65	500	1102	36	
1800	50-65	530	1168	42	
2100	55-65	560	1235	48	

 Rotary tiller with hydraulic automatic side shift  Fräse mit automatischer Verschiebung
 С автоматическим гидравлическим перемещением  Frees met automatische side shift

"BIO" ROTARY TILLER - "BIO" BODENFRÄSE ФРЕЗА "BIO" - "BIO" FREES

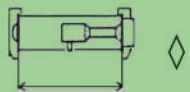
New

"BIO"					Without wheels ohne Räder без колес zonder wielen	
	HP.	mm.	inches	KG	LBS	N.
BIO FL 3000	100-160	3115	122,64	1200	2646	72
BIO GL 3000	130-220	3115	122,64	1480	3263	72
BIO GL 3500	130-220	3615	142,32	1685	3715	84
BIO GSL 4000	150-240	4115	162,00	1940	4277	96
BIO GSL 4500	150-240	4615	181,69	2120	4674	108
BIO KAPPA 4000	190-300	4115	162,00	2200	4850	96
BIO KAPPA 4500	190-300	4615	181,69	2500	5512	108
BIO KAPPA 6000 DT	190-300	6322	248,89	3300	7275	144
BIO GAMMA 6000/P	180-380	6030	237,40	3500	7716	144

 ◇ Width of the machine, without wheels

 ◇ Breite der Maschine, ohne Räder

 ◇ Рабочая ширина, без колес

 ◇ Breedte van de machine, zonder wielen

 "BIO" rotary tiller with special rotor type "S": destruction of grass and crop residues without the use of chemical herbicides

 Fräse "BIO" mit Spezialrotor Typ "S": Präzise mechanische Unterbrechung jeglichen Pflanzenwachstums



 Фреза "BIO" со специальным ротором типа "S": для уничтожения травы и остатков сельскохозяйственных культур без использования химических противосорняковых препаратов.



 "BIO" frees met speciale rotor type "S": Optimaal vernietigen van gewas en gewasresten, zonder gebruik van chemi calien en herbiciden.

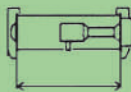

ROW CROPS ROTARY TILLER FRÄSE FÜR REIHENKULTUREN ФРЕЗА ДЛЯ РЯДКОВЫХ КУЛЬТУР RIJEN FREES



Strip-Till				Rows/Sections Reihe/Abschnitt Ряды/Секции Rijen - secties	Spacing Abstand Колесная база Tussenafstand		
	HP.	mm.	inches	N.	mm.	KG	LBS
3000 *	130-220	3115	122,64	4	750	2750	6063
	130-220	3115	122,64	6	500	2750	6063

 * ON REQUEST -  * AUF WUNSCH -  * ПО ЗАПРОСУ -  * OP AANVRAAG

 # WITH PACKER ROLLER 550 AND FRONT TINES

 # MIT PACKER WALZE UND TIEFENLOCKERER

 # 3 КАТКОМ ПАККЕР 550 И ПЕРЕДНИМИ ЗУБЬЯМИ

 # MET PACKERROL 550 EN FRONT TANDEN







 Depending on the width of the row, up to 70% of the soil surface is not worked. This not only protects the soil from erosion and drying, but also reduces working times and costs by creating a perfect seed bed for row crops, in a single pass. The tools work at a depth between 15 and 25 cm. and can easily adjusted to the desired depth.



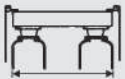

 Je nach Reihenbreite wird bis zu 70% der Bodenoberfläche nicht bearbeitet. Dies schützt nicht nur den Boden vor Erosion und Austrocknung, sondern reduziert auch Arbeitszeiten und Kosten, indem in einem Durchgang ein perfektes Saatbett für Reihenkulturen geschaffen wird. Die Werkzeuge arbeiten in einer Tiefe zwischen 15 un 25 cm und können einfach auf die gewünschte Tiefe eingestellt werden.



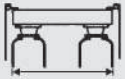

 В зависимости от предусмотренной ширины ряда, не будет обрабатываться до 70% поверхности почвы. Это не только защищает почву от эрозии и высыхания, но и уменьшает время и стоимость обработки, создавая эффект посевного ложа для рядковых культур за один проход. Рабочие органы работают на глубине от 15 до 25 см и могут легко регулироваться на желаемую глубину на которую должна обрабатываться почва.

 Afhankelijk van de breedte van de rij wordt tot 70% van het grondoppervlak niet bewerkt. Dit beschermt niet alleen de grond tegen erosie en uitdroging, maar vermindert ook de werktijden en kosten door in één keer een perfect zaaibed voor rijgewassen te creëren. De tanden werken op een diepte tussen 15 en 25 cm en kunnen eenvoudig worden aangepast aan de gewenste diepte.



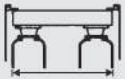

POWER HARROWS - KREISELEGGEN РОТОРНЫЕ БОРОНЫ - РОТОРКОПЕГ

Fox Vigneron							540	
	HP.	mm.	inches	KG	LBS	N.		
1000	40-90	1070	42,12	410	904	4	①	
1300	40-90	1316	51,81	450	992	5		
1500	40-90	1562	61,49	510	1124	6		
1800	40-90	1808	71,18	570	1257	7		

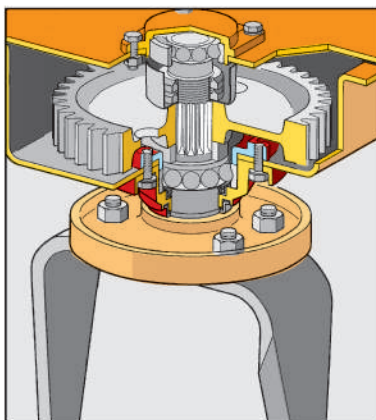
Fox Special							540	
	HP.	mm.	inches	KG	LBS	N.		
2000	50-100	2112	83,14	660	1455	8	②	
2300	50-100	2358	92,83	710	1565	9		
2500	50-100	2549	100,35	760	1675	10		
3000	50-100	3049	120,03	860	1895	12		







Fox							540-1000	
	HP.	mm.	inches	KG	LBS	N.		
2500	60-120	2553	100,51	945	2083	10	③	
3000	60-120	3053	120,20	1060	2337	12		



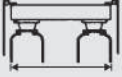







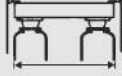



-  Power Harrows with ball bearings
-  Kreiseleggen mit Kugellagern
-  Роторные бороны с шариковыми подшипниками
-  Rotorkopeg met kogellagers



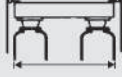



POWER HARROWS - KREISELEGGEN РОТОРНЫЕ БОРОНЫ - РОТОРКОПЕГ

Smart							 540-1000	
	HP.	mm.	inches	KG	LBS	N.		
3000	60-140	3091	121,69	1310	2888	12		①

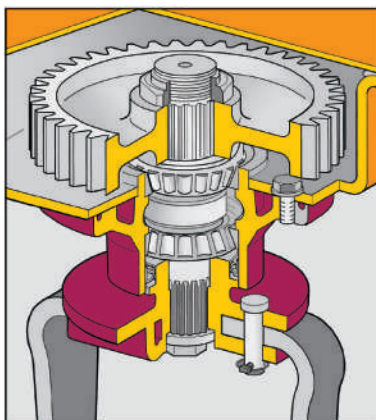
Kratos							 1000	
	HP.	mm.	inches	KG	LBS	N.		
3000	90-200	3115	122,64	1700	3747	12		②
3500	120-200	3607	142,01	1980	4365	14		
4000	130-200	4099	161,38	2200	4850	16		







Magnum							 1000	
	HP.	mm.	inches	KG	LBS	N.		
3000	100-240	3115	122,64	1730	3814	12		③
3500	120-240	3607	142,01	2020	4453	14		
4000	130-240	4099	161,38	2310	5093	16		
4500	150-240	4591	180,75	2600	5732	18		
5000	160-240	5083	200,12	2890	6371	20		



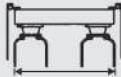







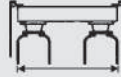

-  Power Harrows with tapered roller bearings
-  Kreiseleggen mit grossen Kegelrollenlagern
-  Роторные бороны с коническими роликовыми подшипниками
-  Rotorkopeg met axiaallagers





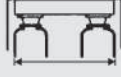



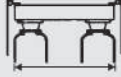

FOLDING POWER HARROWS - KLAPPBARE KREISELEGGEN СКЛАДНЫЕ РОТОРНЫЕ БОРОНЫ - ОРКЛАПВААР РОТОРКОРЕГ

Fox/P							1000	
	HP.	mm.	inches	KG	LBS	N.		
4000/P	140-200	4057	159,72	1700	3748	16		①
5000/P	140-200	5041	198,46	2150	4740	20		

Kratos/P							1000
	HP.	mm.	inches	KG	LBS	N.	
4000/P	140-240	4128	162,52	2790	6150	16	
5000/P	140-240	5112	201,25	3210	7076	20	
6000/P	140-240	6096	240,00	3690	8135	24	



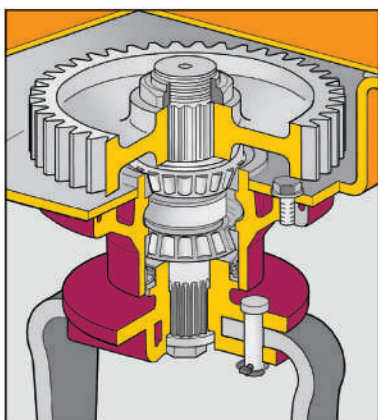

Magnum/P							1000
	HP.	mm.	inches	KG	LBS	N.	
5000/P	160-240	5112	201,25	3650	8046	20	
6000/P	170-240	6096	240,00	4440	9788	24	

Super Magnum/P							1000
	HP.	mm.	inches	KG	LBS	N.	
5000/P	160-350	5112	201,25	3770	8311	20	
6000/P	170-350	6096	240,00	4570	10075	24	
7000/P *	170-350	7080	278,75	4920	10847	28	





 * ON REQUEST -  * AUF WUNSCH -  * ПО ЗАПРОСУ -  * OP AANVRAAG







Mod: Kratos/P - Magnum/P - Super Magnum/P

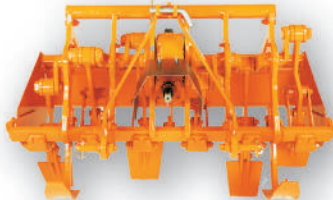

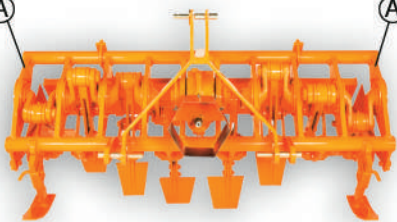

-  Power Harrows with tapered roller bearings
-  Kreiseleggen mit grossen Kegelrollenlagern
-  Роторные бороны с коническими роликовыми подшипниками
-  Rotorkoepg met axiaallagers

DIGGING MACHINES - SPATENMASCHINEN ПОЧВОРЫХЛИТЕЛИ - KRUKAS SPITMACHINE

Panda									540	
	HP.	mm.	inches	mm.	inches	KG	LBS	N.		
1000	20-35	997	39,25	220	8,66	225	496	4	①	
1300	20-35	1307	51,45	220	8,66	310	683	6		
1500	20-35	1477	58,15	220	8,66	330	727	6		

Mini Toro									540	
	HP.	mm.	inches	mm.	inches	KG	LBS	N.		
1000	30-60	1004	39,53	250	9,84	380	837	4	②	
1200	30-60	1165	45,87	250	9,84	395	870	4		
1300	40-60	1412	55,59	250	9,84	480	1058	6		
1500	40-60	1508	59,37	250	9,84	500	1102	6		
1700	45-60	1684	66,30	250	9,84	520	1146	6		
1800	50-60	1818	71,57	250	9,84	590	1300	8		
2000	50-60	1952	76,85	250	9,84	610	1344	8		

 (A) External flanges on request
  (A) Seitenflanschen auf Wunsch
 (A) Наружные фланцы по запросу
  (A) Externe flenzen op aanvraag

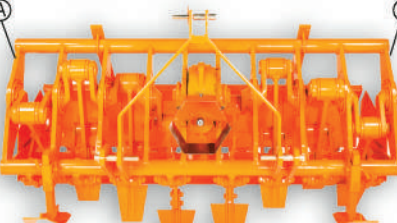
Toro									540	
	HP.	mm.	inches	mm.	inches	KG	LBS	N.		
1500	40-90	1504	59,21	350	13,78	675	1488	6	③	
1700	45-90	1680	66,14	350	13,78	710	1565	6		
1800	60-90	1814	71,42	350	13,78	830	1829	8		
2000 (A)	60-90	1958	77,09	350	13,78	880	1940	8		
2200 (A)	70-90	2210	87,01	350	13,78	1080	2380	10		
2500 (A)	70-90	2480	97,64	350	13,78	1120	2469	10		







 (A) Standard external flanges
  (A) Standard Seitenflanschen
 (A) Серийные наружные фланцы
  (A) Standaard externe flenzen

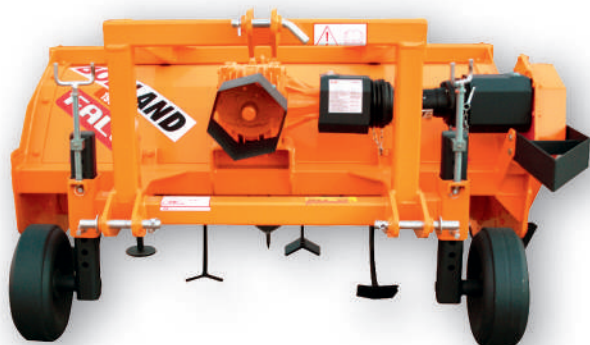

ROTARY PLOUGHS - ROTATIONSPFLUG РОТОРНЫЕ ПЛУГИ - ROTERENDE SPITMACHINE

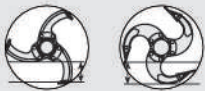





Bobland

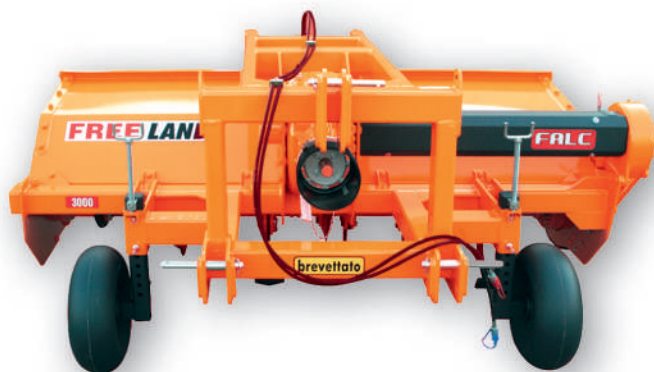

Bobland									
	mm.	inches	KG	LBS	mm.	inches	N.	HP.	PTO
1900	1900	74,80	960	2116	350	13,78	11	80-120	540
2100	2100	82,67	1260	2778	350	13,78	12	90-120	540
2350	2350	92,52	1460	3219	350	13,78	14	100-120	540
2500	2500	98,43	1650	3638	350	13,78	15	100-120	540

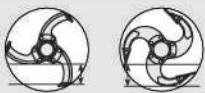
Freeland



Freeland									
	mm.	inches	KG	LBS	mm.	inches	N.	HP.	PTO
2500 *	2869	112,95	2460	5423	350	13,78	16	110-180	540
3000	3199	125,94	2610	5754	350	13,78	18	130-180	540
3000	3199	125,94	2610	5754	350	13,78	18	130-230	1000
4000	4199	165,32	3230	7121	350	13,78	24	180-230	1000

 * ON REQUEST -  * AUF WUNSCH -  * ПО ЗАПРОСУ -  * OP AANVRAAG

ROTARY PLOUGHS - ROTATIONSPFLUG РОТОРНЫЕ ПЛУГИ - ROTERENDE SPITMACHINE

Falcland

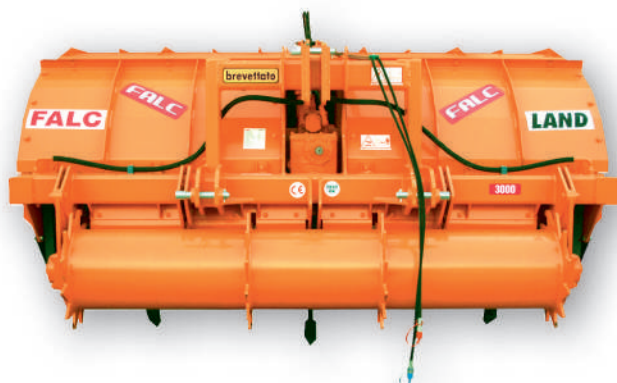

Falcland									
	mm.	inches	KG	LBS	mm.	inches	N.	HP.	PTO
3000	3190	125,59	4100	9039	450	17,71	18	240-300	1000

The rotary plough allows operating in extremely wet conditions so as extremely dry, obtaining a very good feed speed and optimal result. Moreover the advantages of the rotary plough are: the problem of furrows to close is eliminated, the problem of the forming of macrosod is eliminated, the rest of cultivations are mixed in a homogeneous way; the soil is soft. Elimination of a deep compact layer of earth that prevents the penetration of water and roots. Reduced wear and tear of tyres (zero slipping); towing force is eliminated. Improve of soil's oxygenation and fertility. The employment of the power through the PTO improves the tractor's performance.

Der Rotationspflug leistet auch bei extremer Feuchtigkeit oder Trockenheit hervorragende Arbeit, sowohl die Geschwindigkeit als auch das Ergebnis betreffend. Die Vorteile des Rotationspflug sind u.a.: Furchenschließung und Großhollenbildung wird verhindert, die Erde wird gleichmassig vermischt und der Boden bleibt locker. Verhinderung von Großen Schollen unterhalb der Oberfläche welche das Durchdringen von Wasser und Wurzeln behindert. Niedriger Ressourcenverbrauch, z.B. geringerer Reifenverschleiß (kein Schlüpf); keine Zugkraft wird benötigt, bessere Aufnahme von Sauerstoff und somit Erhöhung der Fruchtbarkeit des Bodens. Die Verwendung der Kraft durch die Zapfwelle verbessert die Traktorleistung.

Роторный плуг способен работать в условиях высокой влажности или сильно твердых сухих почв с высокой скоростью, показывая отличный результат. При использовании роторного плуга исключается проблема закрытия борозд, не образуются большие комья земли, пожнивные остатки смешиваются до образования однородной массы, земля остается рыхлой. На почве не образуется «плотная гладкая подошва», которая препятствует проникновению воды и корней. Сокращен износ шин (нет буксировки); снижена сила тяги. Улучшается насыщение почвы кислородом, повышается степень плодородия. Использование мощности через вал отбора мощности повышает производительность трактора.

De roterende spitmachine maakt het mogelijk om in extreem natte omstandigheden te werken, en ook in extreem droge omstandigheden. Bovendien zijn de voordelen van een spitmachine, geen eindvoren en perceel gelijk afgewerkt. De bodem wordt homogeen bewerkt zonder storende lagen. Beter waterdoorlatende eigenschappen, en capillaire werking. Geen trekkracht nodig, en minder slijtage aan de banden. Door de roterende werking van de rotor ook in natte omstandigheden tractie.

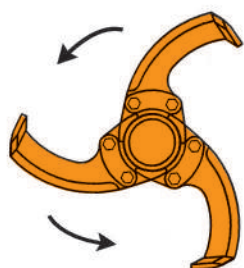



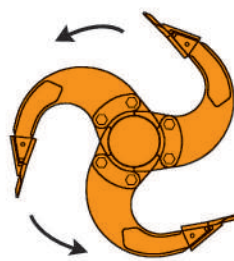







Rotary convex shares for wet soils.
 Konvexen Rotationszinken für nassen Böden.
 Дугообразные вращающиеся лемеха для влажных почв.
 Spittanden voor natte omstandigheden.







Rotary concave tines for tough dry soils.
 Konkave Rotationszinken für trockene Böden.
 Вогнутые вращающиеся зубья для твердых сухих почв.
 Spittanden voor droge omstandigheden.

SHREDDERS for open fields - HÄCKSLER für offenes Feld ИЗМЕЛЬЧИТЕЛИ - KLEPELMAAIERS voor open velden





Agila							540
	HP.	mm.	inches	KG	LBS	N.	
1600	50-100	1581	62,24	660	1455	32	
1800	50-100	1761	69,33	706	1556	36	
2100	50-100	2121	83,50	750	1653	44	
2300	50-120	2305	90,75	910	2006	48	
2500	50-120	2485	97,83	965	2127	52	
2700	50-120	2665	104,92	1020	2249	56	
3000	50-120	3025	119,09	1080	2380	64	



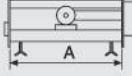

Unika							540-1000
	HP.	mm.	inches	KG	LBS	N.	
2100	50-100	2121	83,50	751	1656	44	
2300	50-120	2305	90,75	887	1955	48	
2500	50-120	2485	97,83	926	2041	52	
2700	50-120	2665	104,92	968	2134	56	







Unika Sp.							540-1000
	HP.	mm.	inches	KG	LBS	N.	
2300	70-120	2305	90,75	840	1851	48	
2500	70-120	2485	97,83	880	1940	52	
2700	70-120	2665	104,92	920	2028	56	
3000	70-120	3025	119,09	980	2160	64	













SHREDDERS for open fields - HÄCKSLER für offenes Feld ИЗМЕЛЬЧИТЕЛИ - KLEPELMAAIERS voor open velden





Wind							 1000
	HP.	mm.	inches	KG	LBS	N.	
2700	70-160	2665	104,92	1326	2923	56	
3200	70-160	3184	125,35	1441	3177	68	
3200/DT	70-160	3184	125,35	1681	3706	68	
3600	70-160	3655	143,90	1566	3452	80	
4000	70-160	4015	158,07	1671	3684	88	
6000/DT *	100-160	6081	239,41	2700	5952	136	

 * ON REQUEST -  * AUF WUNSCH -  * ПО ЗАПРОСУ -  * OP AANVRAAG

Vision							 1000
	HP.	mm.	inches	KG	LBS	N.	
2700	70-160	2665	104,92	1196	2637	56	
3200	70-160	3184	125,35	1316	2901	68	
3600	70-160	3655	143,90	1440	3175	80	
4000	70-160	4015	158,07	1545	3406	88	





 * ON REQUEST -  * AUF WUNSCH -  * ПО ЗАПРОСУ -  * OP AANVRAAG





Kronos							 1000
	HP.	mm.	inches	KG	LBS	N.	
4000 DT	100-160	4011	157,91	2500	5511	88	
4800 DT	100-160	4821	189,80	2820	6217	104	
5400 DT	120-180	5541	218,15	3300	7275	120	
6400 DT	120-180	6441	253,58	3820	8422	144	
8000 DT *	160-280	8018	315,66	4840	10670	176	

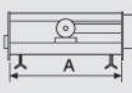



 * ON REQUEST -  * AUF WUNSCH -  * ПО ЗАПРОСУ -  * OP AANVRAAG





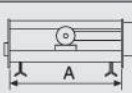

FOLDING SHREDDERS for open fields
KLAPPBARE HÄCKSLER für offenes Feld
СКЛАДНЫЕ ИЗМЕЛЬЧИТЕЛИ
OPKLAPBARE KLEPELMAAIERS voor open velden

Atlas/P								
	HP.	mm.	inches	mm.	inches	KG	LBS	N.
4000/P	100-160	2200	86,61	4086	160,87	1580	3483	44
5000/P	100-160	2200	86,61	4986	196,30	1830	4034	52
6000/P	100-160	2200	86,61	6066	238,82	2090	4607	64

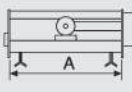

 ° WEIGHT WITH ROLLER -  ° GEWICHT MIT WALZE -  ° ВЕС С КАТКОМ -  ° GEWICHT MET ROL

Agila 5000/P								
	HP.	mm.	inches	mm.	inches	KG	LBS	N.
5000/P	120-160	2444	96,22	4982	196,14	2560	5643	104

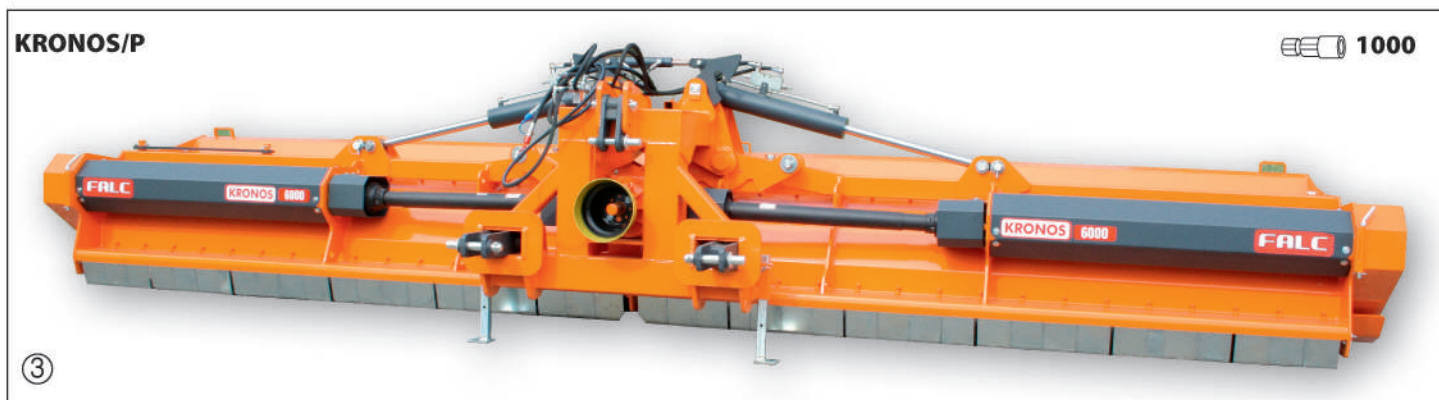
Kronos 6000/P								
	HP.	mm.	inches	mm.	inches	KG	LBS	N.
6000/P	120-200	2473	97,36	6096	240,00	3250	7165	136



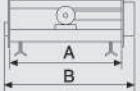

SHREDDER with auger - HÄCKSLER mit Schnecke ИЗМЕЛЬЧИТЕЛЬ со шнеком - KLEPELMAAIER met zijafvoer

Fast								
	HP.	A mm.	B	A inches	B	KG	LBS	N.
4800 DT	120-180	4821	5310	189,80	209,05	3600	7396	104





 FAST shredder allows to shred and windrow stalks in one pass. Uniform windrows are ready for baling. It is possible to lay a second windrow adjacent to the first one. In a short time, it is easy to convert FAST into a standard shredder with unload of the chopped material on the ground.



 Der Häcksler FAST schneidet und bündelt das geschnittene Material in einem Durchgang. Die so entstandenen Bündel sind fertig zum Verpacken. Wenn notwendig kann ein zweites Bündel neben dem ersten erstellt werden. Es ist möglich FAST in einen normalen Häcksler schnell umzuwandeln mit Ausladung des Materiales am Boden.

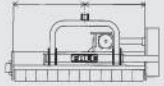

 Измельчители FAST измельчают и сразу укладывают измельченную траву в валок. Валки сразу готовы для тюкования. Возможно укладывать второй валок рядом с первым. FAST быстро трансформируются в обычный измельчитель с разбрасыванием измельченной травы по полю.



 Vijzel klepelmaaier maakt het mogelijk om stelen in één keer te versnipperen en op zwad te leggen. Uniforme zwaden zijn klaar om te persen. Het is mogelijk om een tweede zwad naast het eerste te leggen. In korte tijd is het eenvoudig om FAST om te zetten in een standaardversnipperaar met het lossen van het gehakselde product op de grond.

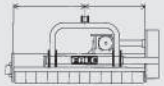

SHREDDERS for vineyards and orchards HÄCKSLER für Obstgarten und Weinbau ИЗМЕЛЬЧИТЕЛИ для садов и виноградников KLEPELMAAIERS voor wijngaarden en boomgaarden



Cat						N.
	HP.	mm.	inches	KG	LBS	
800 F *	20-60	814	32,05	260	573	10
1000 F *	20-60	1027	40,43	280	617	14
1200 F *	20-60	1240	48,82	300	661	16
1350 F - SP	20-60	1382	54,41	353	778	18
1500 F - SP	20-60	1524	60,00	374	824	20
1800 F - SP	20-60	1808	71,18	417	919	24
2100 SP	20-60	2092	82,36	468	1032	28
2500 SP *	20-60	2518	99,13	550	1213	34

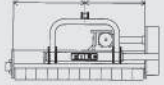

 540

 ①

Condor						N.
	HP.	mm.	inches	KG	LBS	
1400 SP	50-70	1405	55,31	495	1091	14
1600 F - SP	50-70	1585	62,40	515	1135	16
1800 F - SP	50-70	1765	69,48	545	1202	18
2100 SP	50-70	2125	83,66	600	1323	22
2300 SP	50-70	2305	90,74	635	1400	24
2700 SP	50-70	2665	104,92	690	1521	28

 540

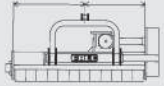
 ②

Beta						N.
	HP.	mm.	inches	KG	LBS	
1200 SP	50-90	1225	48,22	540	1190	12
1400 SP	50-90	1405	55,31	610	1345	14

 540

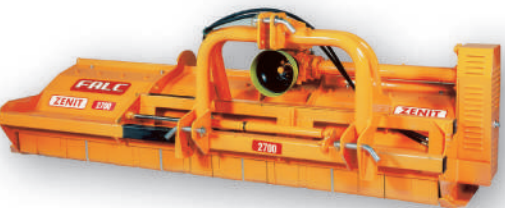
 ③

Zenit						N.
	HP.	mm.	inches	KG	LBS	
1600 F - SP	50-90	1585	62,40	660	1455	16
1800 F - SP	50-90	1765	69,48	720	1587	18
2100 F - SP	50-90	2125	83,66	800	1764	22
2300 F - SP	60-90	2305	90,74	850	1874	24
2500 F - SP	60-90	2485	97,83	910	2006	26
2700 F - SP	60-90	2665	104,92	990	2183	28
3000 F - SP	60-90	3025	119,09	1090	2403	32





 540

 ④



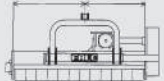

 **F:** fix, **SP:** with hydraulic side shift - * ON REQUEST  **F:** fix, **SP:** mit hydraulischer Verschiebung - * AUF WUNSCH



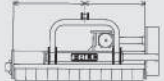

 **F:** фиксированные **SP:** с гидравлическим смещением - * ПО ЗАПРОСУ



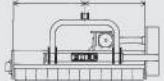

 **F:** Snelkoppeling, **SP:** Met hydraulische side shift - * OP AANVRAAG

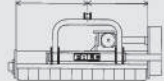

Front and back SHREDDERS - Front und Heckanbau HÄCKSLER ИЗМЕЛЬЧИТЕЛИ передние и задние - Voor en achter KLEPELMAAIERS

Cat Avant							540	
	HP.	mm.	inches	KG	LBS	N.		
1500	40-60	1524	60,00	415	914	20	①	
1800	40-60	1808	71,18	458	1010	24		

Condor Avant							540 - 1000	
	HP.	mm.	inches	KG	LBS	N.		
1800	50-90	1765	69,49	610	1345	18	②	
2100	50-90	2125	83,66	660	1455	22		
2700	50-90	2665	104,92	760	1676	28		

Zenit Avant							1000	
	HP.	mm.	inches	KG	LBS	N.		
2100	80-100	2125	83,66	827	1823	22	③	
2300	80-100	2305	90,74	860	1896	24		
2500	80-100	2485	97,83	910	2006	26		
2700	80-100	2665	104,92	960	2116	28		
3000	80-100	3025	119,09	1030	2271	32		

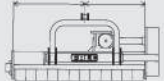
Super Sax							540	
	HP.	mm.	inches	KG	LBS	N.		
1500	50-100	1471	57,91	750	1654	12	④	
1600	50-100	1594	62,75	760	1676	12		
1800	55-100	1840	72,44	810	1786	14		
2100	60-100	2086	82,12	860	1896	16		

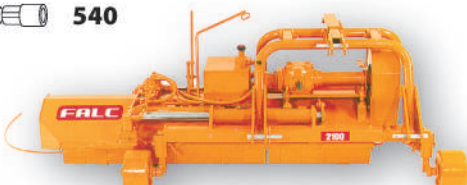
Sonar							540	
	HP.	mm.	inches	KG	LBS	N.		
1800	40-90	1801	70,90	640	1410	24	⑤	
2100	40-90	2085	82,08	680	1499	28		



The shredders "AVANT", SUPER SAX and SONAR can be coupled in front and in the back of the tractor



Die Häcksler "AVANT", SUPER SAX und SONAR sind für Front und Heckanbau.







Измельчители моделей "AVANT", SUPER SAX и SONAR могут крепиться к трактору как сзади, так и спереди.



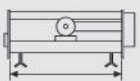



Klepelmajers "AVANT", SUPER SAX en SONAR geschikt voor in de fronthead en achterthead.

Lateral SHREDDERS - Seitenhäcksler ИЗМЕЛЬЧИТЕЛИ боковые - ZIJKLEPELMAAIERS

Master Special						
	HP.	mm.	inches	KG	LBS	N.
1600	50-80	1666	65,59	600	1323	22
1800	50-80	1808	71,18	620	1367	24
2100	50-80	2092	82,36	660	1455	28







New
①  540

Master Special Out						
	HP.	mm.	inches	KG	LBS	N.
1800	50-80	1808	71,18	670	1478	24
2100	50-80	2092	82,36	710	1566	28







New
②  540

Master						
	HP.	mm.	inches	KG	LBS	N.
1600	80-90	1585	62,40	750	1654	16
1800	80-100	1765	69,48	790	1742	18
2100	80-120	2125	83,66	900	1985	22

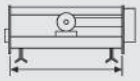





New
③  540

Master Super						
	HP.	mm.	inches	KG	LBS	N.
1600	80-90	1585	62,40	850	1874	16
1800	80-100	1765	69,49	920	2028	18
2100	80-120	2125	83,66	980	2160	22
2500	100-150	2485	97,83	1130	2491	26







New
④  540

TLF					
	HP.	PTO	KG	LBS	N.
1600	70-120	540	990	2182	48
2000	70-120	540	1070	2358	60
2500	90-120	1000	1320	2910	78







⑤  540 - 1000

SHREDDERS with collector - HÄCKSLER mit Krautfänger ИЗМЕЛЬЧИТЕЛЬ с подборщиком - KLEPELMAAIER met opvangbak

Jolly						Collector	
	HP.	mm.	inches	KG	LBS	m ³	N.
1350	40-70	1382	54,40	650	1433	1,00	18
1650	40-70	1666	65,59	730	1609	1,20	22







1 

Solex						Collector	
	HP.	mm.	inches	KG	LBS	m ³	N.
1500	70-90	1524	60,00	970	2138	1,56	20
1800	80-90	1808	71,18	1090	2403	1,86	24
2100	80-90	2092	82,36	1200	2646	2,16	28



2 





Vortex						Collector	
	HP.	mm.	inches	KG	LBS	m ³	N.
2100	100-140	2125	83,66	1430	3153	2,33	22







3 







Special SHREDDER - Spezielle HÄCKSLER специальные ИЗМЕЛЬЧИТЕЛИ - Speciale KLEPELMAAIERS





Lince							1000	
	HP.	mm.	inches	KG	LBS	N.		
2300 *	100-160	2305	90,75	1680	3704	48	①	





 * ON REQUEST -  * AUF WUNSCH -  * ПО ЗАПРОСУ -  * OP AANVRAAG

Top							1000	
	HP.	mm.	inches	KG	LBS	N.		
2700 *	110-160	2665	104,92	1800	3968	28	②	
3200 *	110-160	3205	126,18	2020	4453	34		

 * ON REQUEST -  * AUF WUNSCH -  * ПО ЗАПРОСУ -  * OP AANVRAAG



Spit Green							540	
	HP.	mm.	inches	KG	LBS	N.		
1200	50-70	1240	48,81	470	1036	16	⑤	
1350	50-70	1382	54,40	510	1124	18		
1650	50-70	1666	65,59	560	1235	22		

Spit Green Vegetables							540	
	HP.	mm.	inches	KG	LBS	N.		
1800	50-90	1808	71,18	495	1091	24	⑥	

HYDRAULIC FORKLIFTS - HYDRAULIK STAPLER ГИДРАВЛИЧЕСКИЕ ПОДЪЕМНИКИ - HYDRAULISCHE HEFMAST

Mondial		Load capacity Hebegewicht Грузоподъёмность Laadcapaciteit	Lifting height Hebe hohe Высота подъема Hefhoogte	Forks forwards backwards Vorn und zurück Schwenbar Наклон вперед назад Voor en achter over verstellen van de hefmast	Side-translator Seitenverstellung Боковое Смещение Side shift
	KG	KG	mm.		mm.
3200	440	1500	3200	12°-17°	100+100



Triplex		Load capacity Hebegewicht Грузоподъёмность Laadcapaciteit	Lifting height Hebe hohe Высота подъема Hefhoogte	Forks forwards backwards Vorn und zurück Schwenbar Наклон вперед назад Voor en achter over verstellen van de hefmast	Side-translator Seitenverstellung Боковое Смещение Side shift
	KG	KG	mm.		mm.
2500	440	1500	2500	12°-17°	100+100
3200	510	1500	3200	12°-17°	100+100
3800	570	1500	3800	12°-17°	100+100

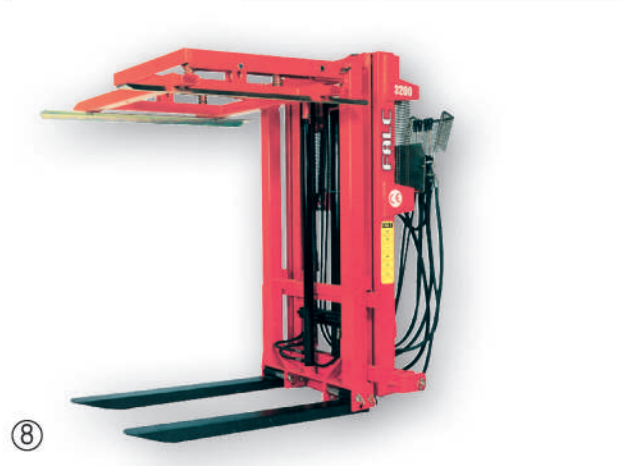

NOTES

A series of horizontal dotted lines for writing notes.



FALC was established in 1960 by the present managing director, PIERO ZAMA, in order to produce a completely new and innovative agricultural machine, the digging machine, which was planned by the founder himself.

Today FALC is a limited company and ZAMA family owns at 100%.

The firm is located in FAENZA - Italy - over an area of 40.000 square meters; the production includes 66 different models of machines, divided into 220 versions, in order to offer the farmers from all over the world the best solutions for each type of cultivation.

At present the machines produced by FALC are delivered to more than 60 countries in the five continents.

85% of its sales revenue comes from exports.



Das Unternehmen FALC wurde 1960 von seinem derzeitigen Präsidenten PIERO ZAMA gegründet, mit dem Ziel, eine völlig neue und innovative Landmaschine herzustellen, die von seinem Gründer selbst konzipiert war: die Spatenmaschine.

Heute ist FALC eine GmbH, zu 100% im Besitz der Familie ZAMA. Sitz des Unternehmens ist FAENZA - ITALIEN.

Der Betrieb befindet sich auf einer Gesamtfläche von 40.000 m², die Produktion umfasst 66 verschiedene Maschinenmodelle, die wiederum in 220 Versionen unterteilt sind, um den Landwirten in aller Welt optimale Lösungen für alle Anbauarten bieten zu können. Die von FALC hergestellten Maschinen werden in 60 Länder auf allen fünf Kontinenten geliefert. Der Umsatz der exportierten Maschinen beläuft sich auf 85% vom Gesamtumsatz.



FALC была основана в 1960 году действующим президентом PIERO ZAMA, с целью создания совершенно новой и инновационной сельскохозяйственной машины, разработанной самим основателем: почворыхлителя.

Сегодня FALC - это ООО и 100% акций принадлежит семье ZAMA. Фабрика находится в городе FAENZA, в Италии.

Современное здание фабрики располагается на площади в 40.000 м². Линейка продукции включает в себя 66 разных моделей техники, которые в свою очередь подразделяются на более чем 220 версий. Машины, производимые FALC, сегодня продаются в более чем 60 странах мира на пяти континентах. Доля экспорта достигает 85% от общего оборота.



FALC is opgericht in 1960 door directeur, PIERO ZAMA, om een machine te ontwikkelen een volledig nieuwe en innovatieve landbouwmachine, de spitmachine, die was bedoeld voor zichzelf.

Vandaag is FALC een naamloze vennootschap en de ZAMA-familie is 100% eigenaar.

Het bedrijf is gevestigd in FAENZA - Italië - over een oppervlakte van 40.000 vierkante meter; de productie omvat 66 verschillende modellen van machines, verdeeld in 220 versies, om de boeren van over de hele wereld de beste oplossingen te bieden voor elk type teelt.

Momenteel zijn de machines die door FALC geproduceerd worden, geleverd aan meer dan 60 landen op de vijf continenten. 85% van de omzet komt uit de export.

FALC

FALC SRL
Via Proventa, 41
48018 FAENZA (RA)
ITALIA

Tel. +39 0546 29050
Fax +39 0546 663986

info@falc.eu
www.falc.eu



The technical data, features and pictures are indicative and do not bind the manufacturer.

Die technische Angaben die Merkmale und die Bilder sind weisend und verbinden nicht den Hersteller.

Технические данные, характеристики и иллюстрации носят ознакомительный характер и не являются обязательными для производителя.

De technische data en afbeeldingen kunnen afwijken, de fabrikant is niet aansprakelijk.



www.falc.eu